

# 1

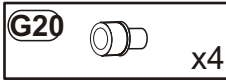

# 2

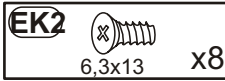
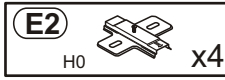
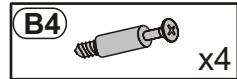
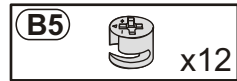
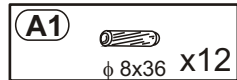
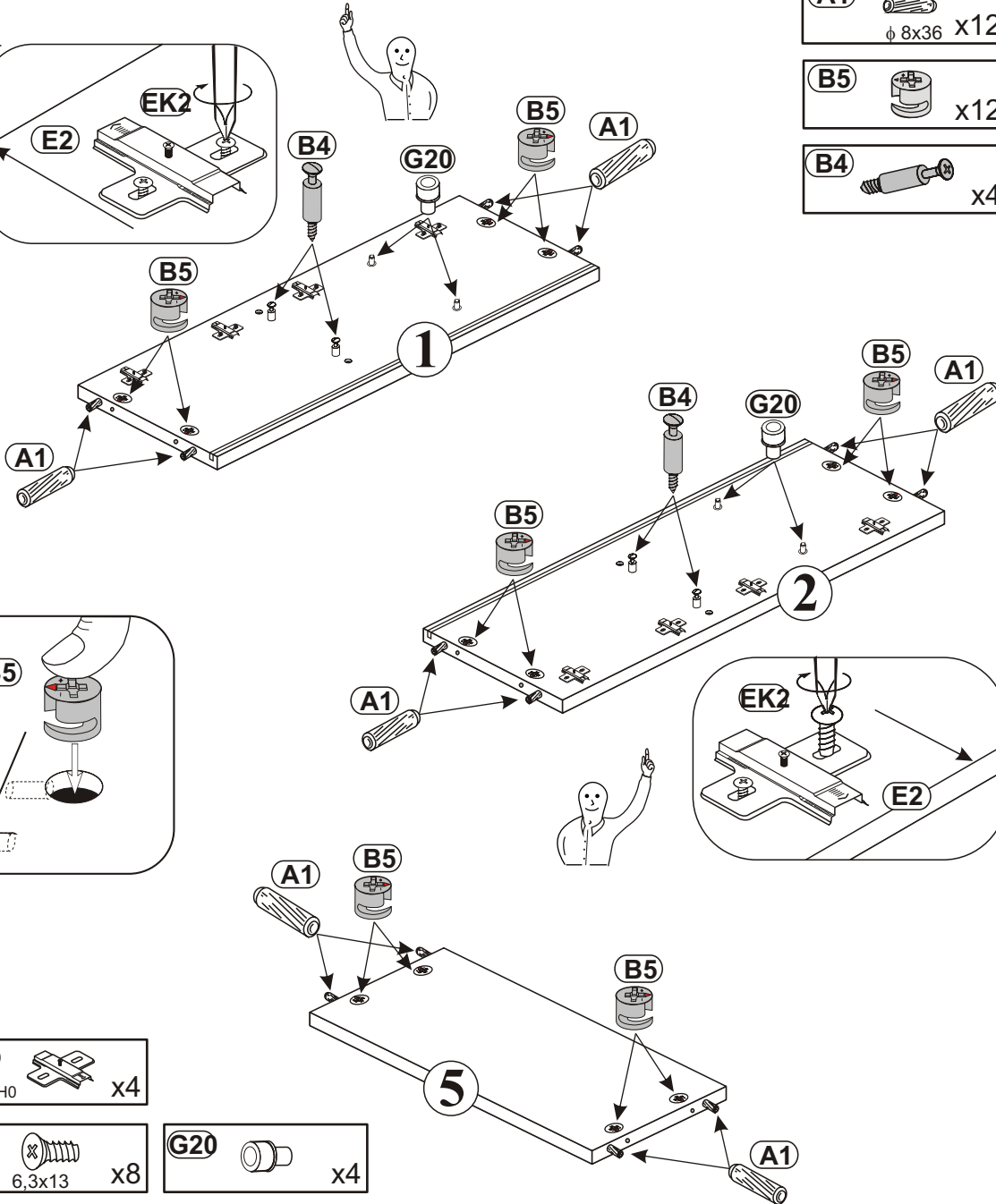
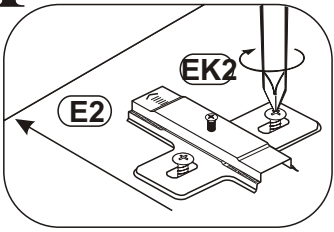
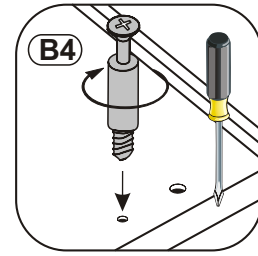
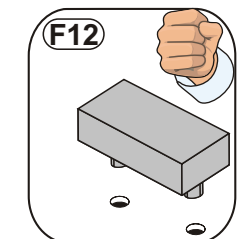
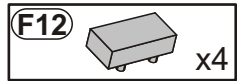
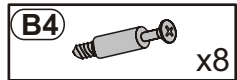
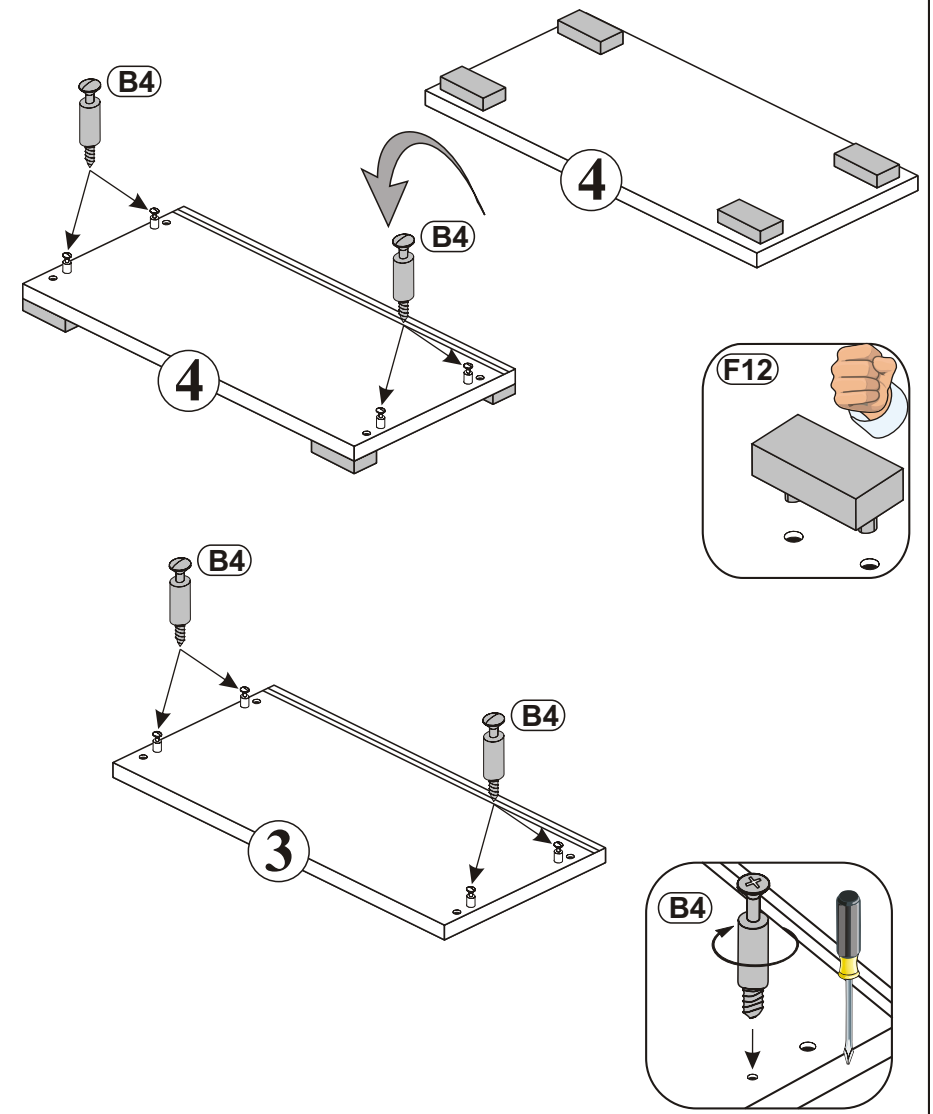

# ALLEPO

# TYP 40

### 3

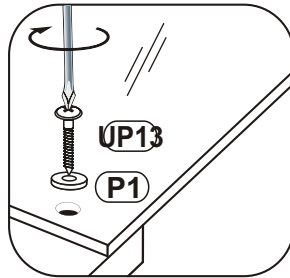
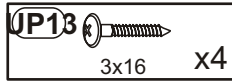
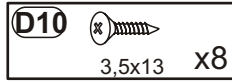
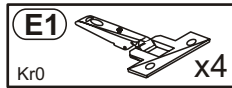
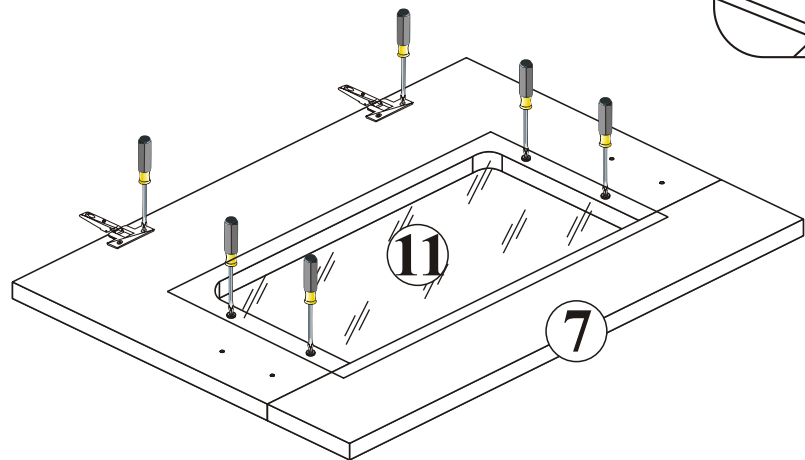
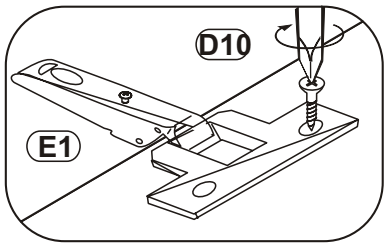
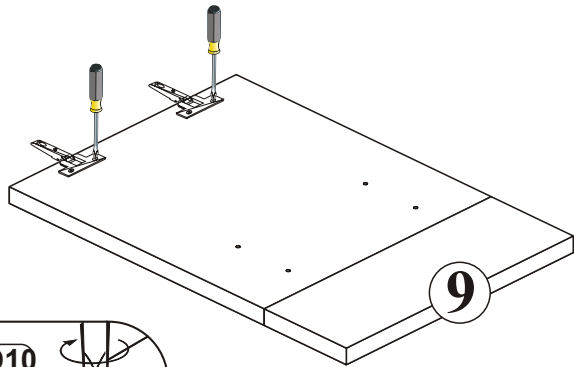

# 24 \_\_ AL

4/7

### 4

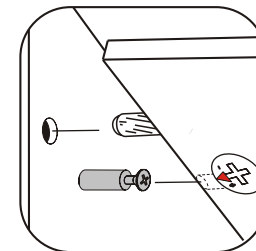
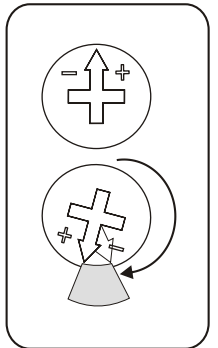
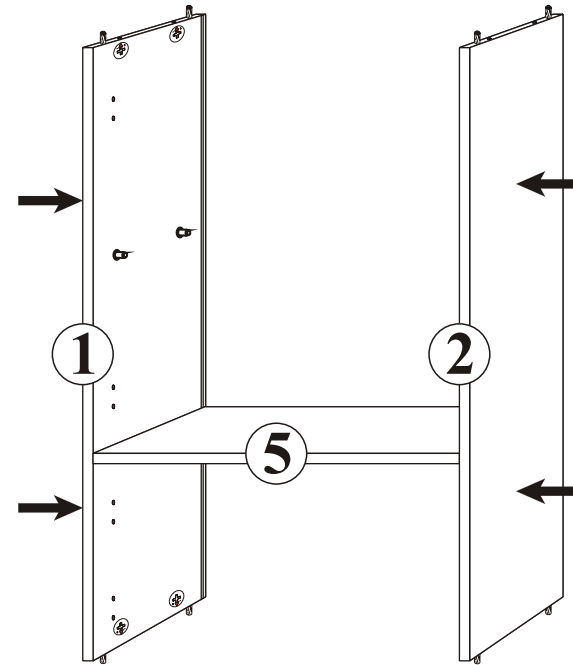

5

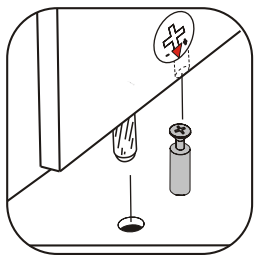
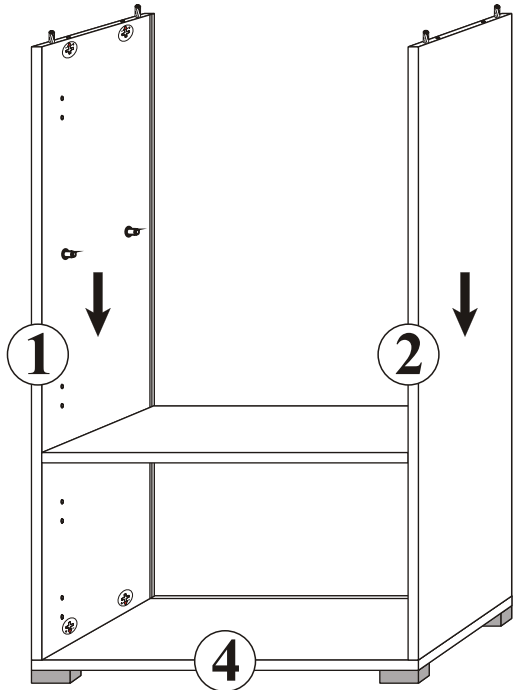

6

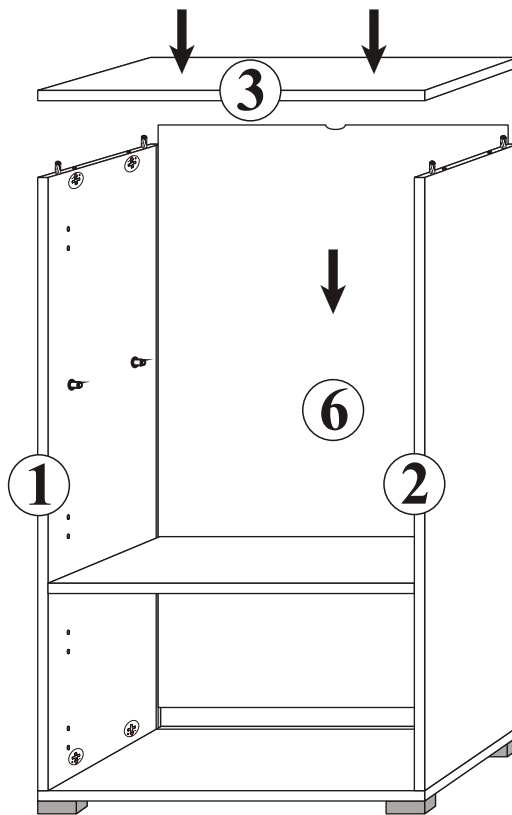
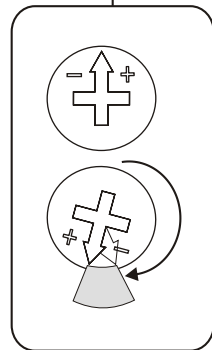
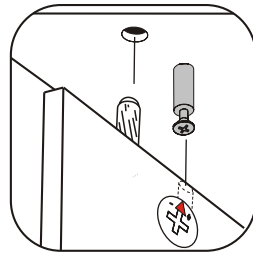

7



a=b

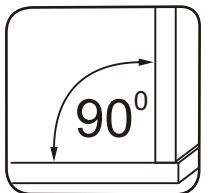
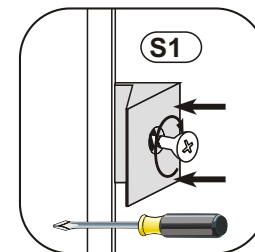
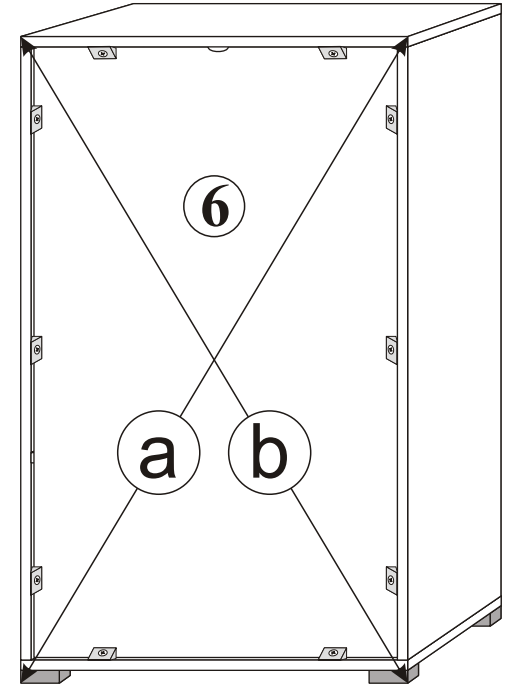

## 8

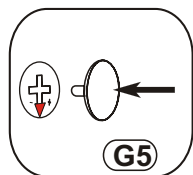
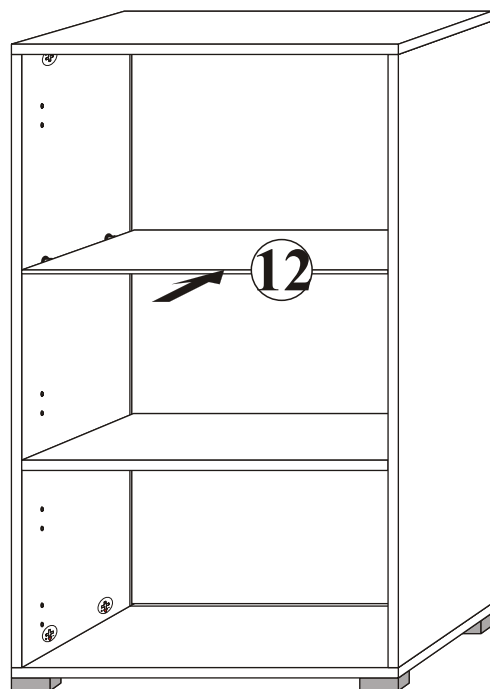
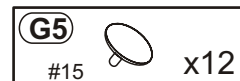

## 9

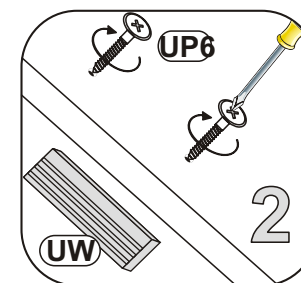
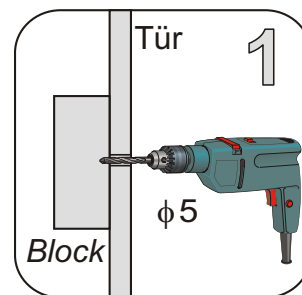
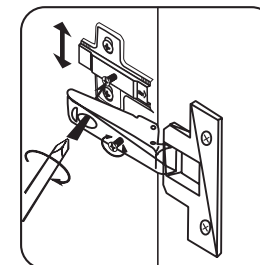
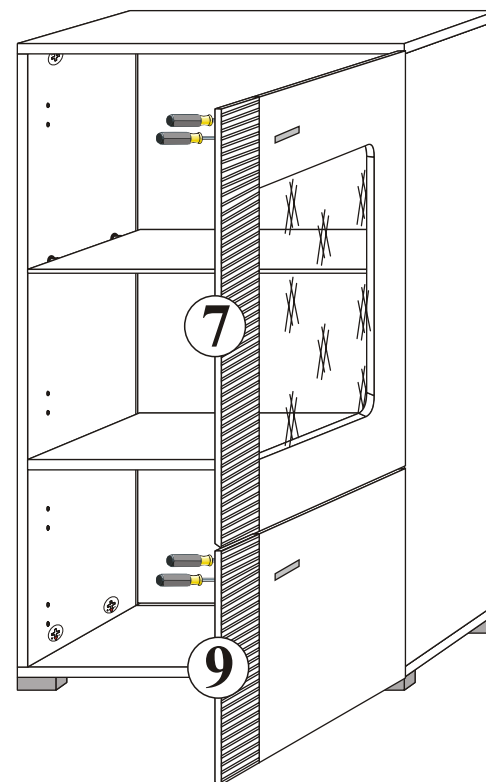
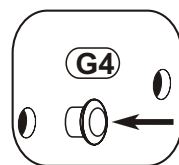
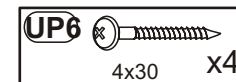
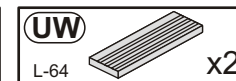
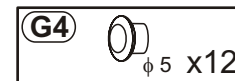

## 10

