

1

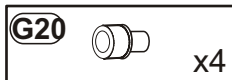

2

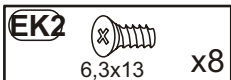
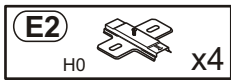
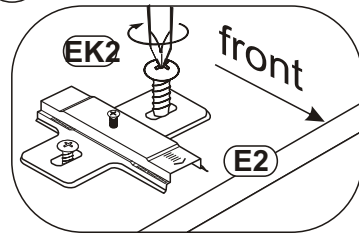
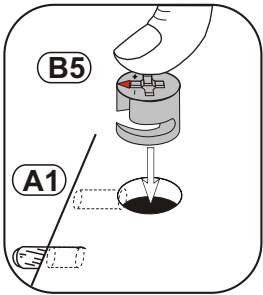
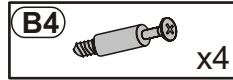
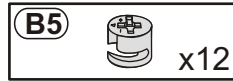
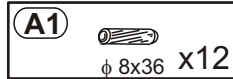
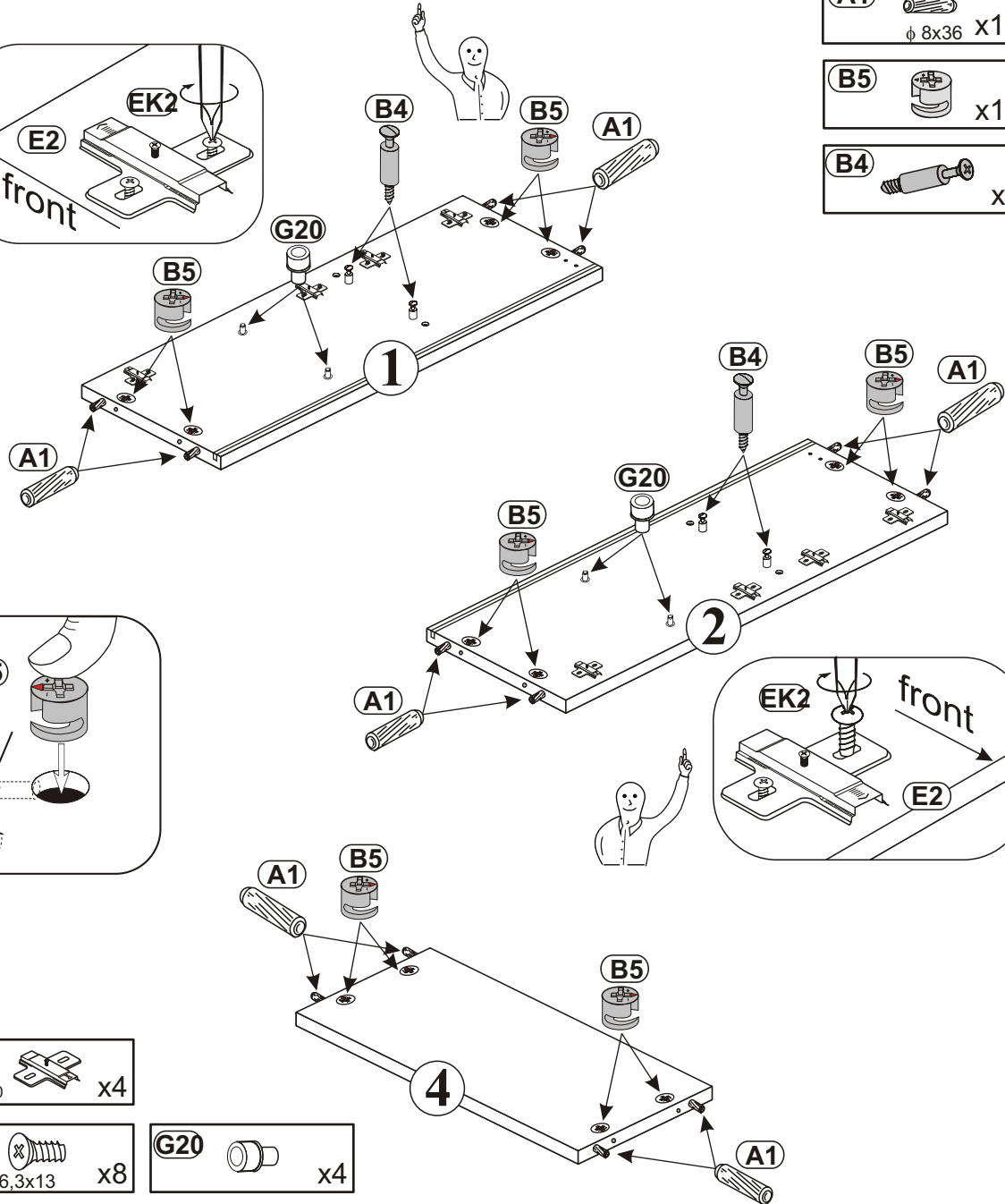
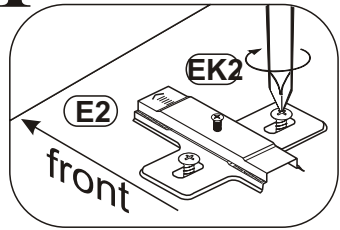
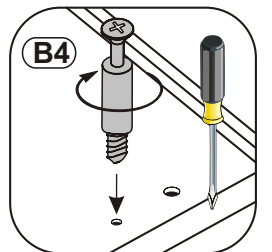
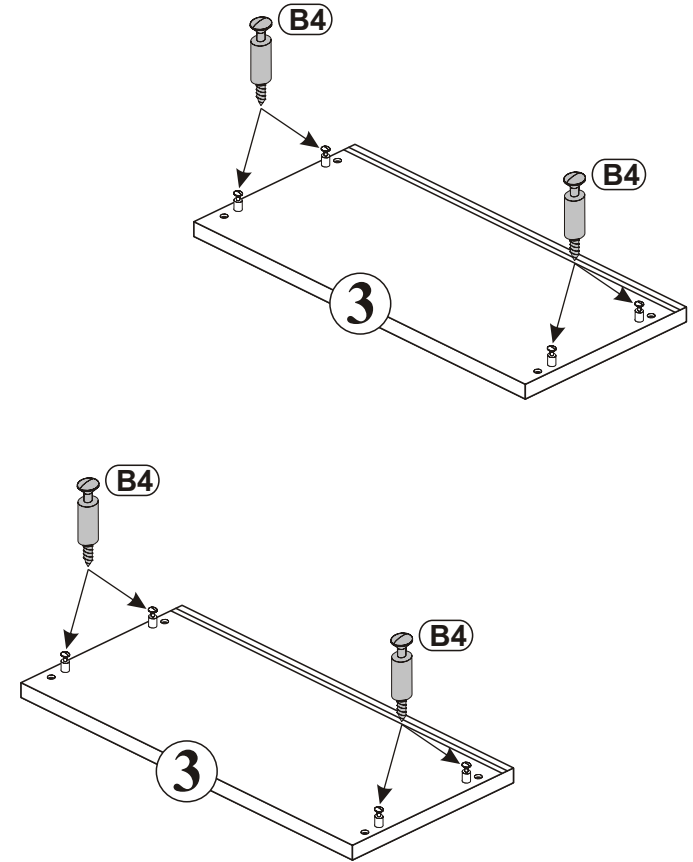
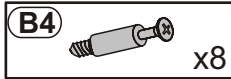

3

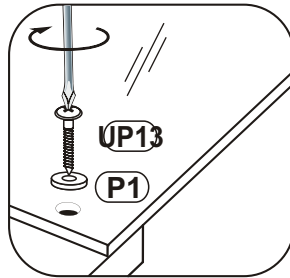
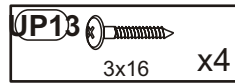
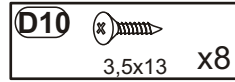
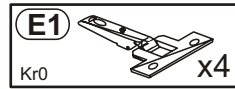
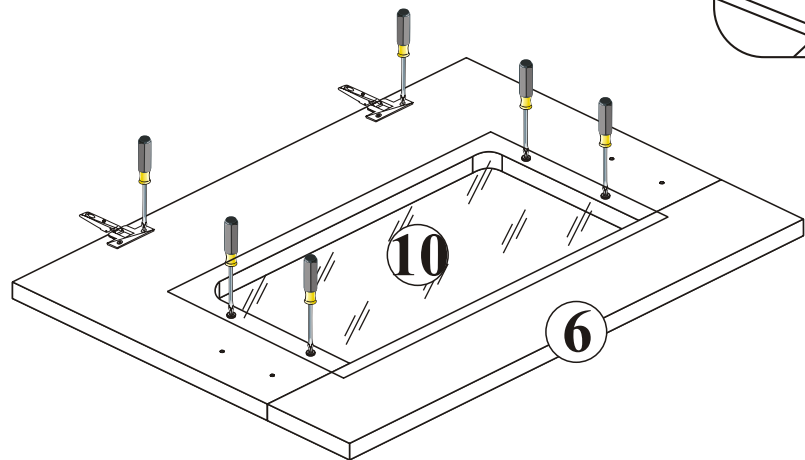
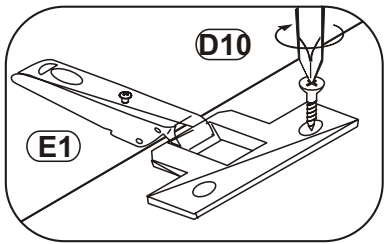
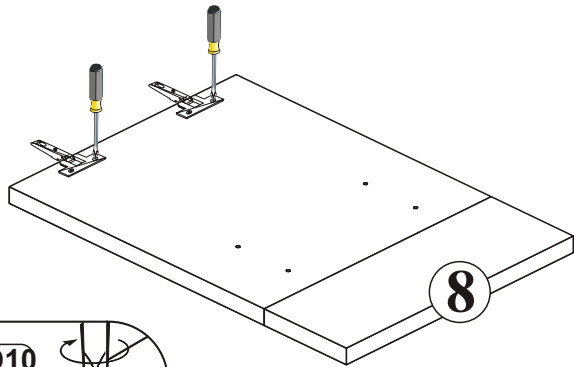

4

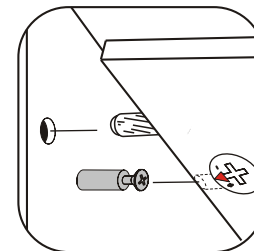
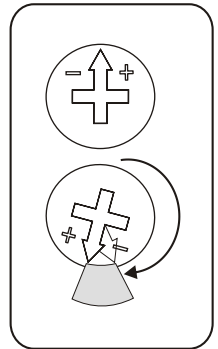
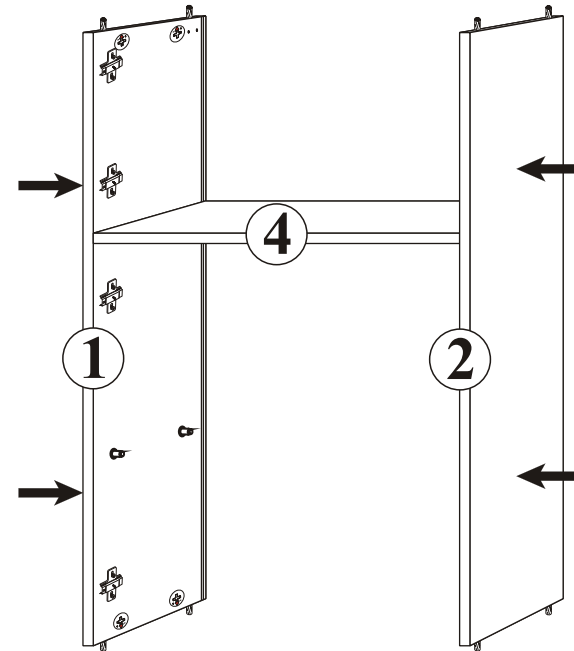

5

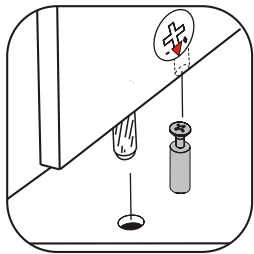
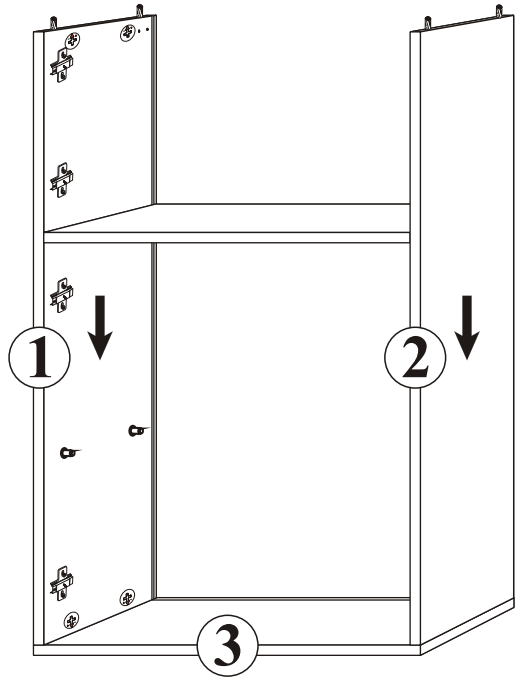

6

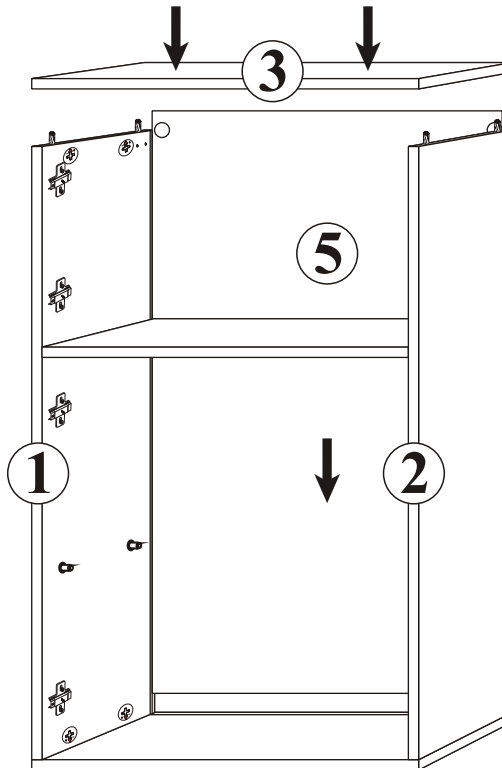
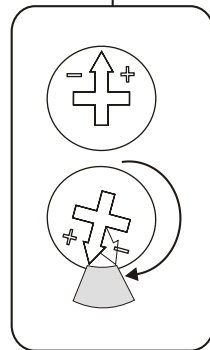

7



a=b

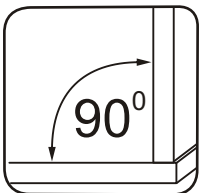
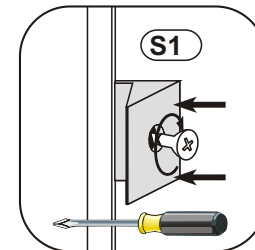
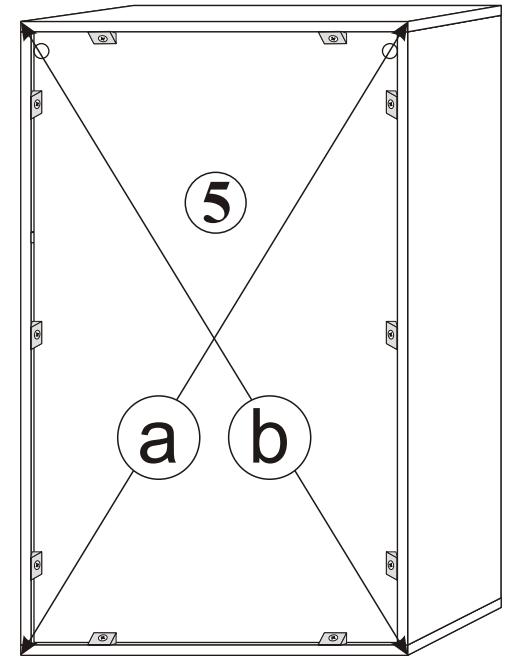

8

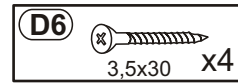
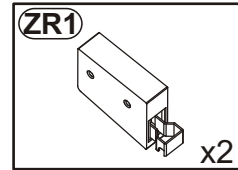
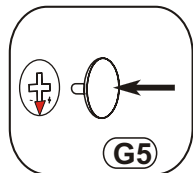
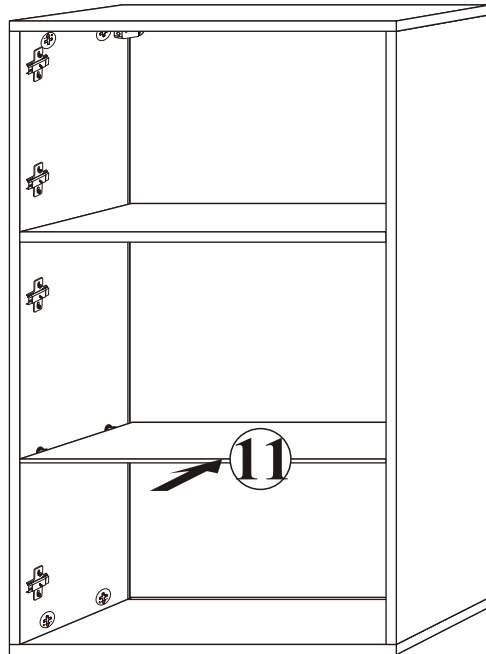
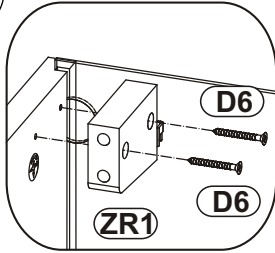

9

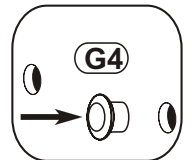
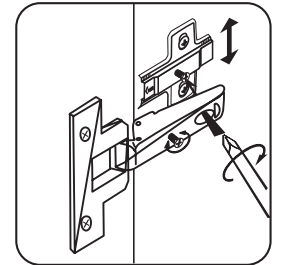
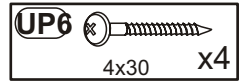
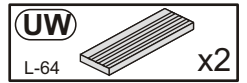
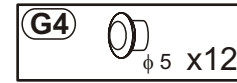
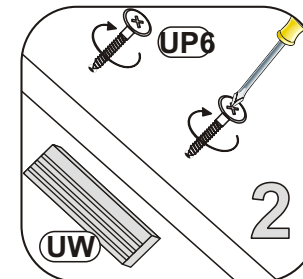
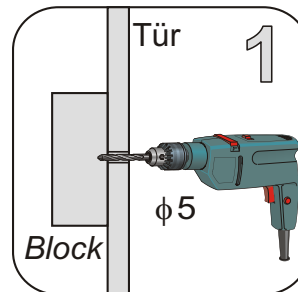
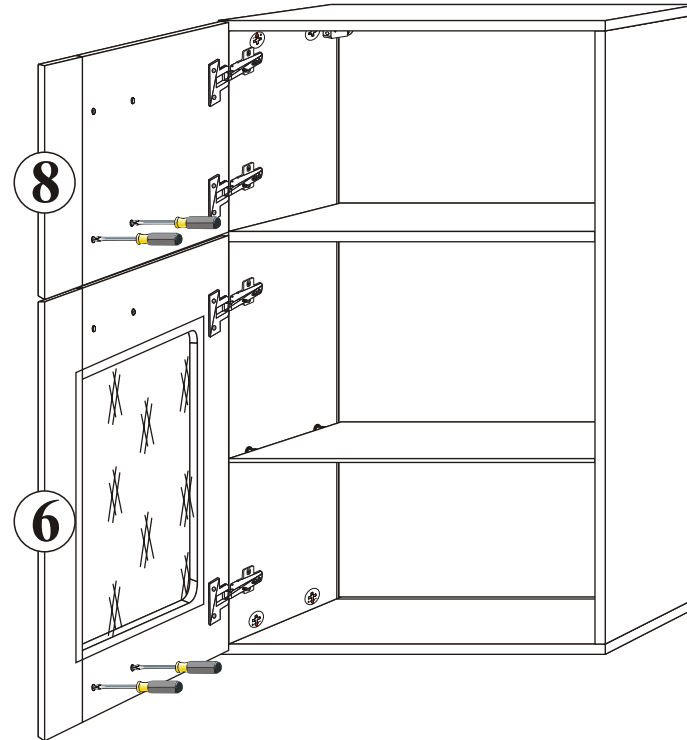

10

