

BOGOTA 20_BA WSW

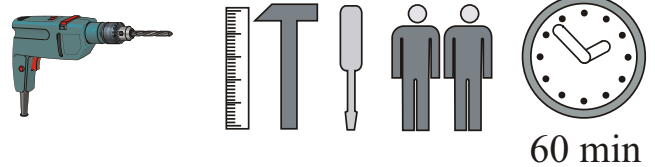
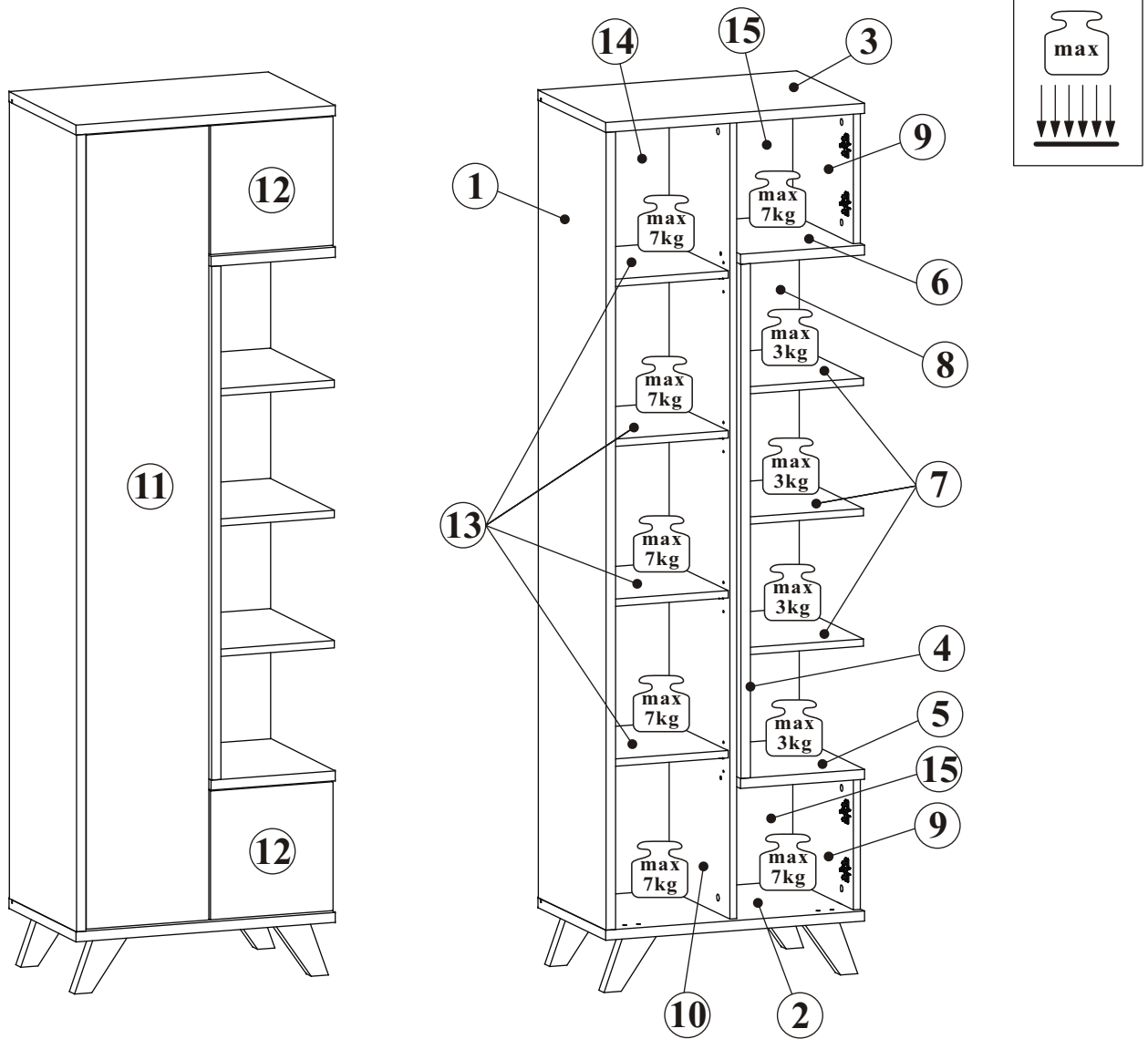

60 min

NO	Dim.			Col.-No	Qty
1	1756	400	22	2 / 2.	1
2	601	400	22	1 / 2.	1
3	601	400	22	1 / 2.	1
4	1132	383	22	1 / 2.	1
5	288	400	22	1 / 2.	1
6	288	400	22	1 / 2.	1
7	263	382	16	1 / 2.	3
8	287	1132	16	1 / 2.	1
9	290	378	16	2 / 2.	2
10	1756	358	16	2 / 2.	1
11	1750	284	16	2 / 2.	1
12	284	284	16	2 / 2.	2
13	274	348	16	1 / 2.	4
14	1768	288	3	2 / 2.	1
15	302	285	3	2 / 2.	2

BOGOTA 20__BA WSW

A1 x40 ø8x36	B4 x24	B5 x16 ø15x12	B16 x8 ø15x16	G5 x20	G7 x16
E1 x4 Ø26 H=0	E2 x4 H=0	E5 x4 Ø26 H=16	E4 x4 H=2	D10 x24 USØ3,5x13	OD1 x3
SK x4 H=120	B11 x22 Ø7x50	B14 x6 Ø7x60	G4 x22	G16 x4	UP13 x15 UPØ3x16
S1 x14	KR1 x1	L1 x1	G2 x1		

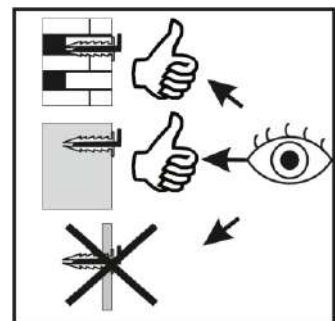
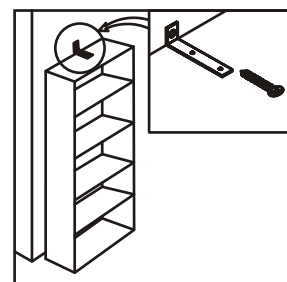
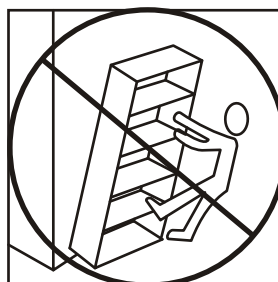
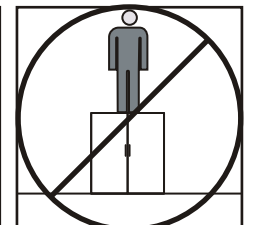
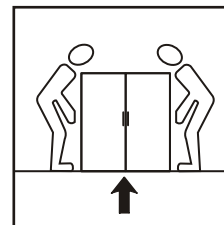
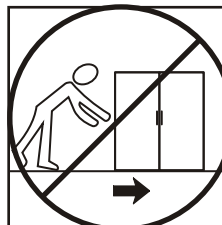
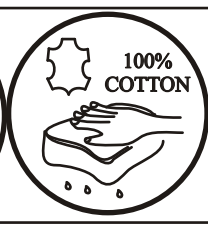
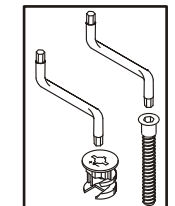
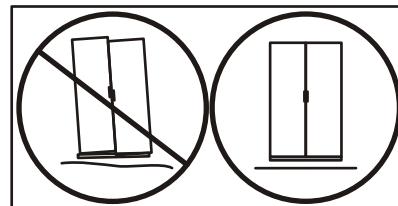
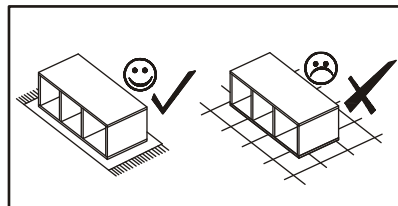
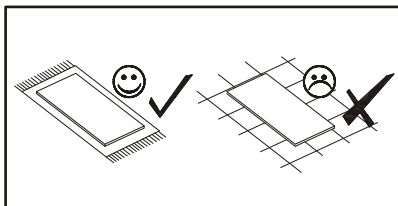
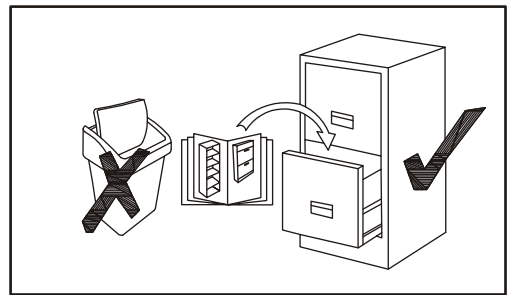
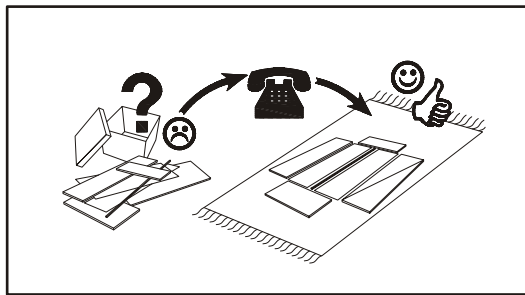
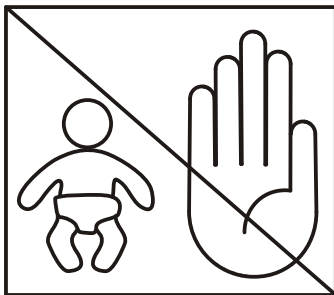
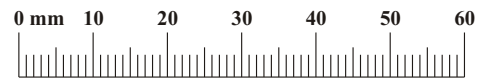

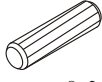

2

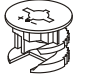
A1	
x8	ø8x36

B5	
x4	ø15x12

B16	
x4	Ø15x16

12mm		16mm	
	B5		B16

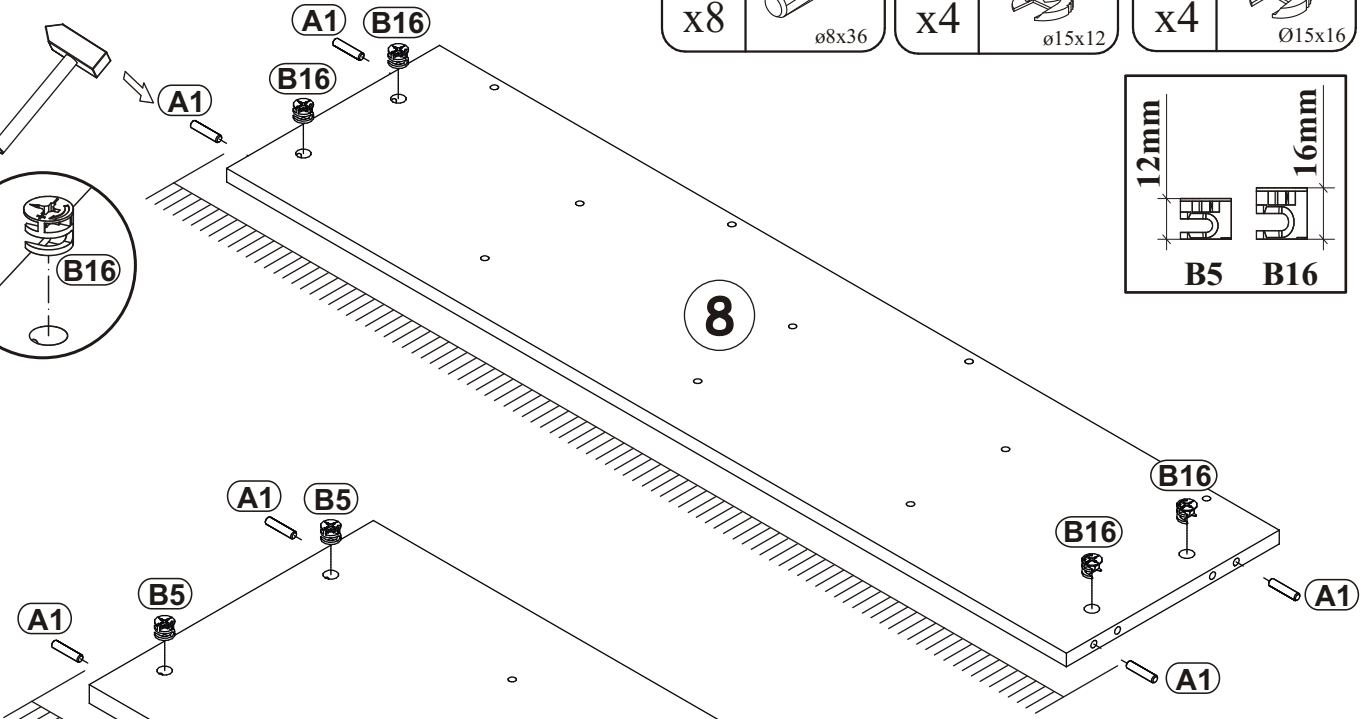
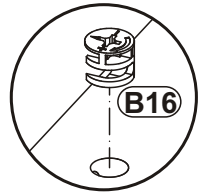

8

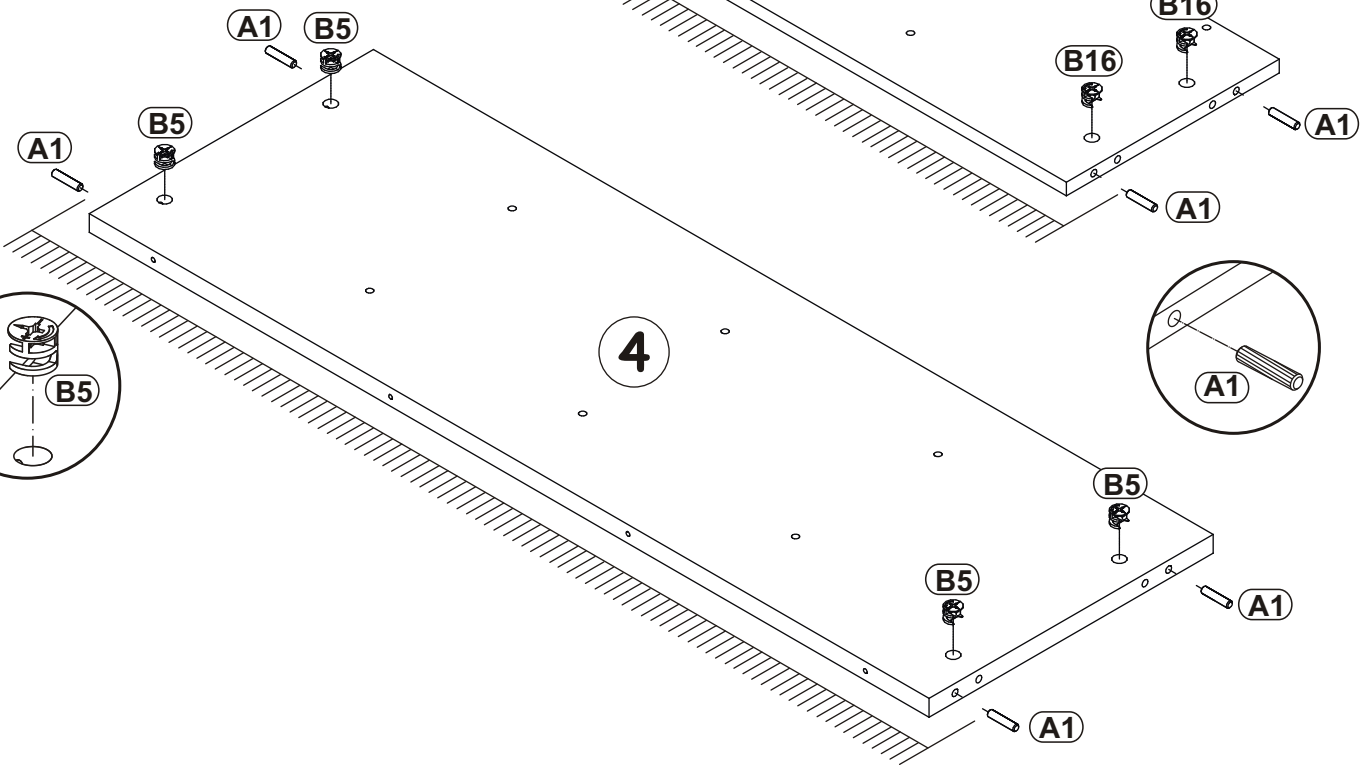
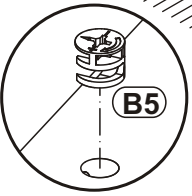

4

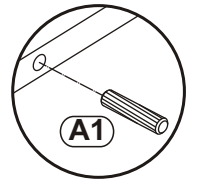

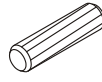

3

A1	
x8	ø8x36

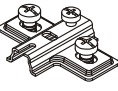
B5	
x8	ø15x12

E2	
x4	H=0

12mm		16mm	
	B5		B16

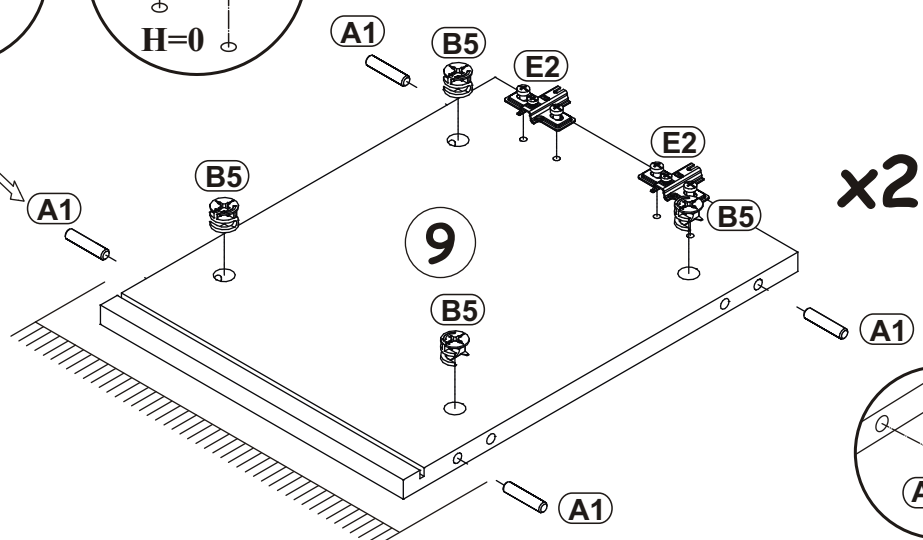
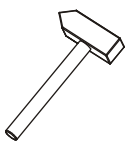
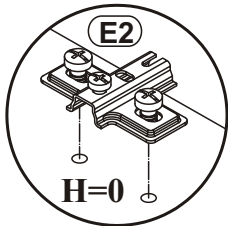
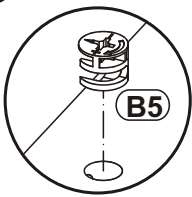

9

x2

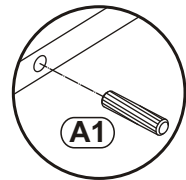

4

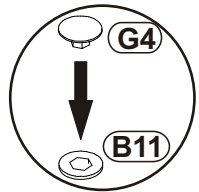
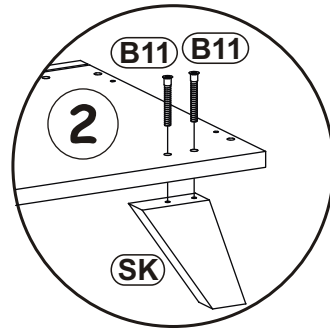
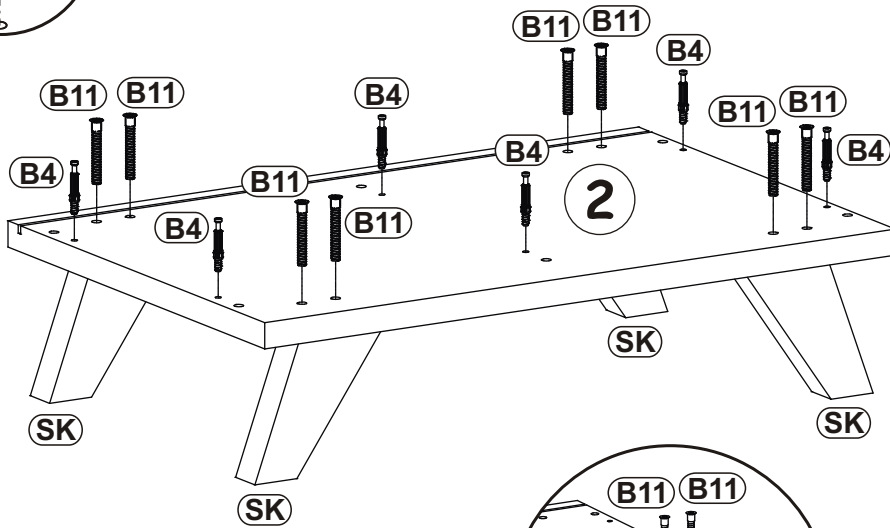
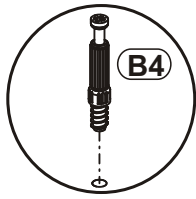
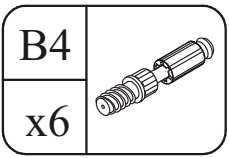
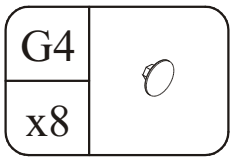
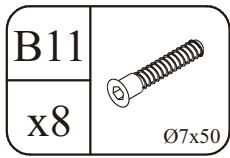
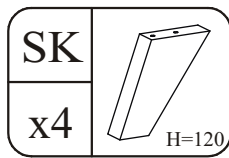

5

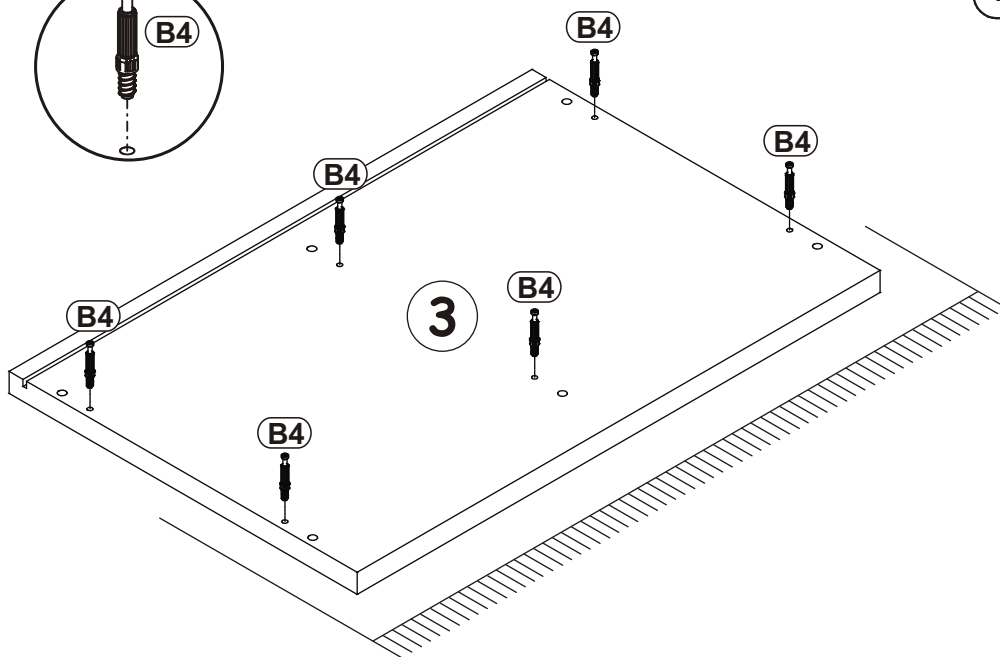
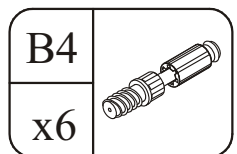
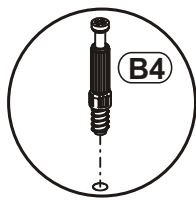

6

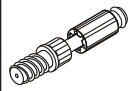
A1		B4	
x4	∅8x36	x12	

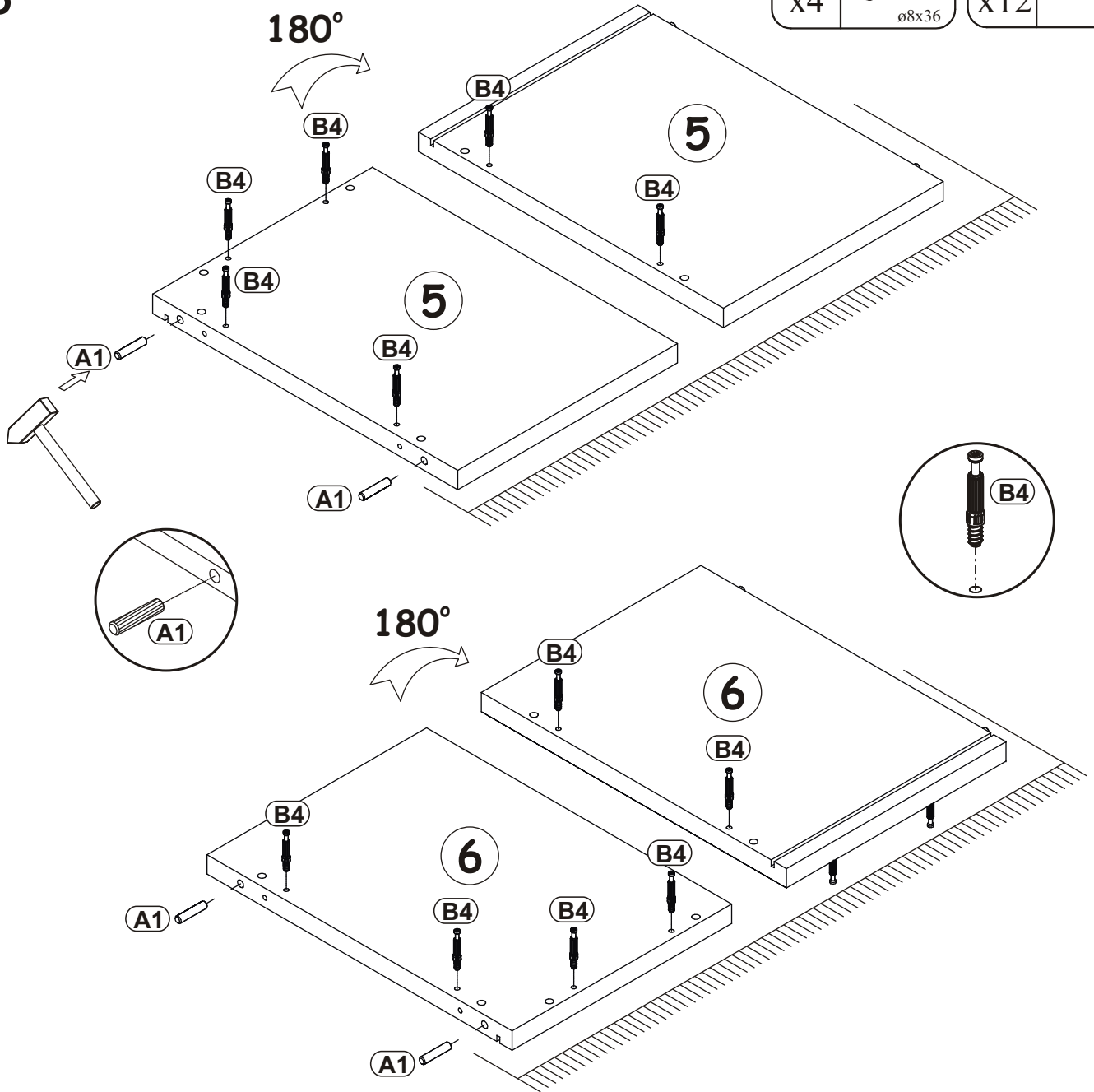

7

A1	
x12	∅8x36

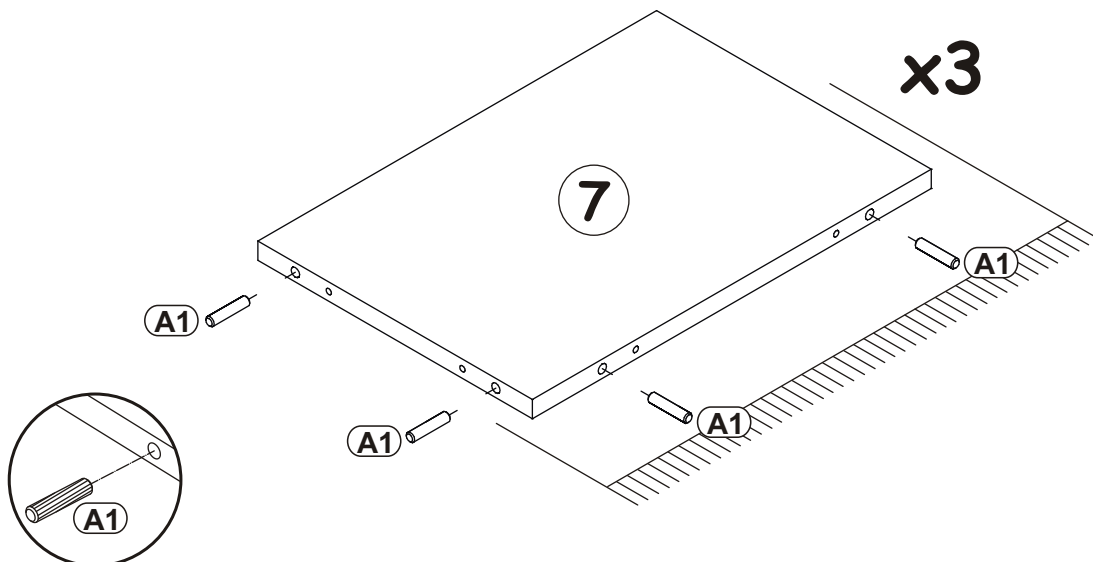

8

E5	Ø26 H=16
x4	

E1	Ø26 H=0
x4	

D10	
x16	USØ3,5x13

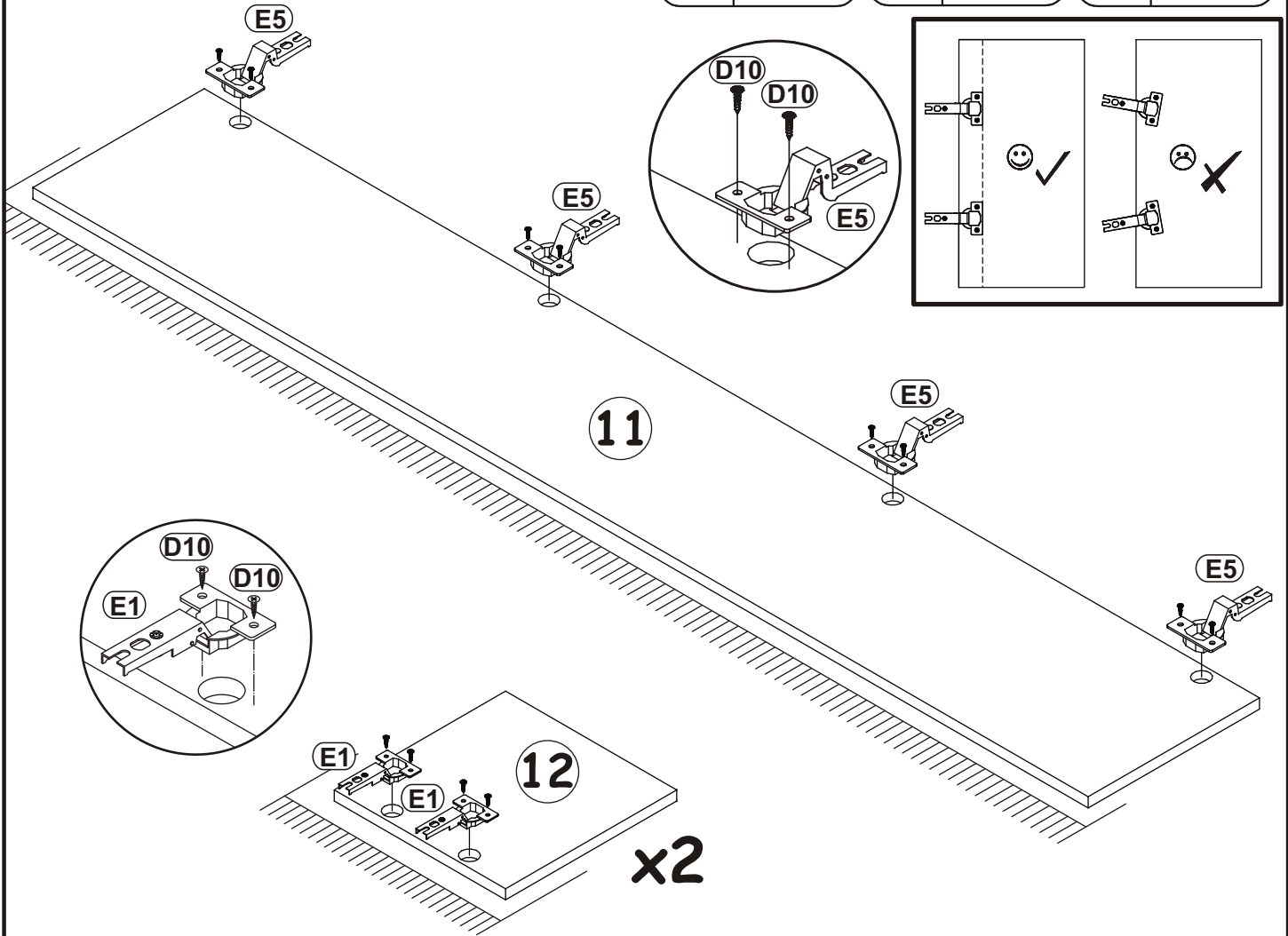

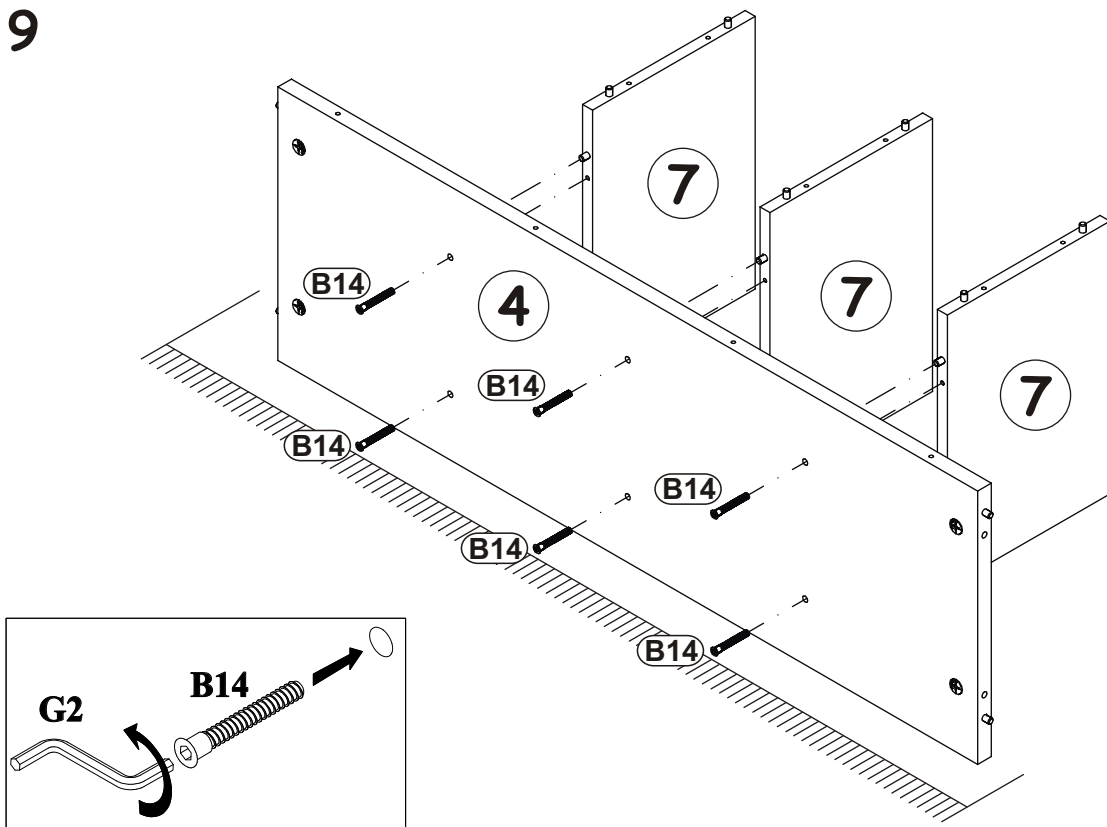

9

B14	
x6	Ø7x60



12

B11		G4		G5	
x4	Ø7x50	x4		x4	

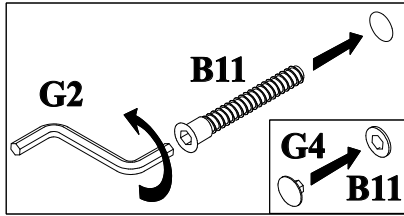
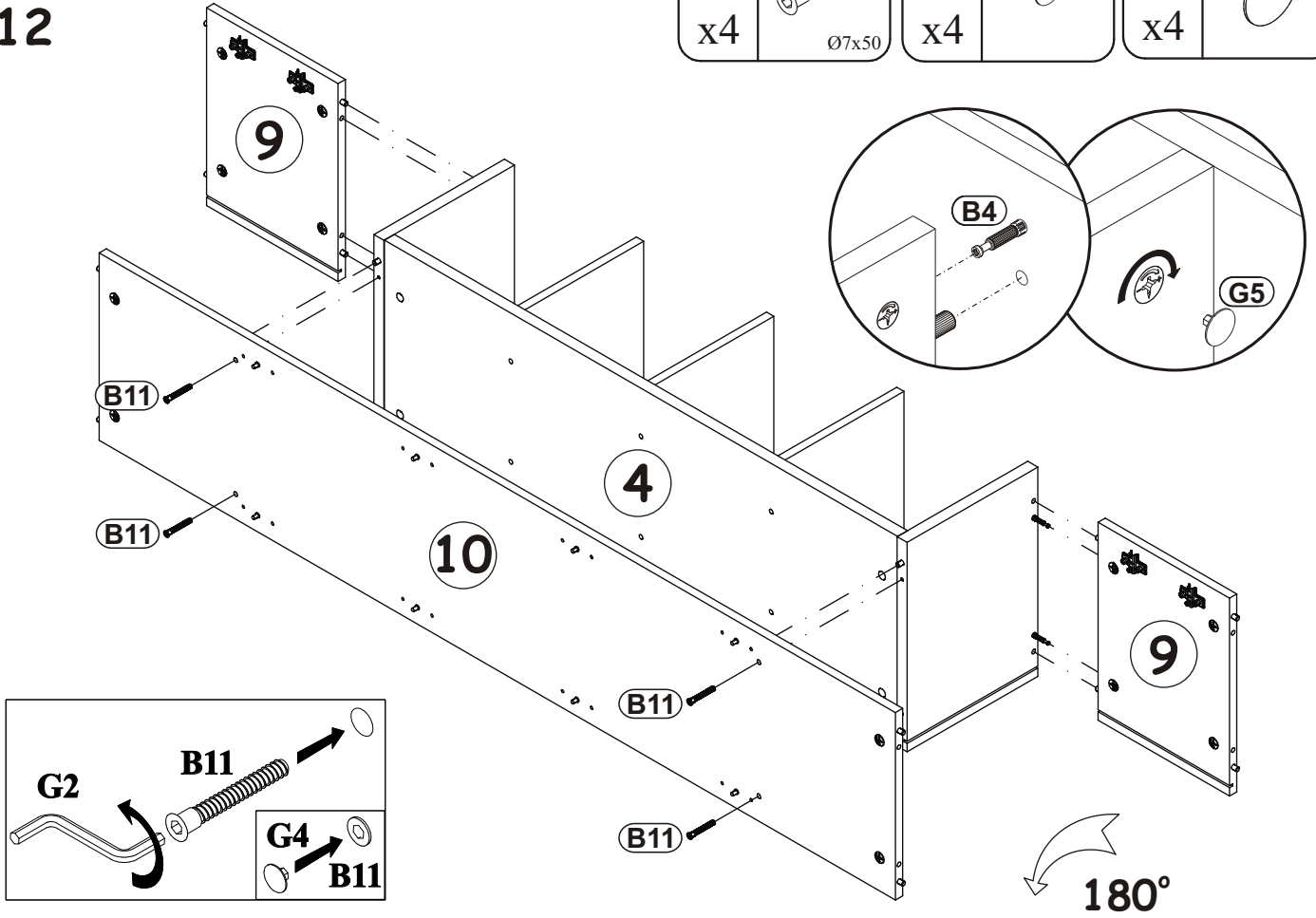

13

G5	
x6	

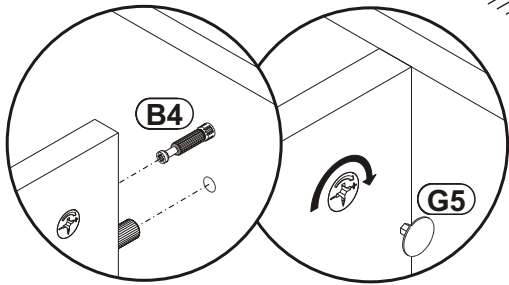
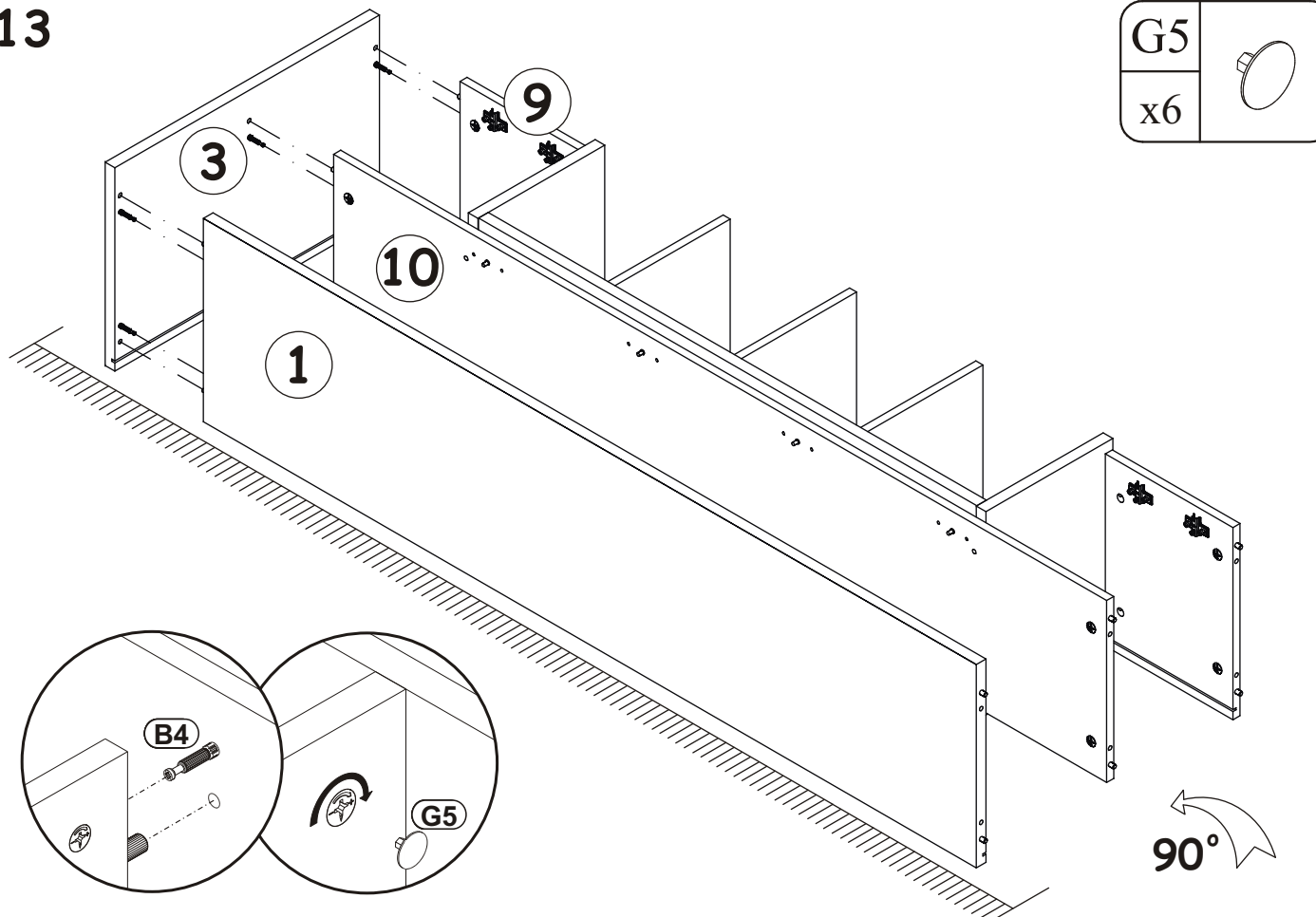

14

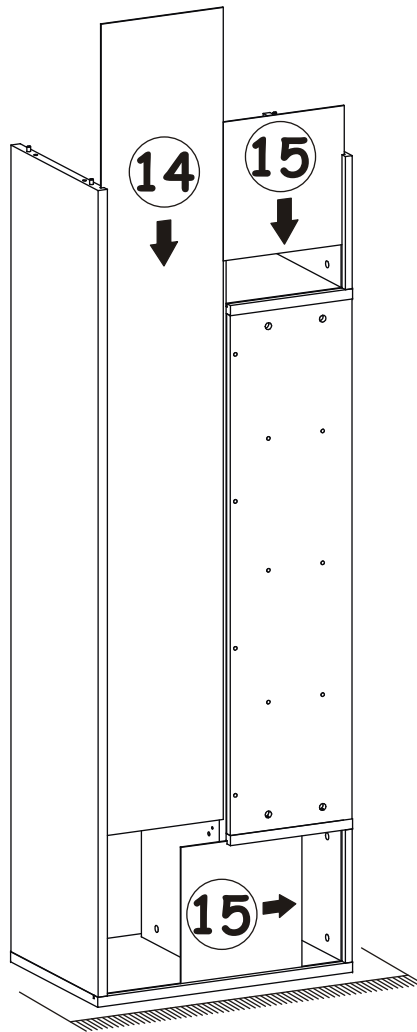

15

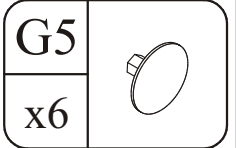
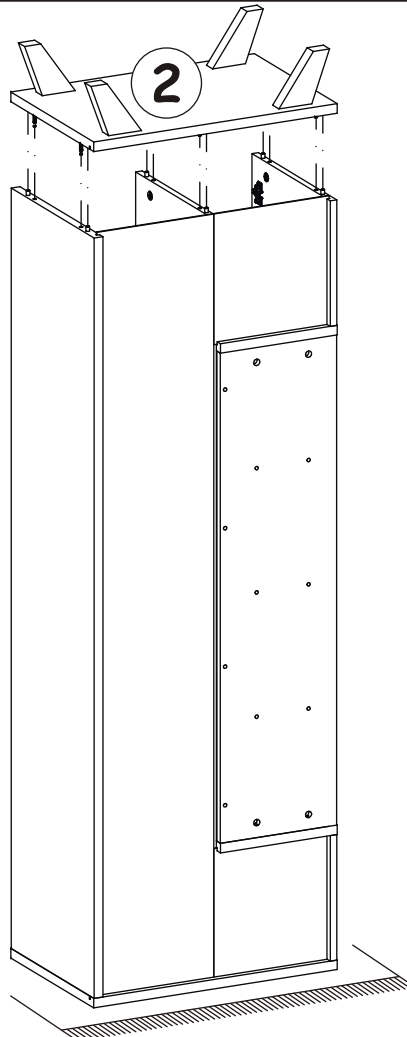
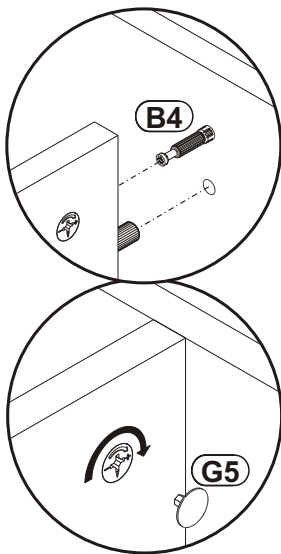

X=Y \uparrow 90°

16

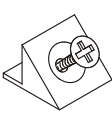
S1	
x14	

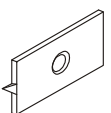
G16	
x4	

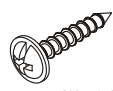
UP13	
x15	UPØ3x16

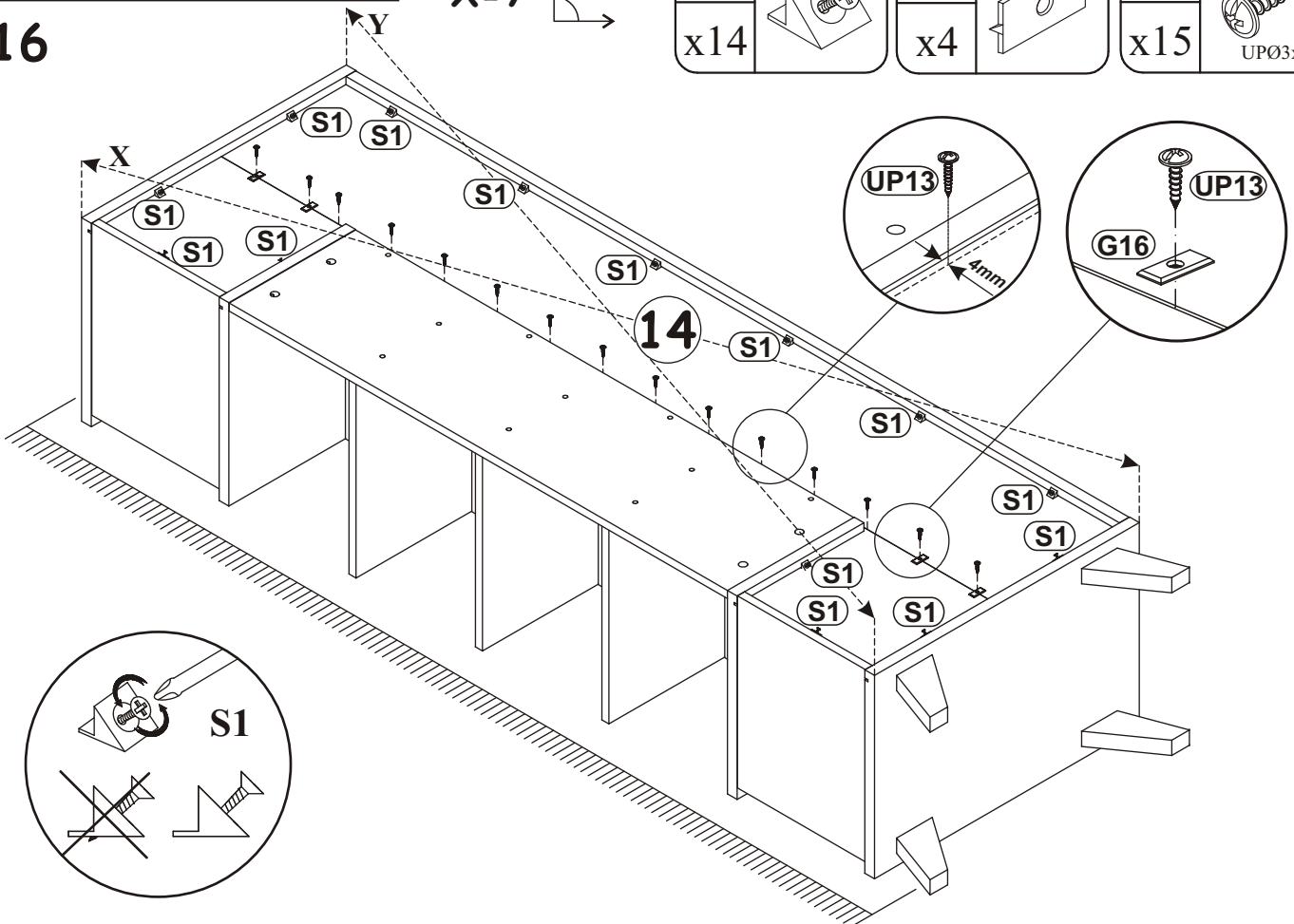

17

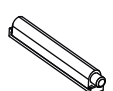
OD1	
x3	

D10	
x6	USØ3,5x13

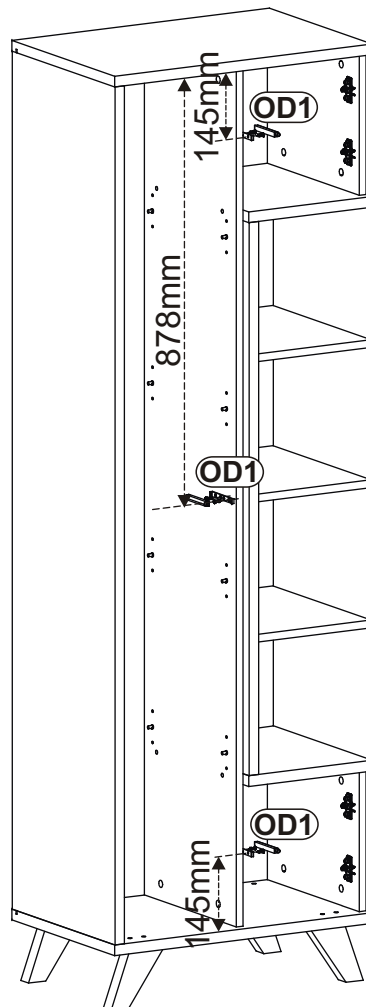
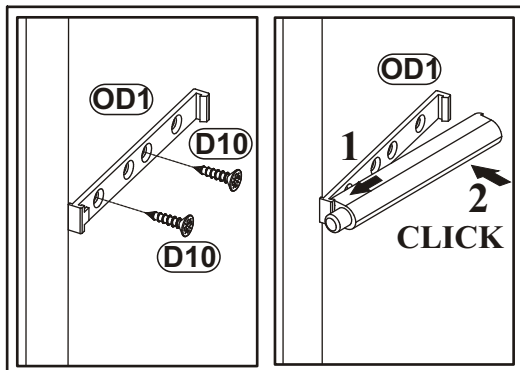

18

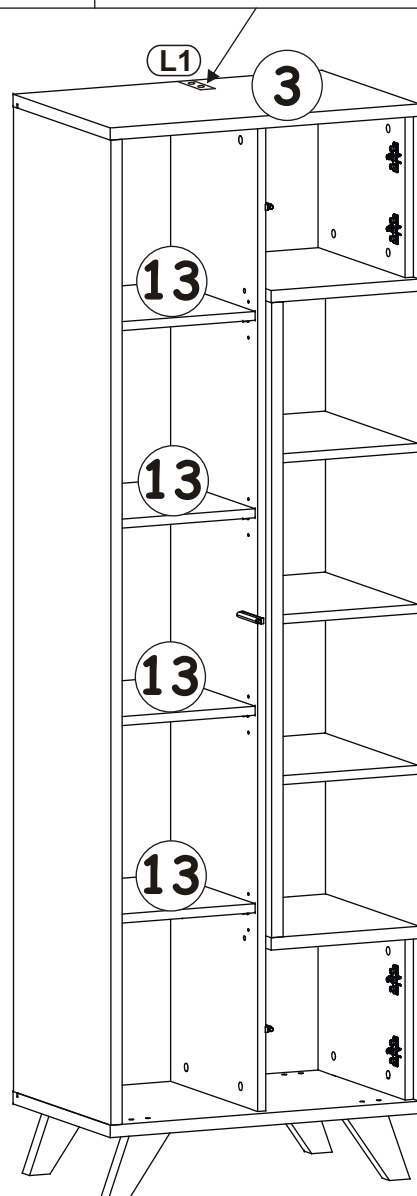
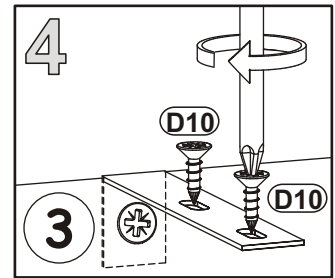
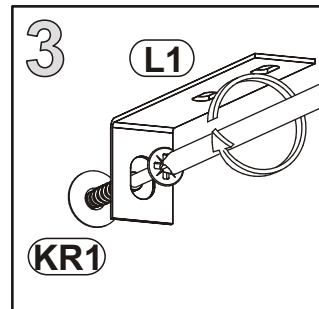
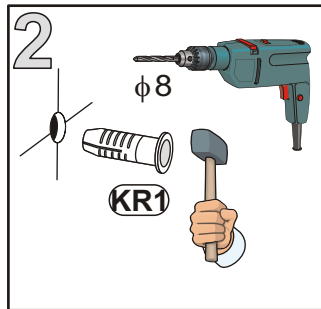
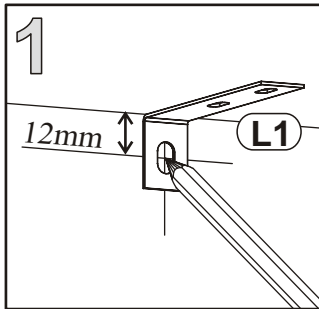
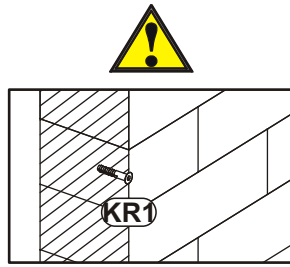
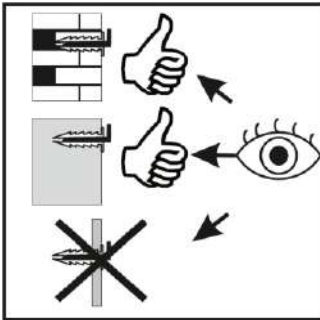
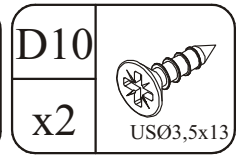
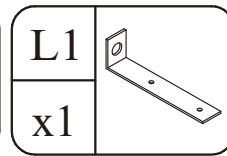
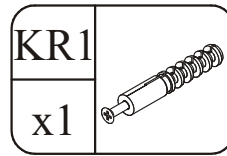

19

