

CAMINO TYP 41

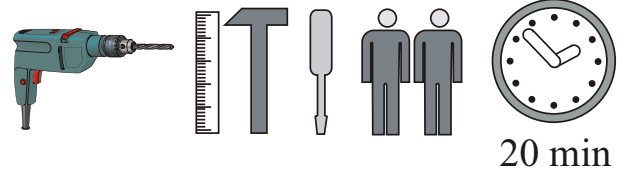
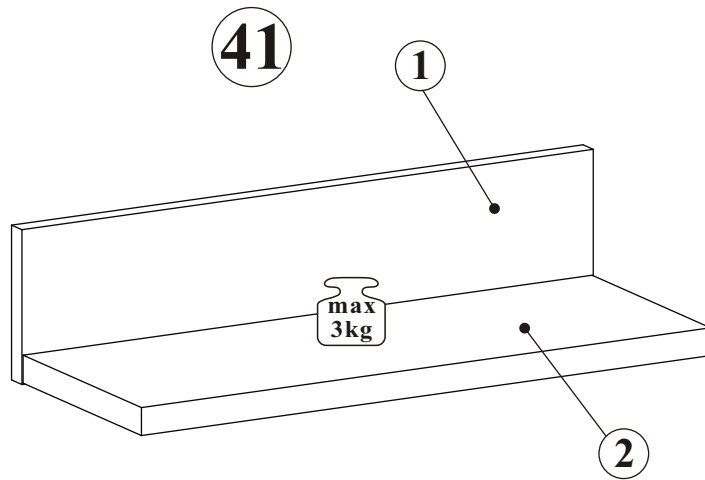
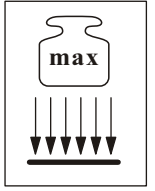
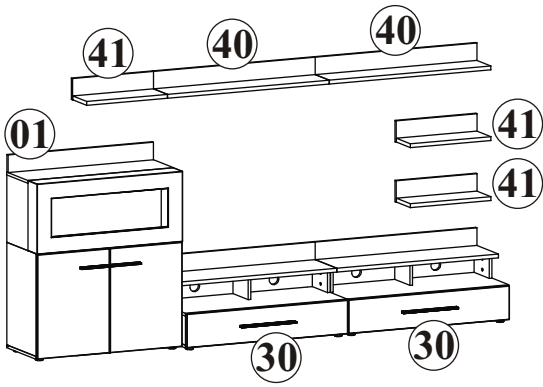

NO	Dim.		Col.-No	Qty
1	500	122	1	1
2	498	184	1	1

CAMINO TYP 41

A1 x2 Ø8x36	B11 x2 Ø7x50	G4 x2	ZM1 x2	D20 x4 ESØ6x9,5	KR2 x2
G2 x1					

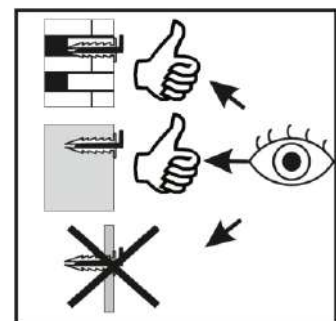
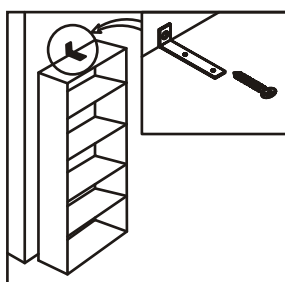
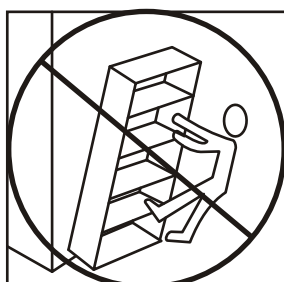
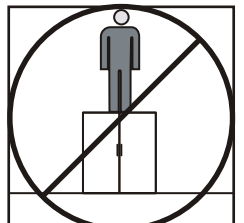
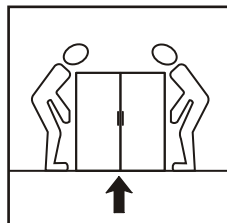
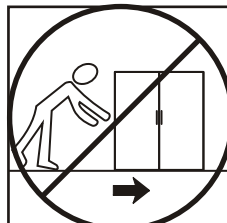
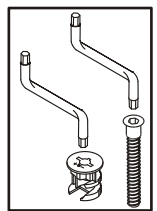
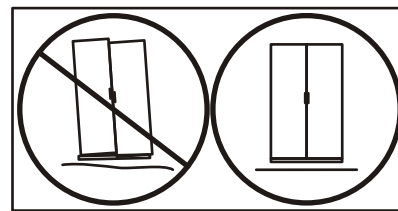
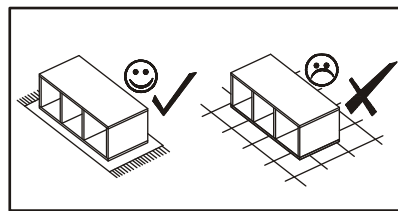
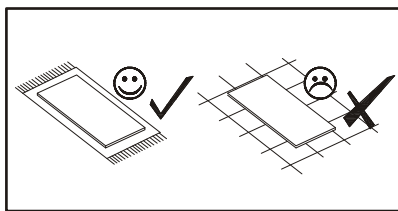
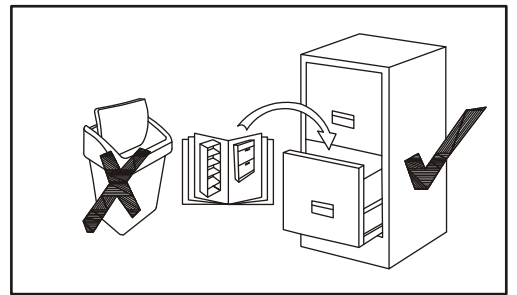
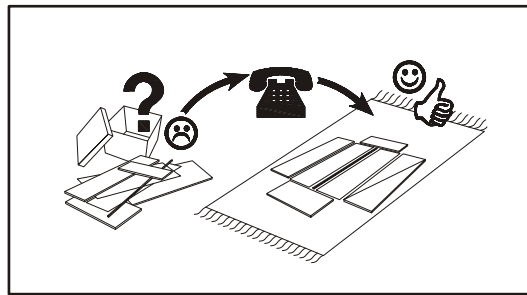
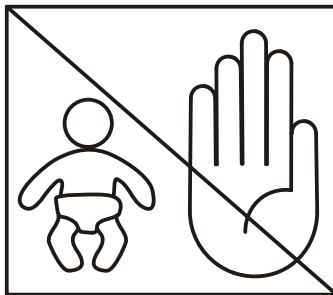
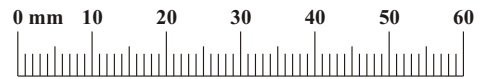

CAMINO TYP 41

1

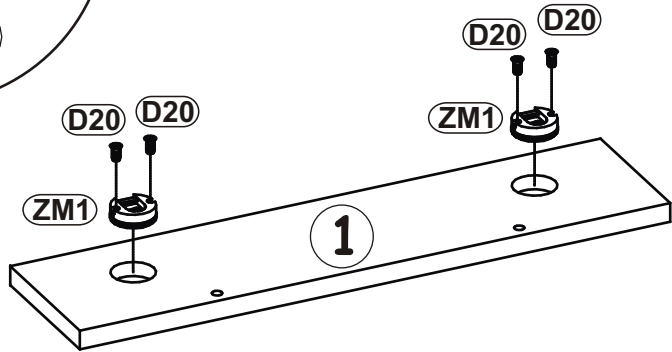
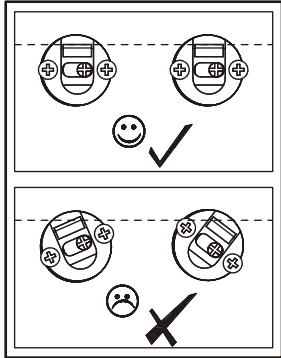
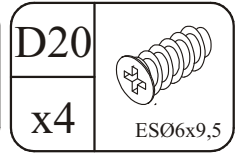
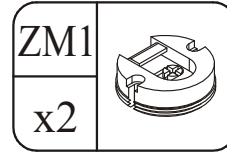
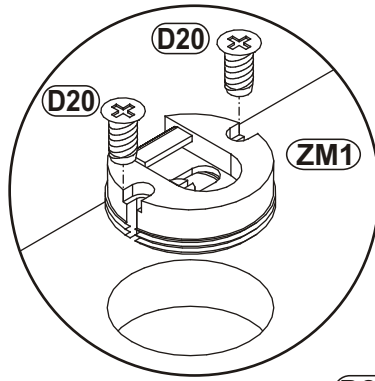

2

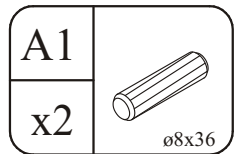
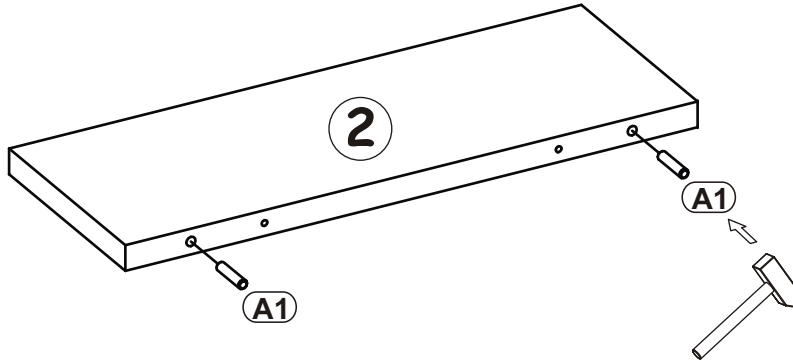
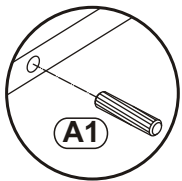

3

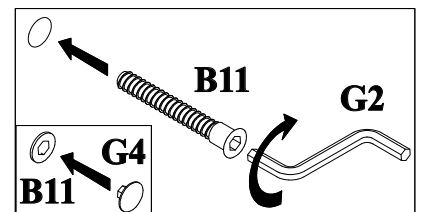
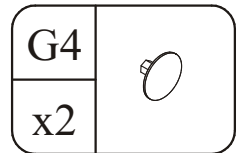
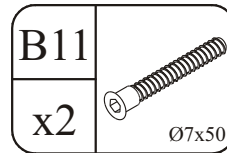
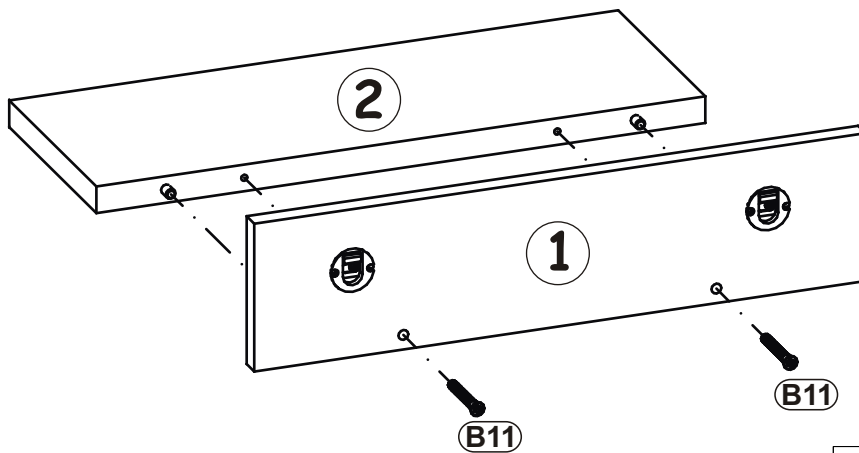

4

