

LEAVE TYP 70

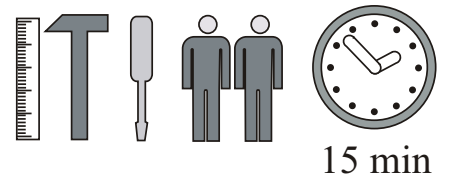
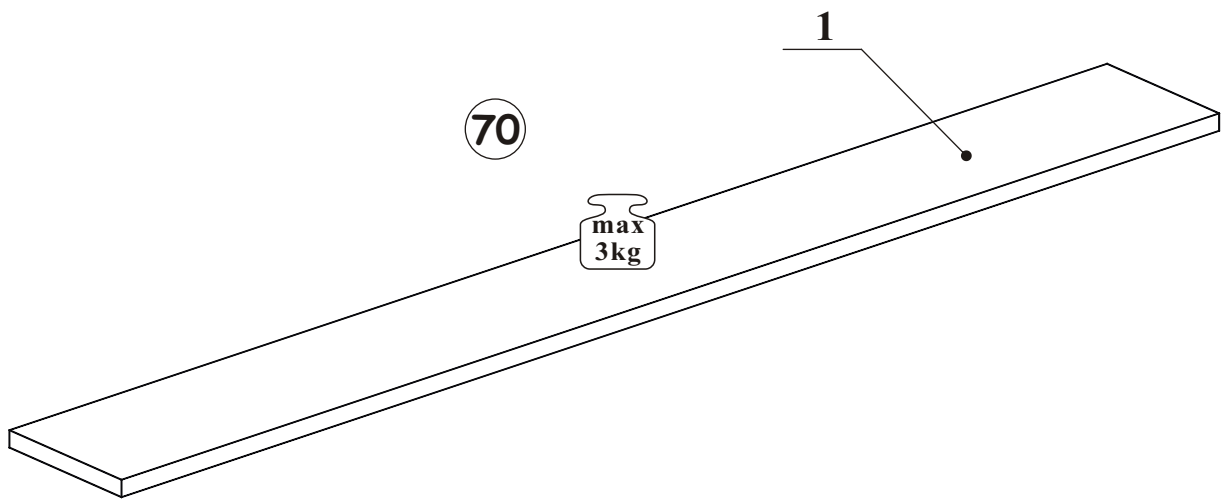
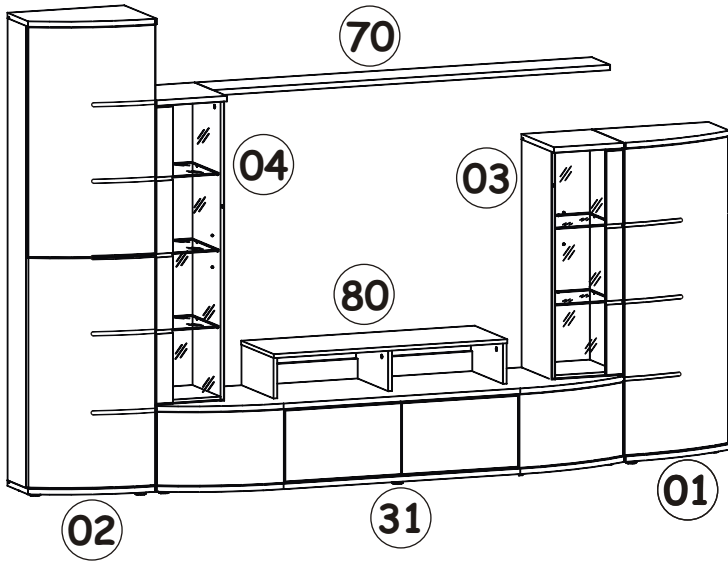

15 min

NO	Dim.	Col.-No	Qty
1	1701 200	1	1

LEAVE TYP 70

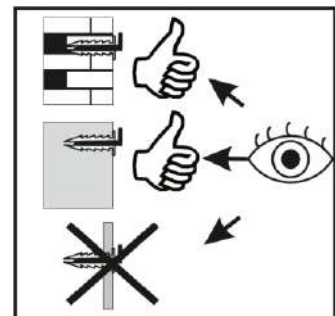
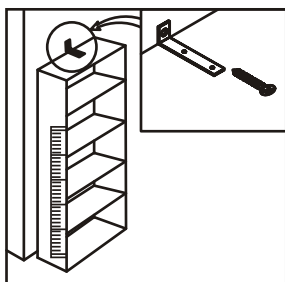
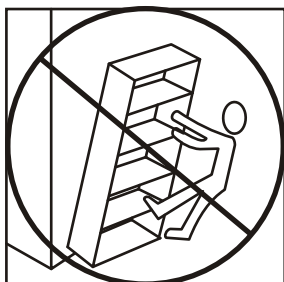
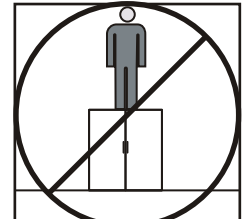
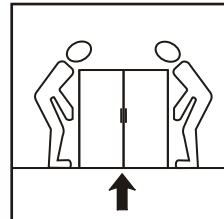
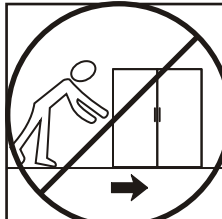
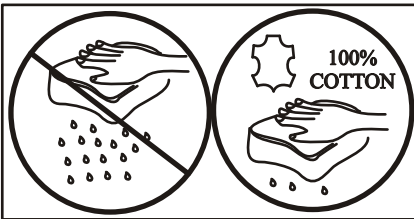
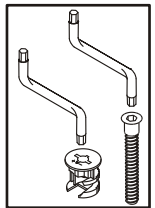
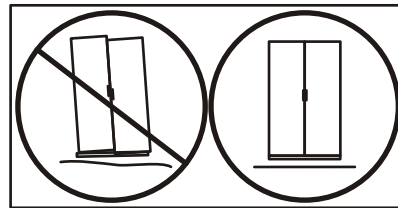
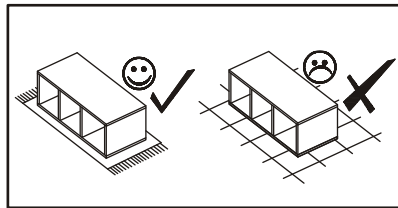
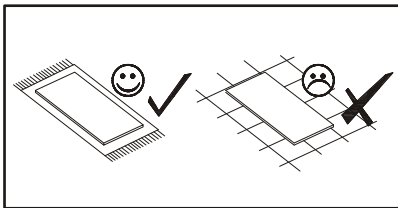
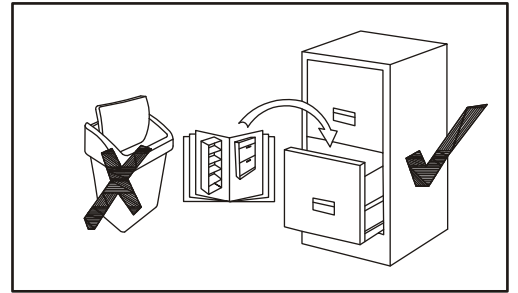
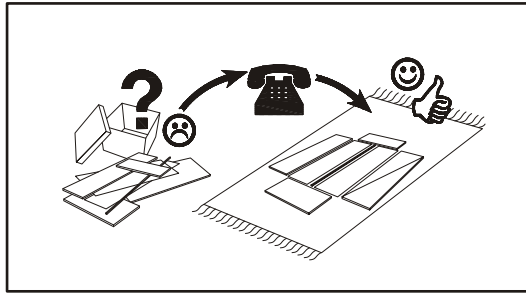
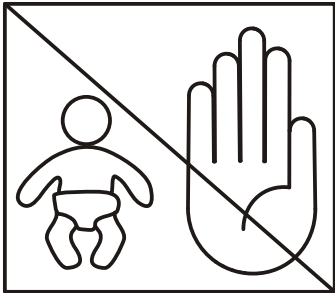
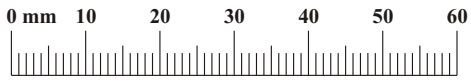
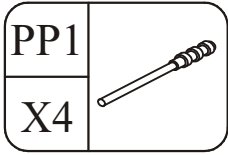

1

