

LEAVE TYP 02

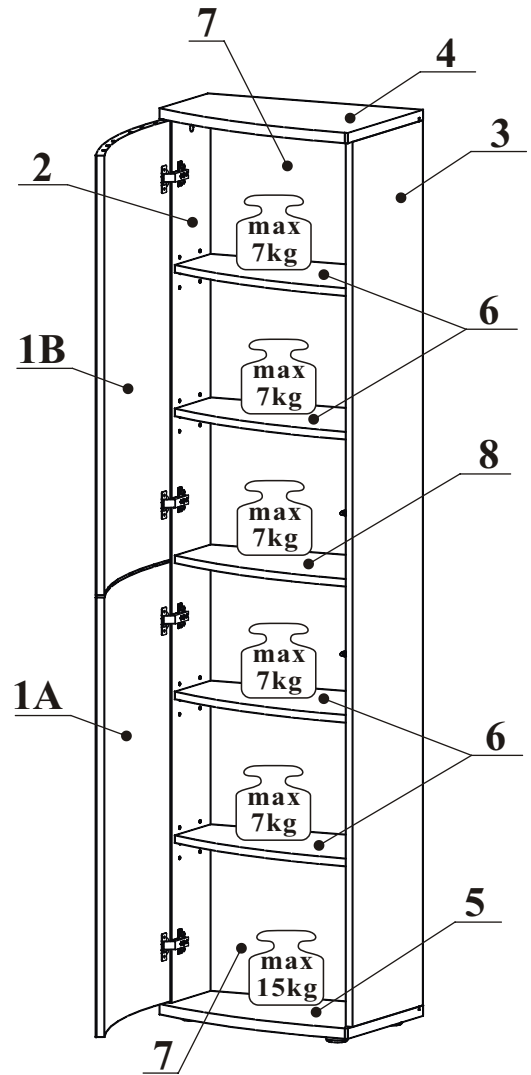

NO	Dim.		Col.-No	Qty
1A	504	927	2	1
1B	504	927	2	1
2	1867	203	1	1
3	1867	330	1	1
4	501	353	1	1
5	501	353	1	1
6	468	295	1	4
7	939	480	2	2
8	468	295	1	1

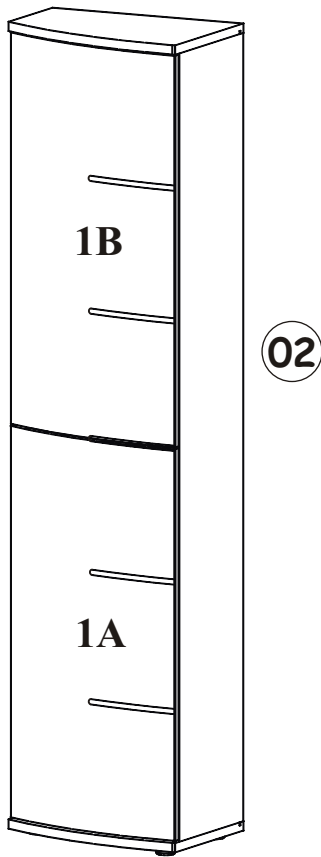
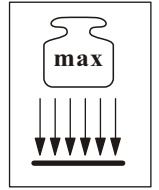
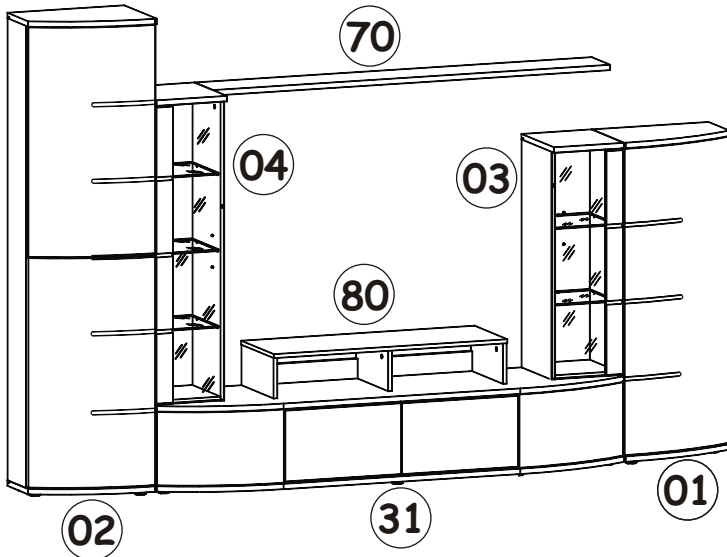
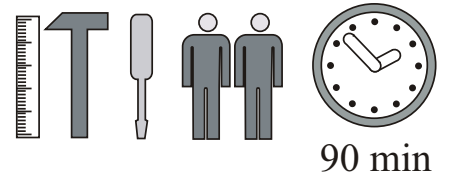

LEAVE TYP 02

A1 X12 ø8x36	B4 X6	B5 X6 ø15x12	G5 X6	B11 X3 Ø7x50	G4 X3
E21 X4 Ø35 H=0	E2 X4 H=0	D10 X14 USØ3,5x13	T2 X2 D10	S1 X16	G7 X16
I11 X4	D11 X4 USØ3,5x25	G16 X3	UP13 X3 UPØ3x16	L1 X1	KR1 X1
G2 X1					

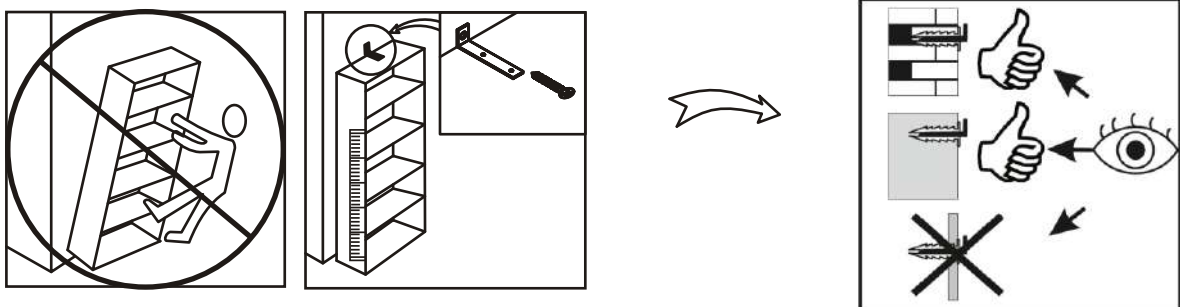
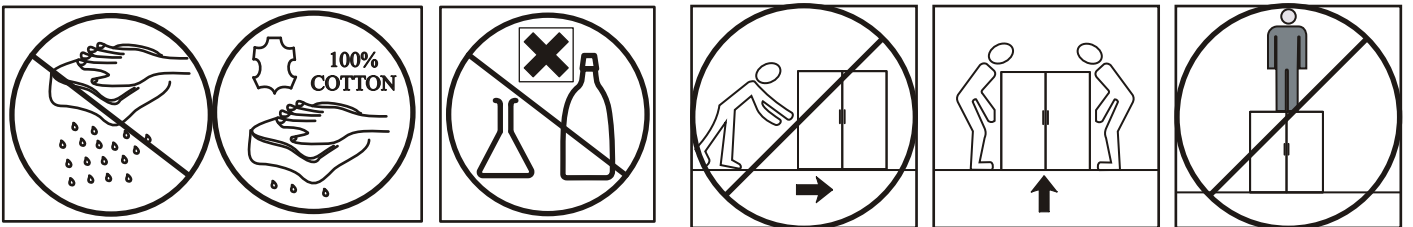
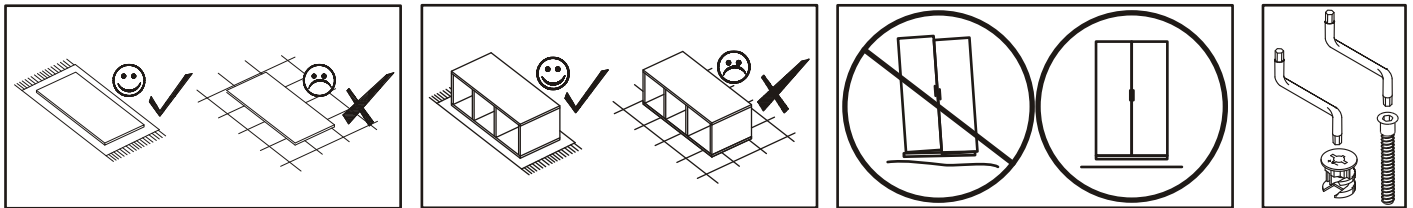
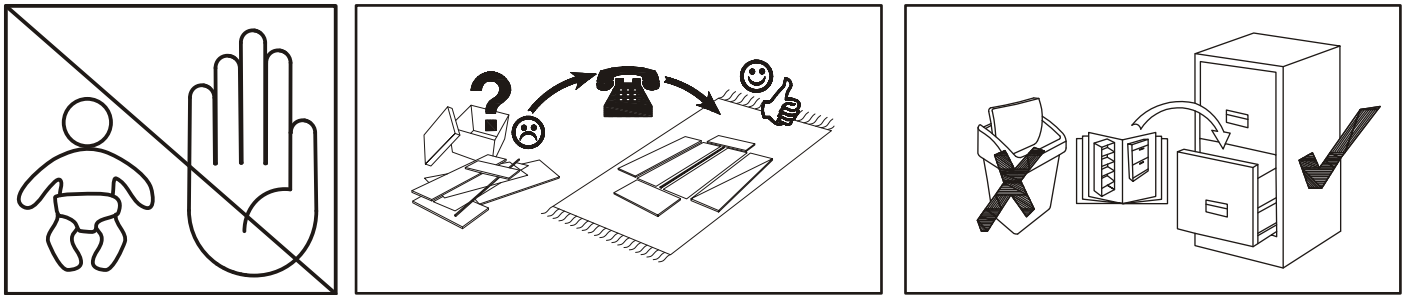
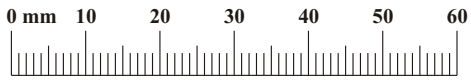

LEAVE TYP 02

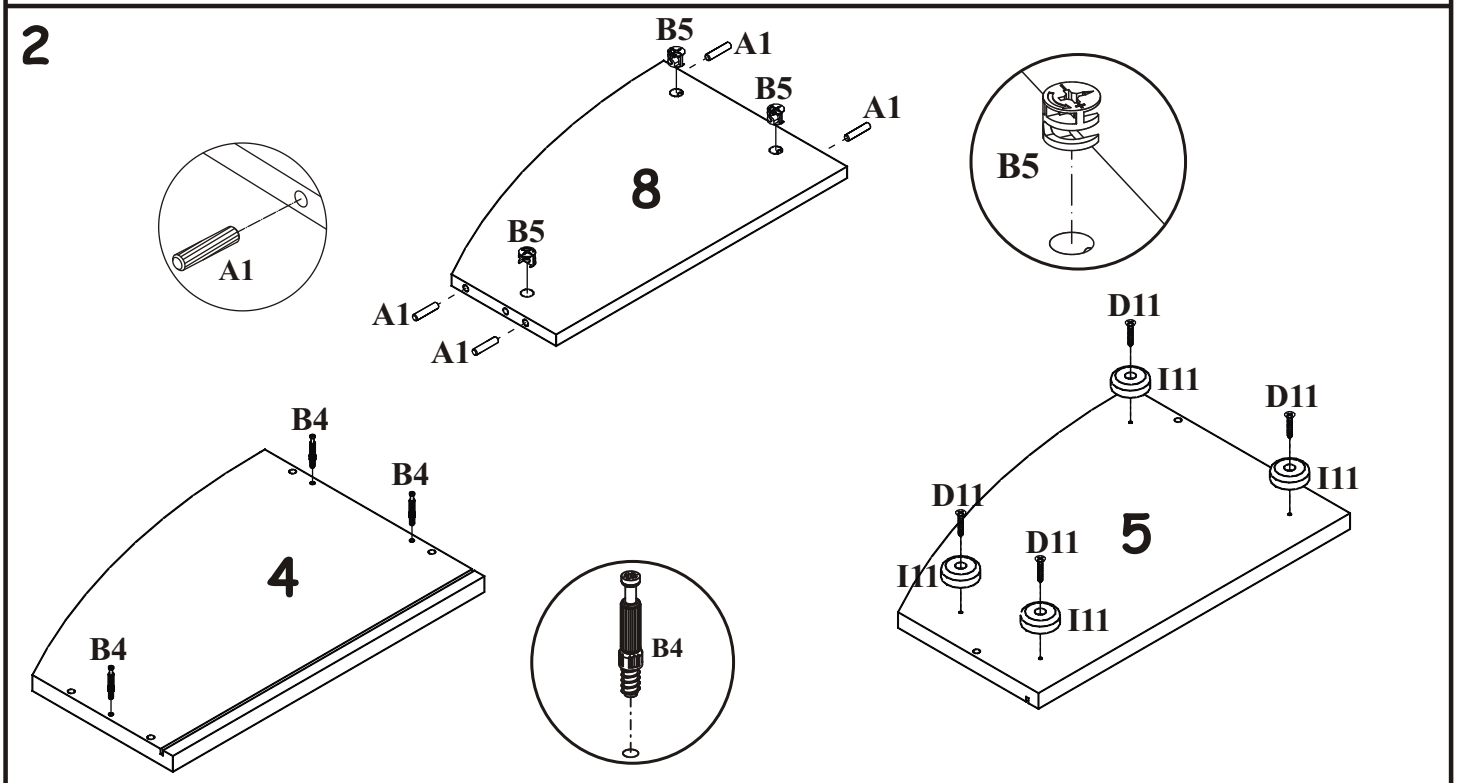
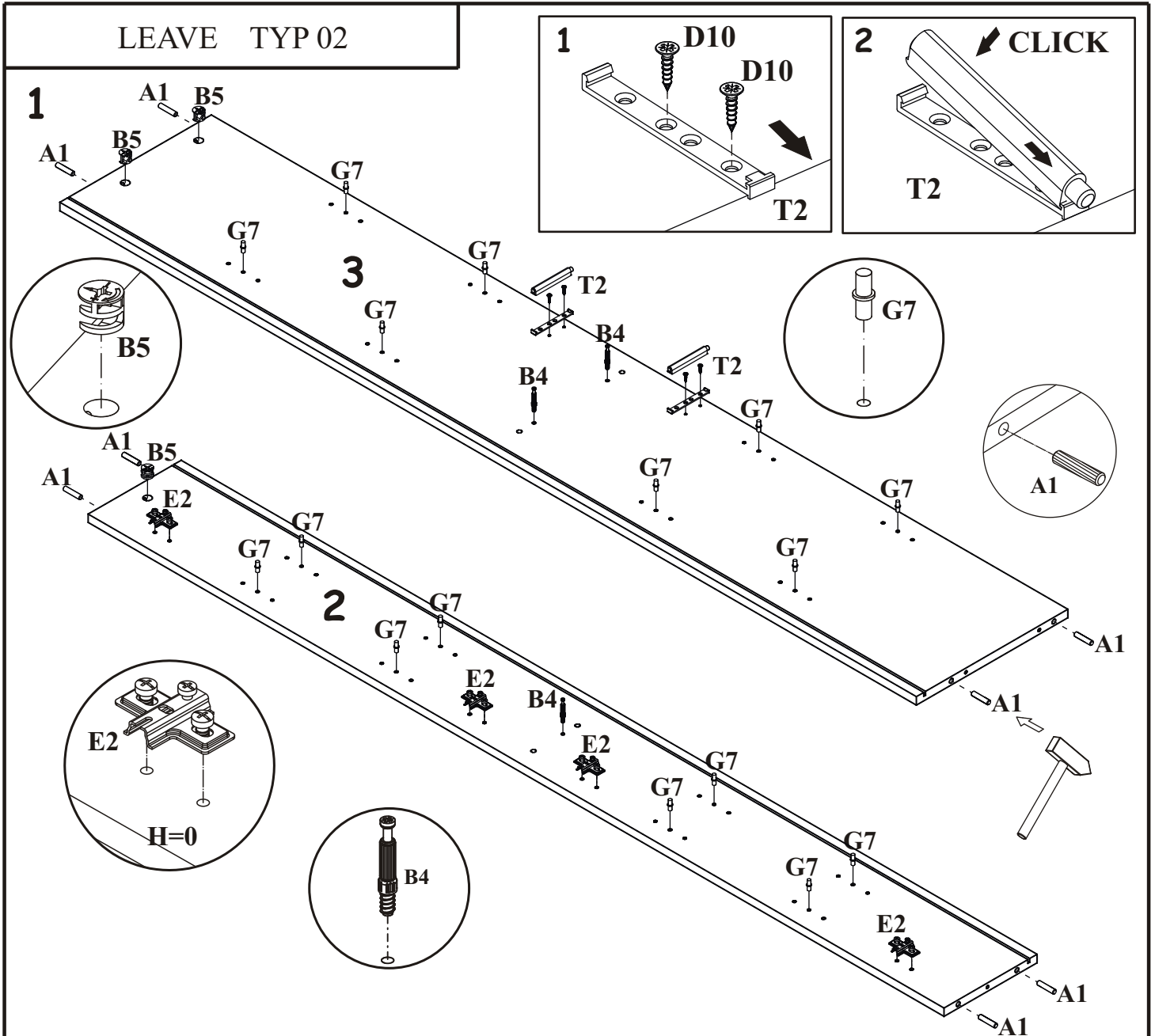

LEAVE TYP 02

3

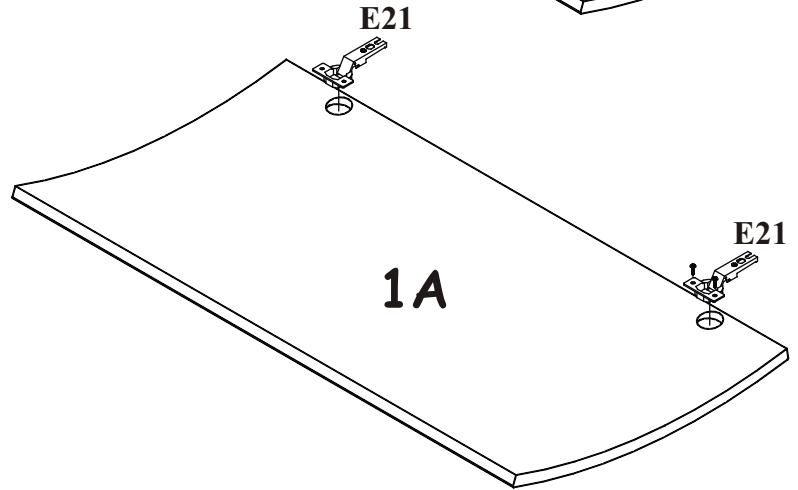
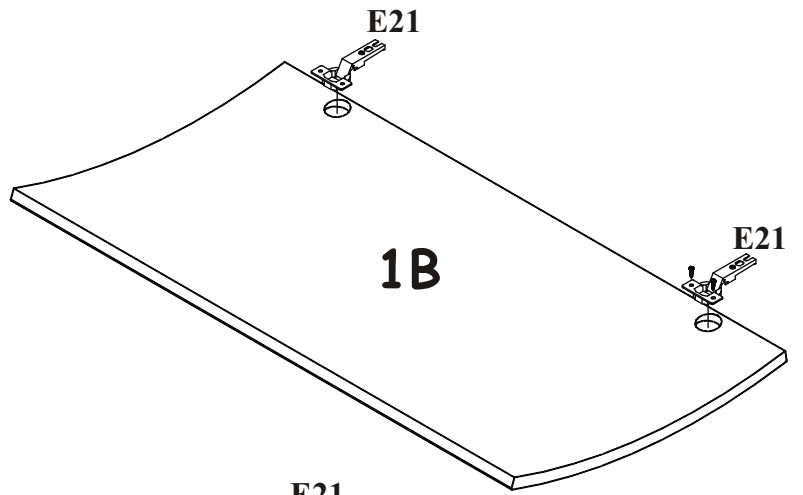
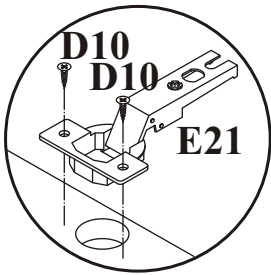
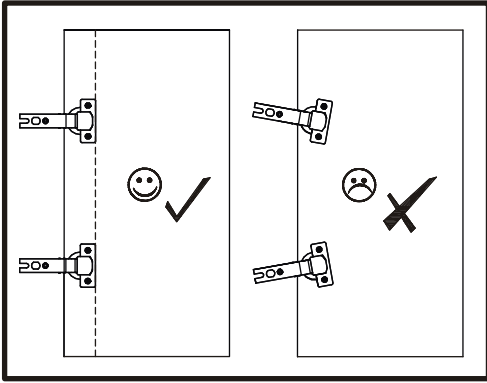

4

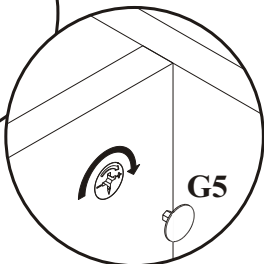
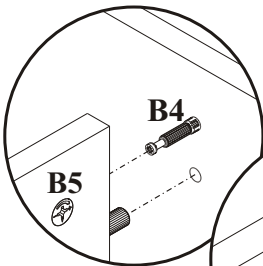
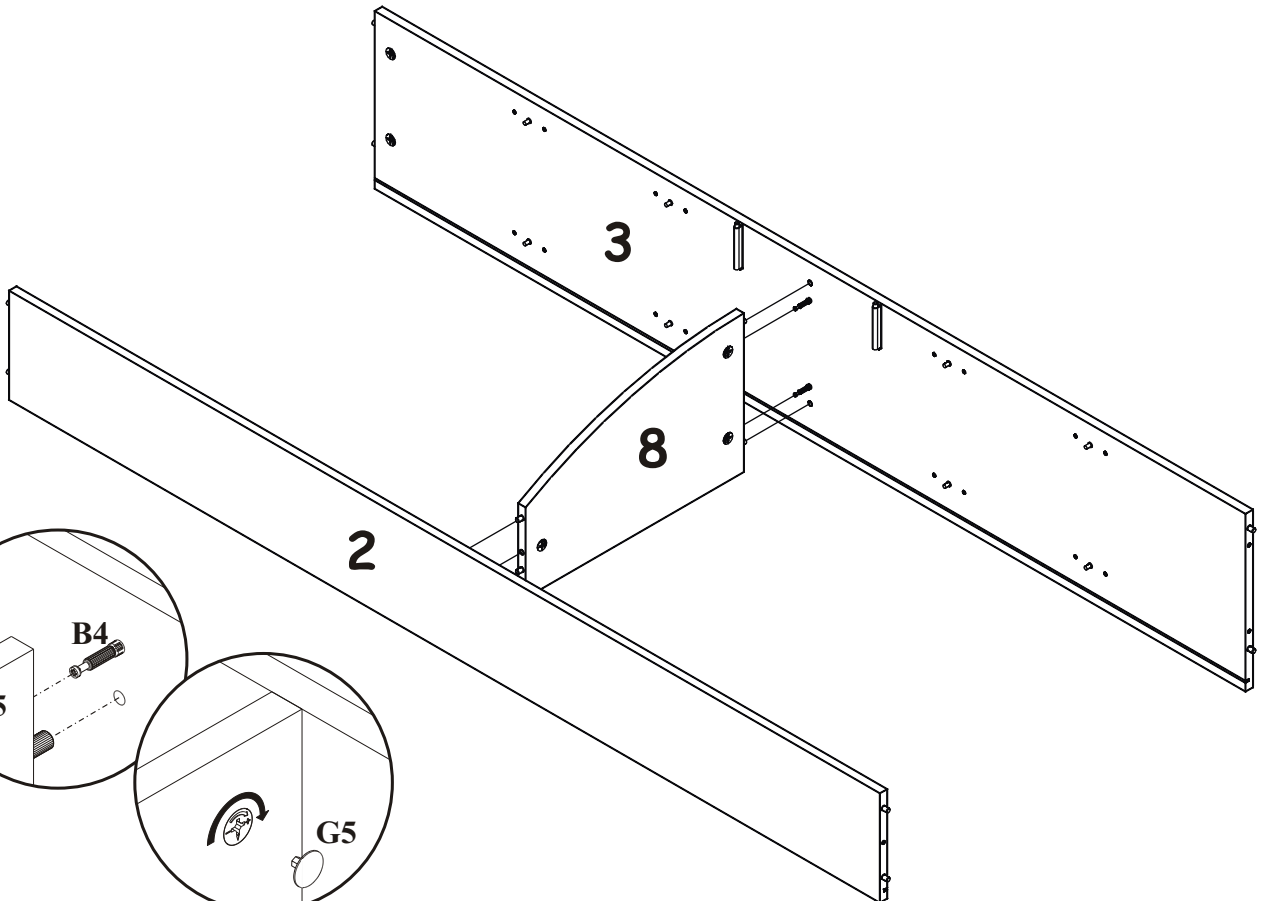

LEAVE TYP 02

5

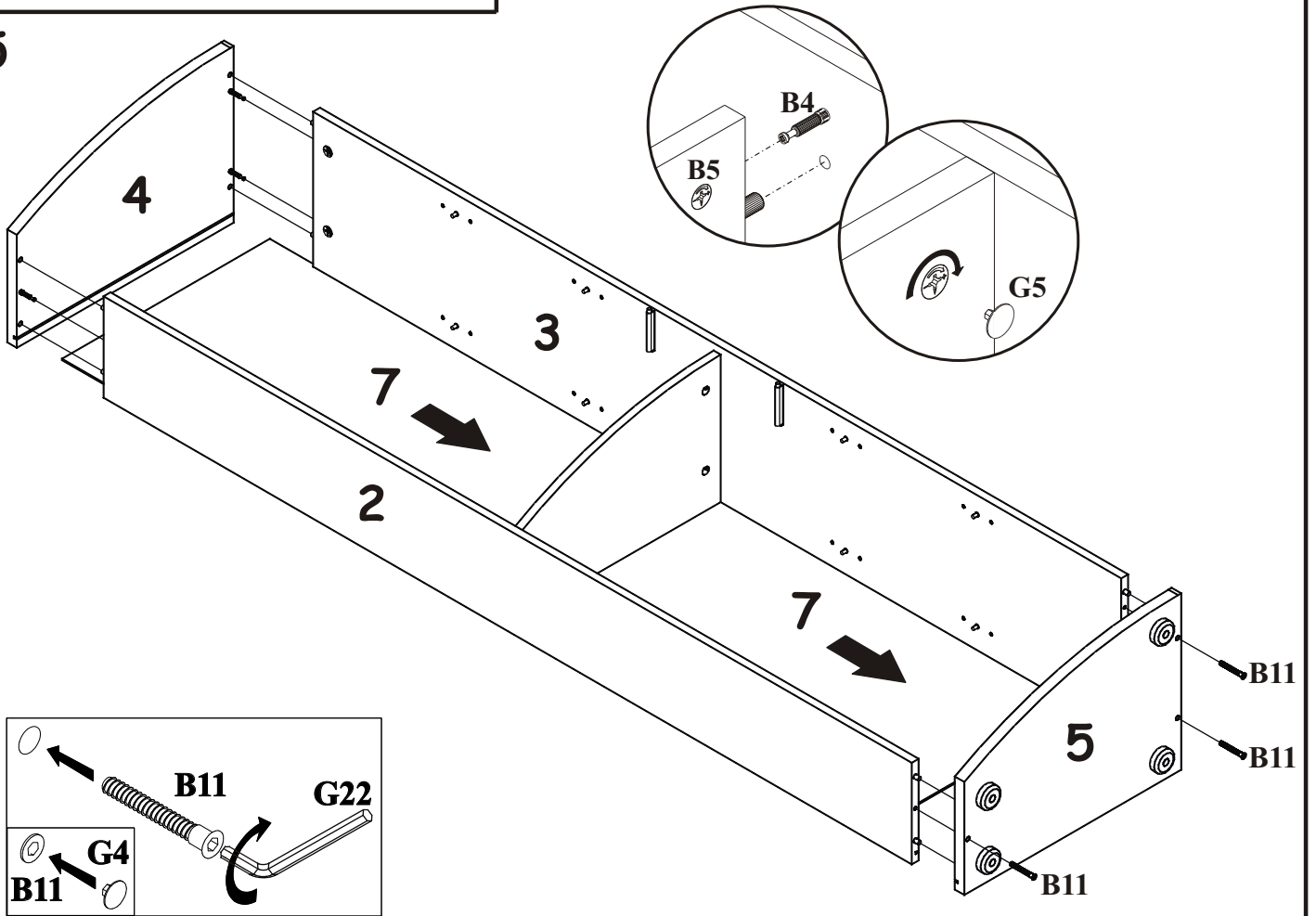

6

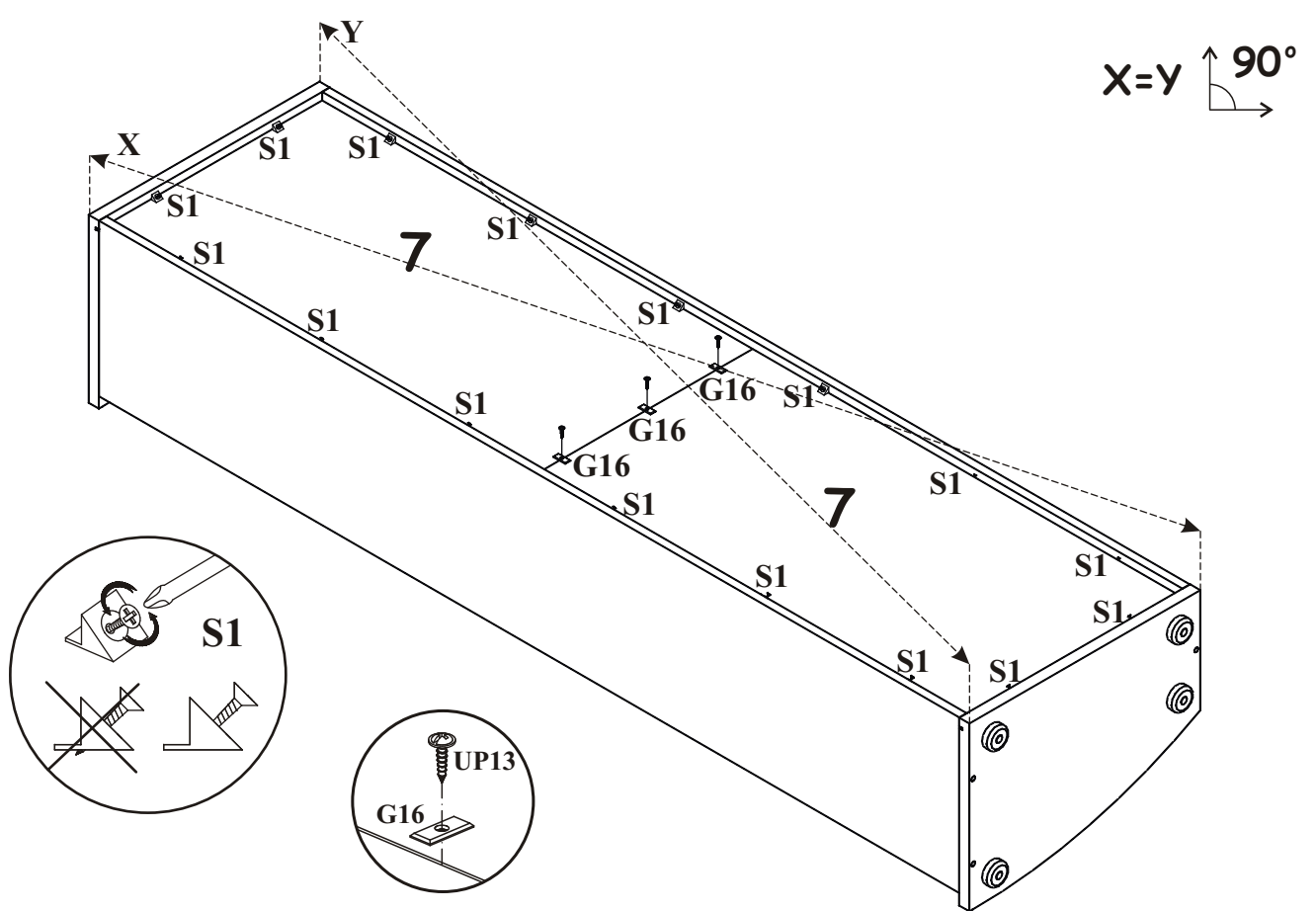

LEAVE TYP 02

5

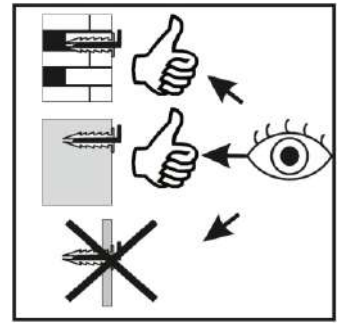
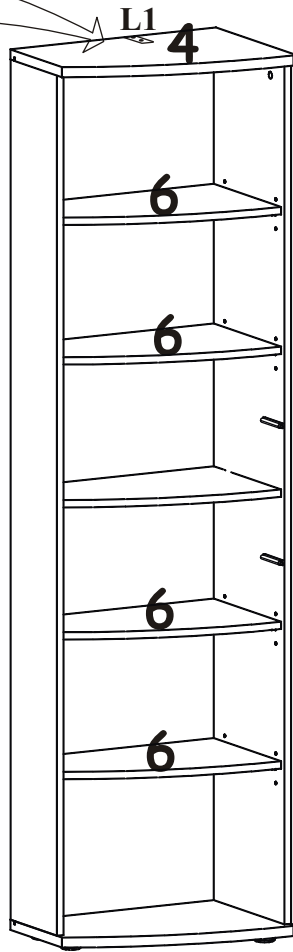
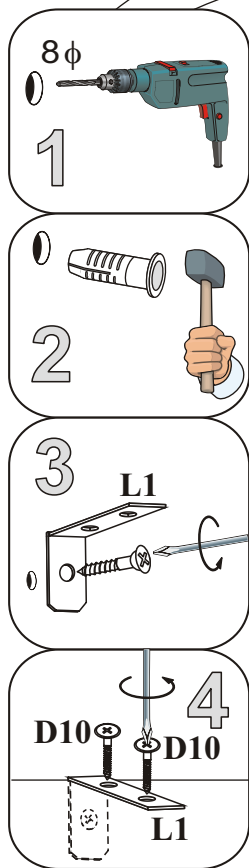

6

