

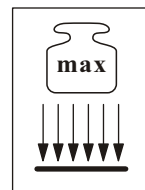

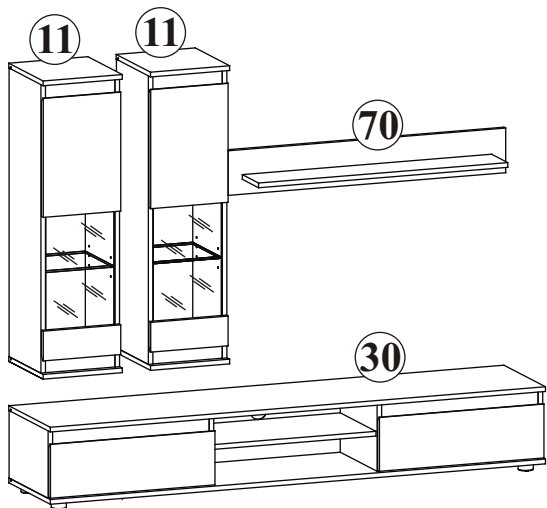

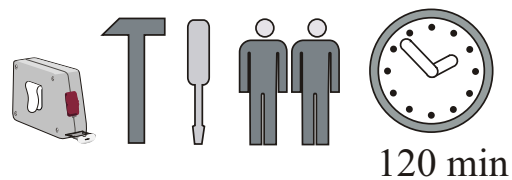

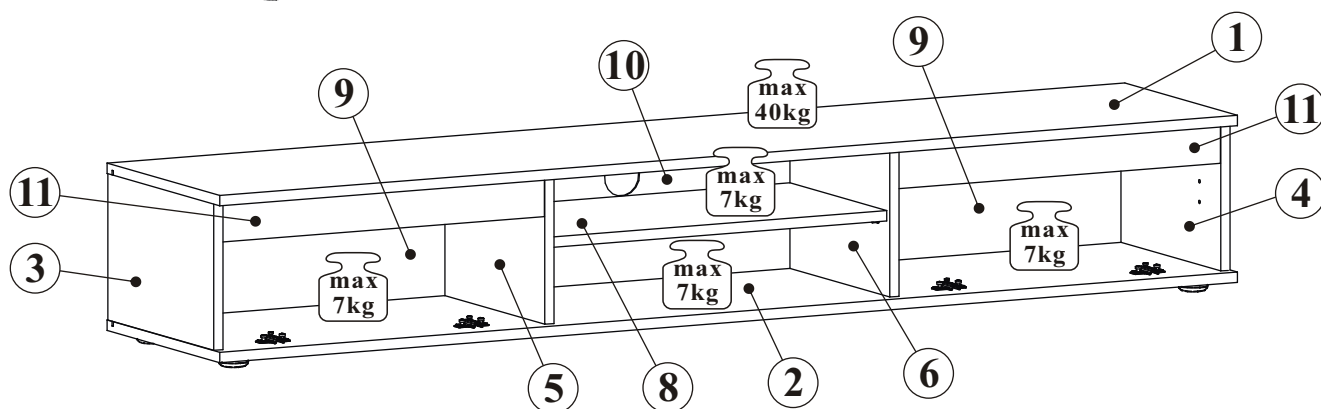

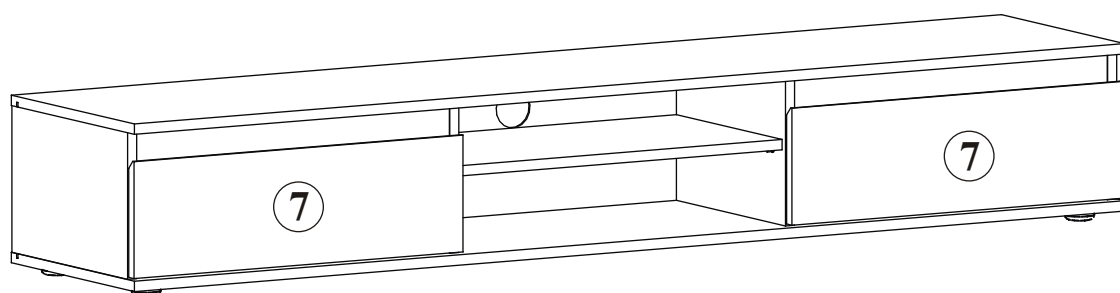

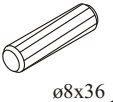
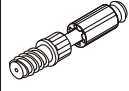

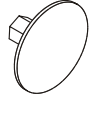
# MODO 29\_MD TYP 30

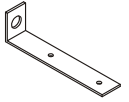
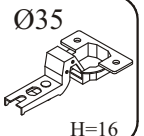
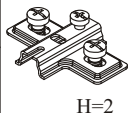

30

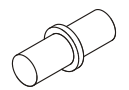

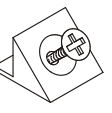
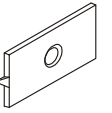
NO	Dim.		Col.-No	Qty
1	1752	370	16	2
2	1752	370	16	2
3	227	348	16	2
4	227	348	16	2
5	227	328	16	2
6	227	328	16	2
7	582	180	16	2
8	578	318	16	2
9	568	238	3	2
10	592	238	3	2
11	554	60	16	2

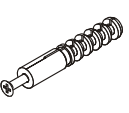

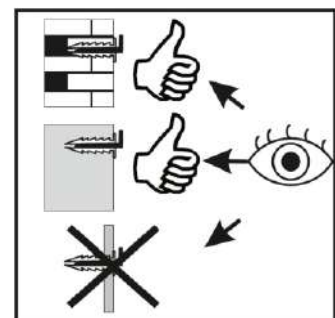
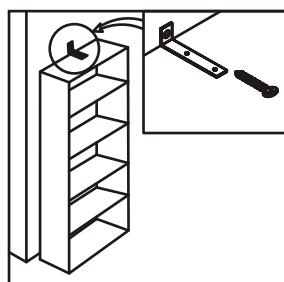
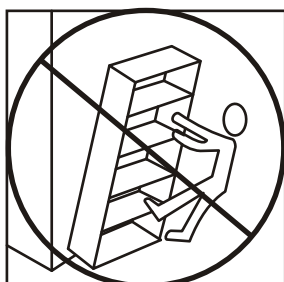
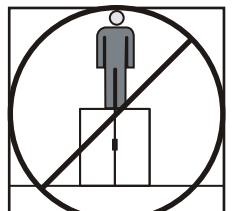
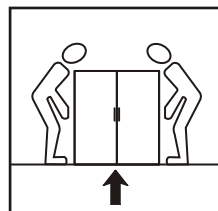
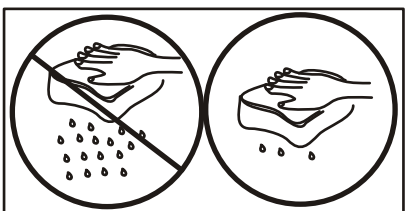
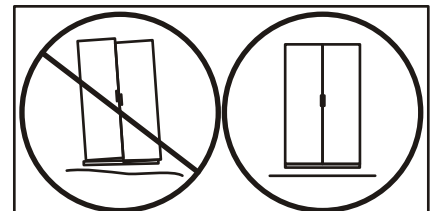
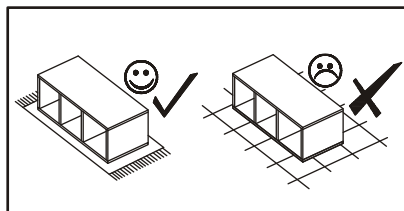
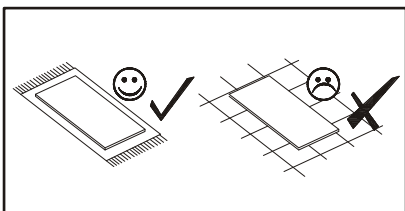
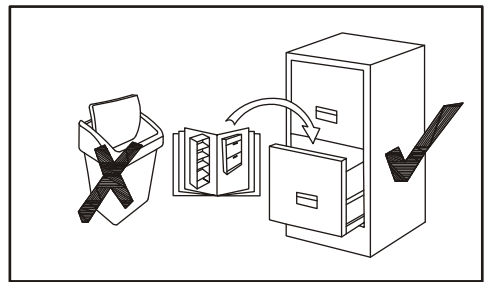
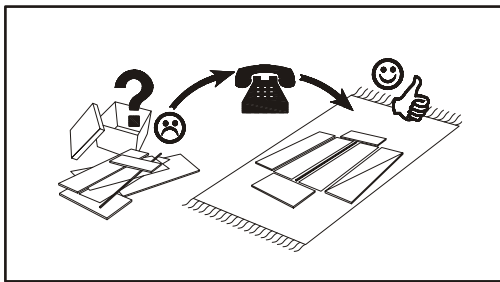
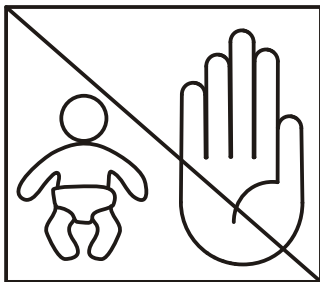
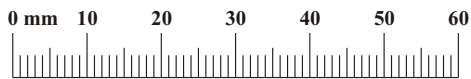
A1 x24  ø8x36	B4 x8 	B5 x8  Ø15x12	G5 x8 	B11 x8  Ø7x50	L1 x2 
E25 x4  Ø35 H=16	E4 x4  H=2	D10 x18  USØ3,5x13	G21 x2 	D7 x6  USØ3x16	G7 x4 
I11 x6  Ø50, h=25	UP15 x6  UPØ4x25	S1 x14 	G16 x4 	UP13 x4  UPØ3x16	KR1 x2 

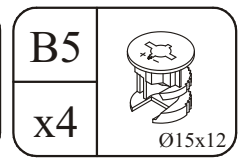
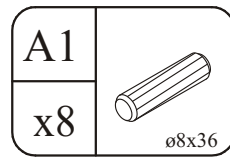

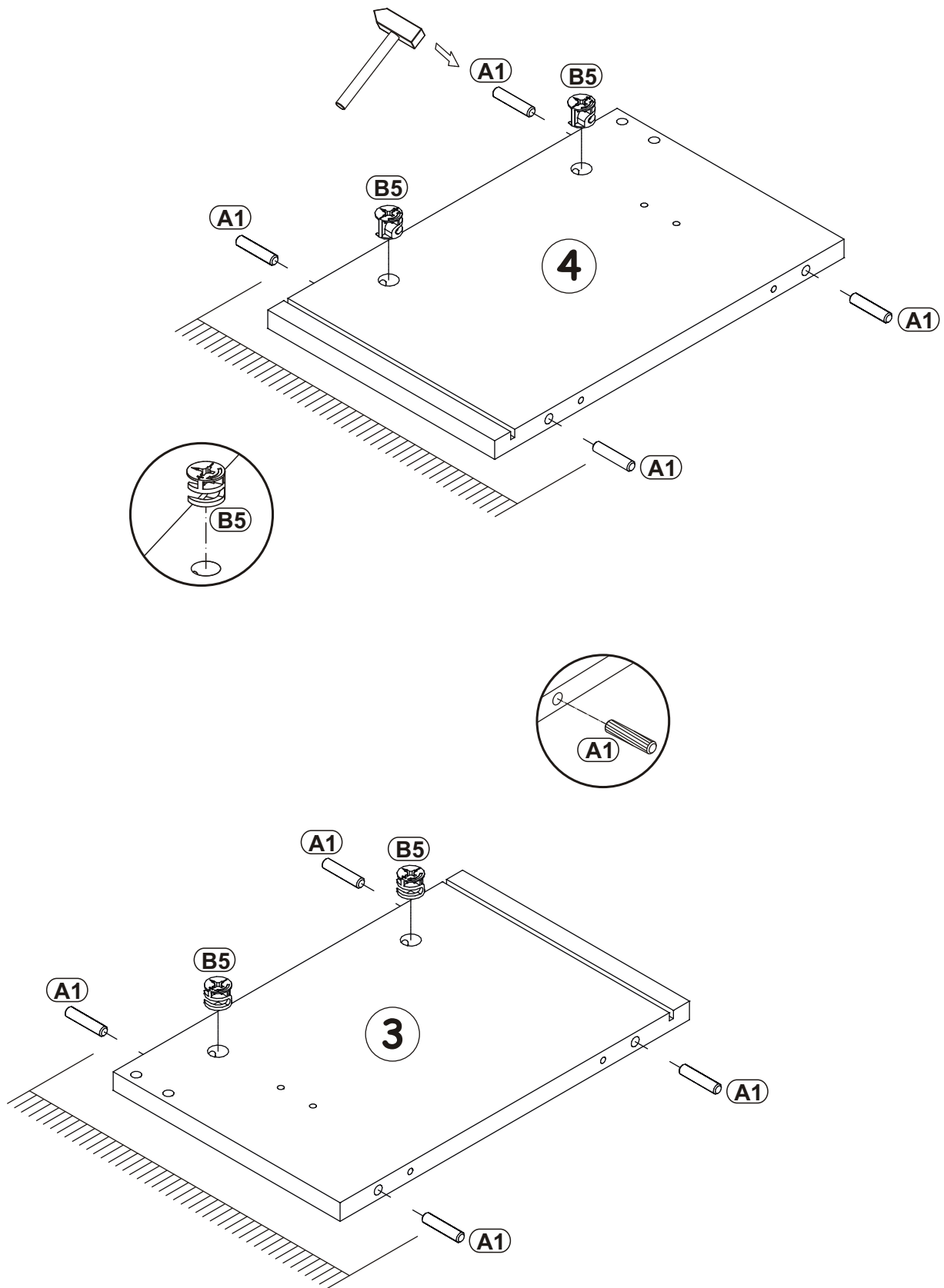

1

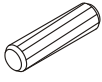

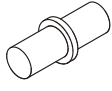
A1		B5		G7	
x8	ø8x36	x4	Ø15x12	x4	

2

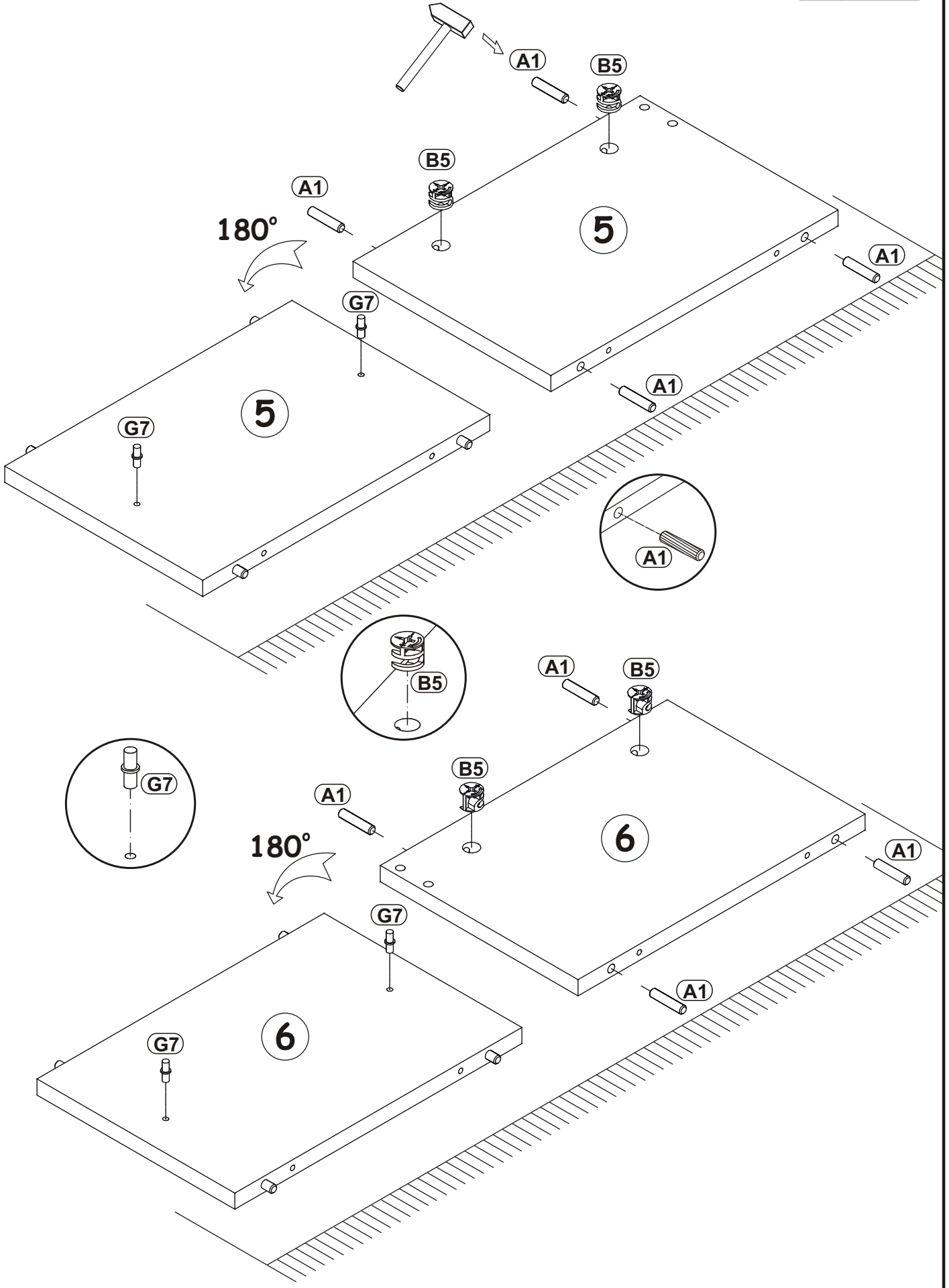

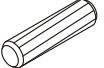

A1	
x8	ø8x36

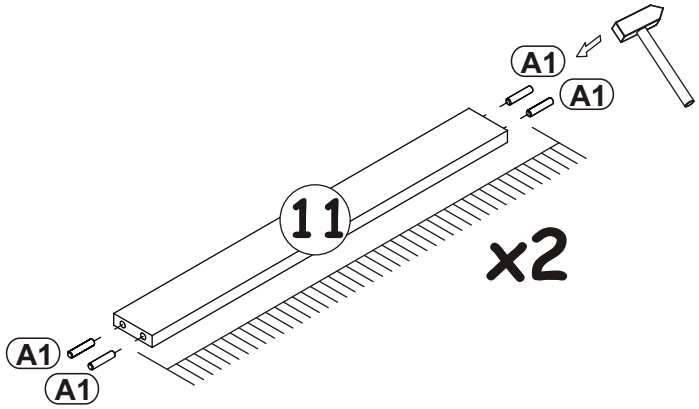
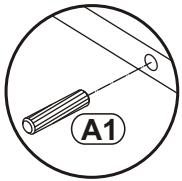
3

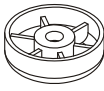

4

I11	
x6	Ø50, h=25

UP15	
x6	UPØ4x25

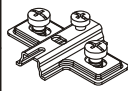
E4	
x4	H=2

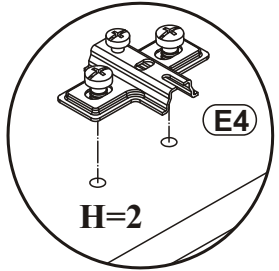
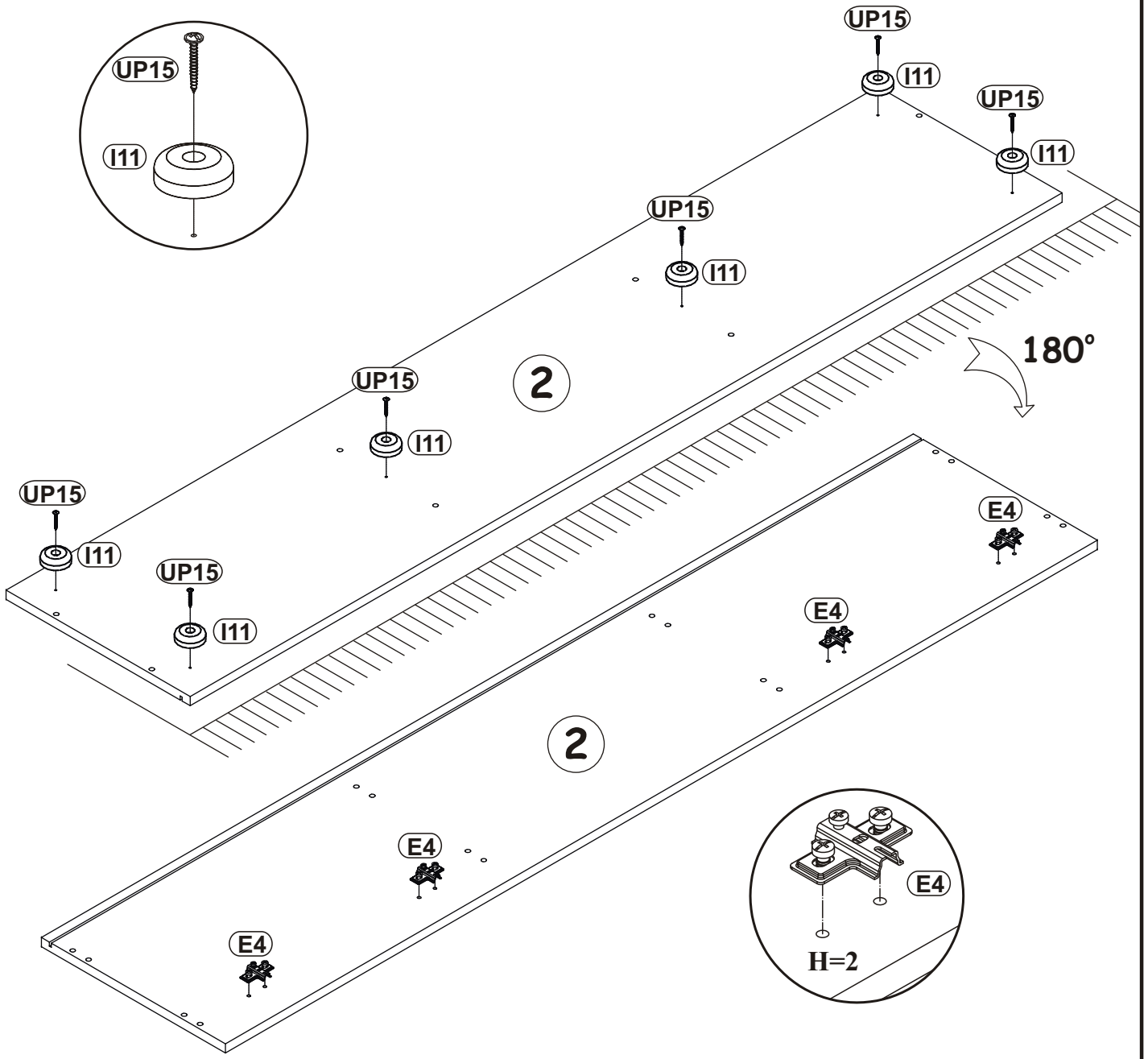
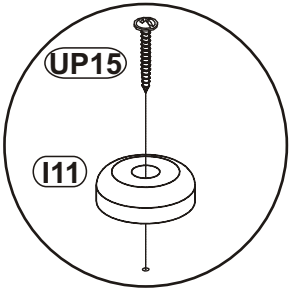

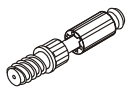

B4	
x8	

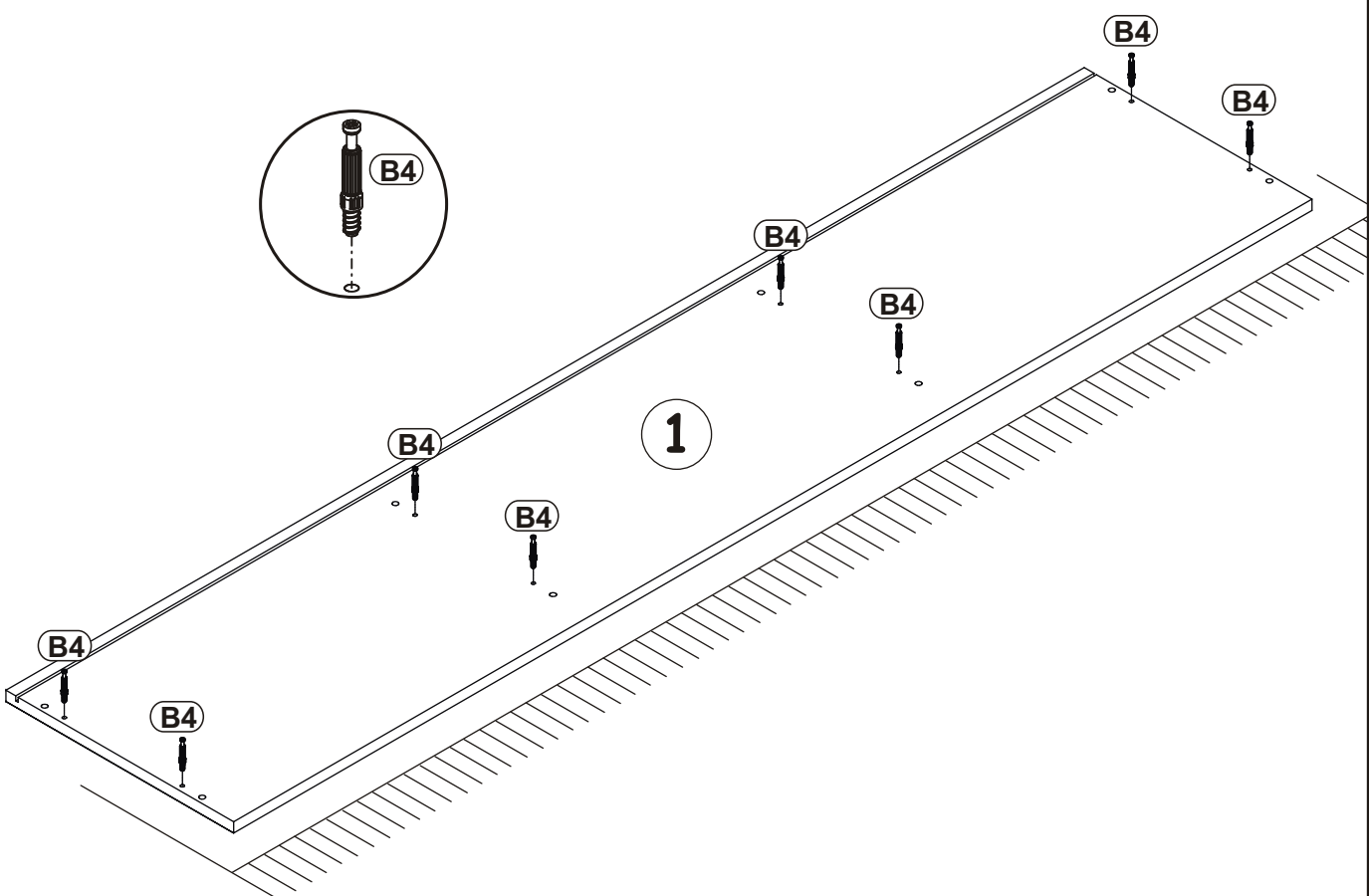
5

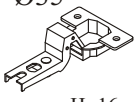

6

E25		Ø35	
x4	H=16	x8	USØ3,5x13

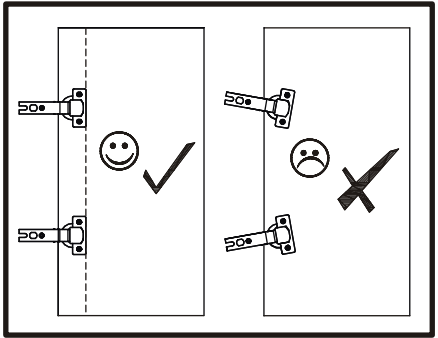
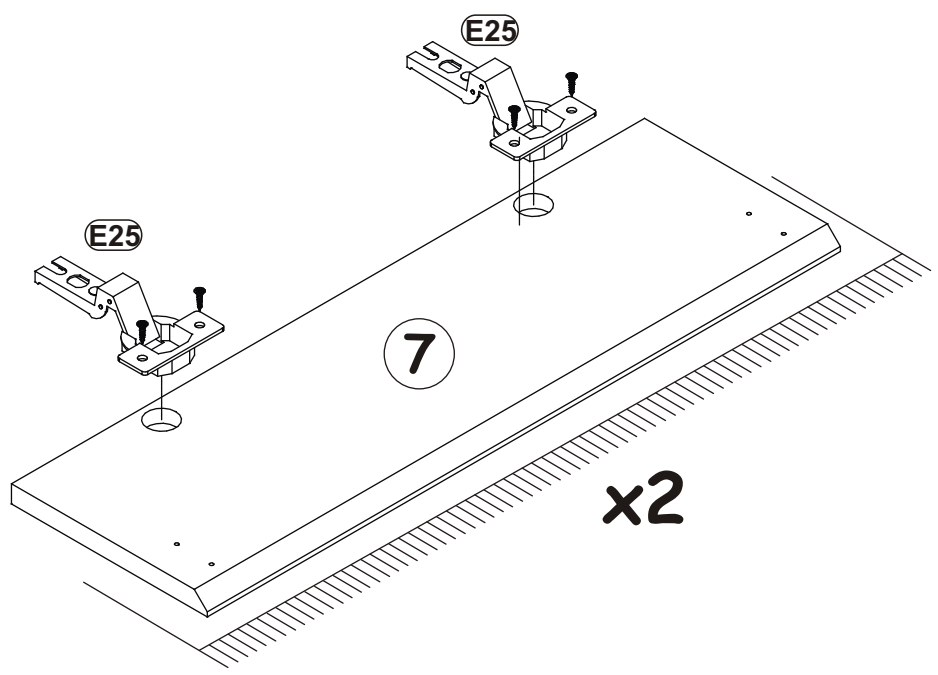
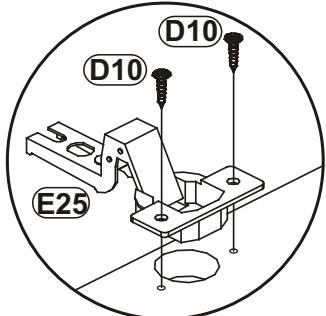

7

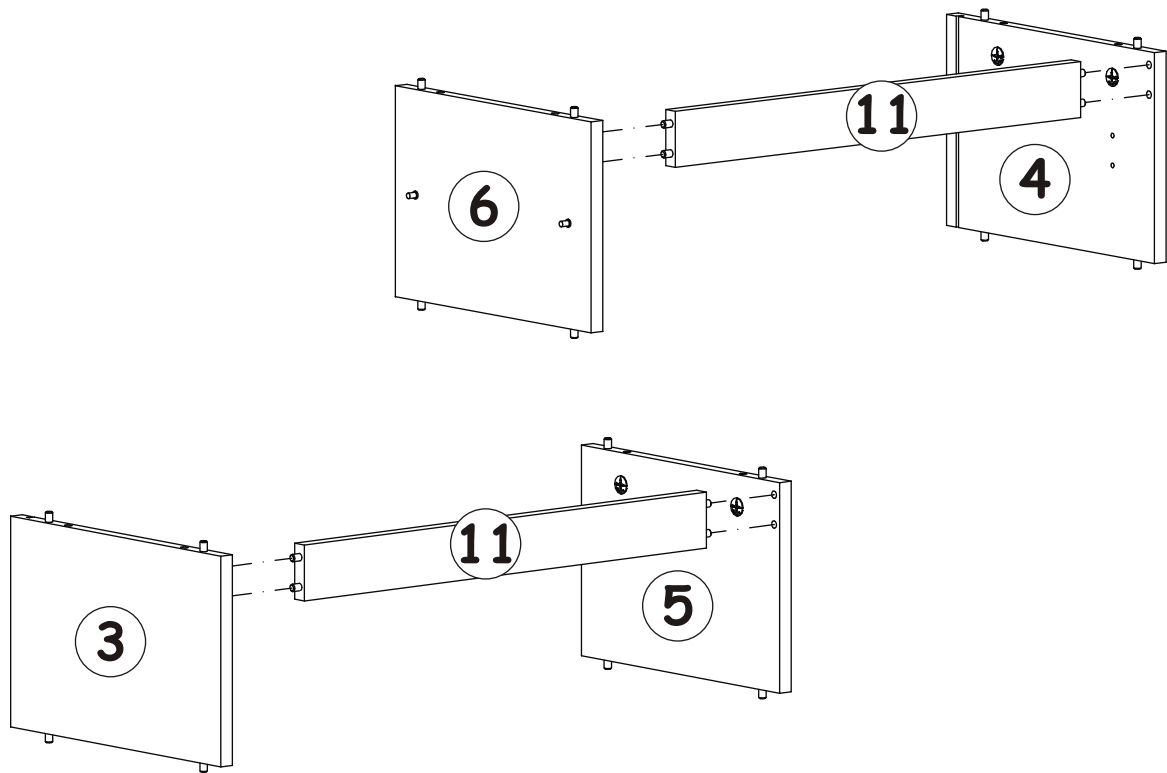

8

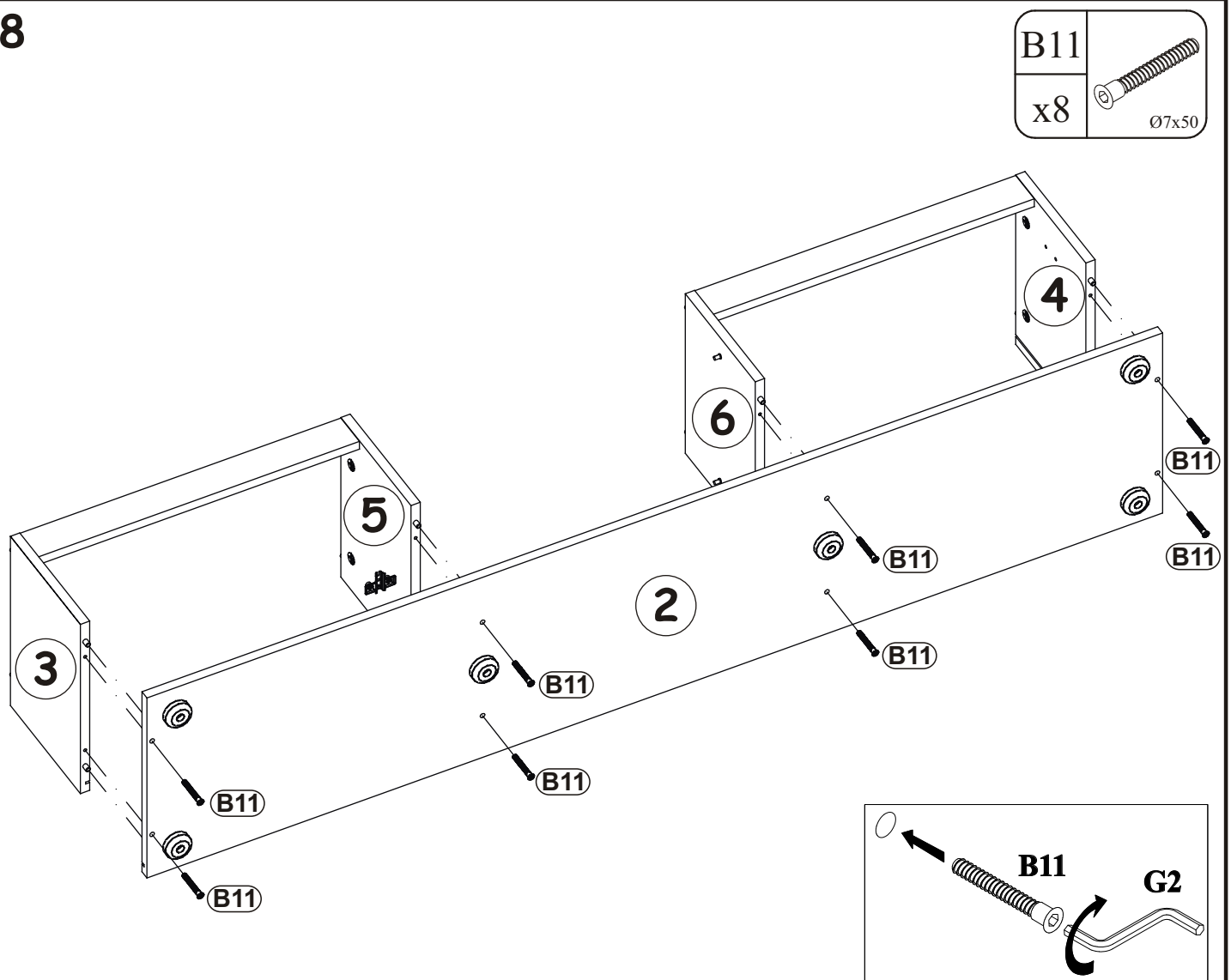

G5

x8



9

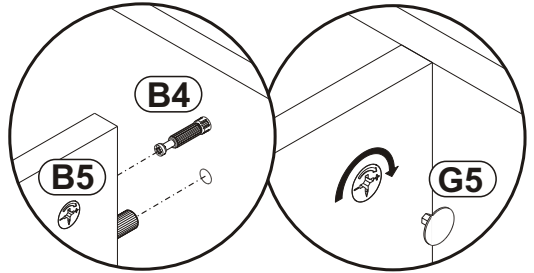
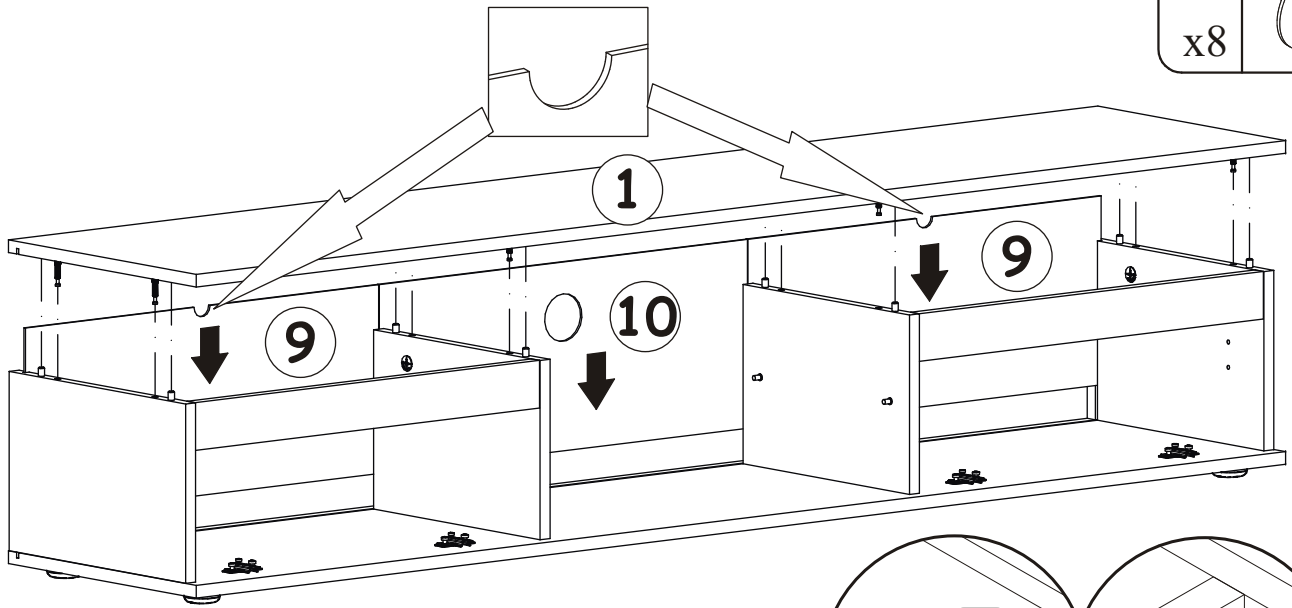

10

S1  
x14

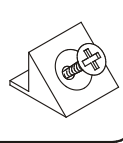

G16  
x4

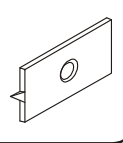

UP13  
x4



X=y 90°

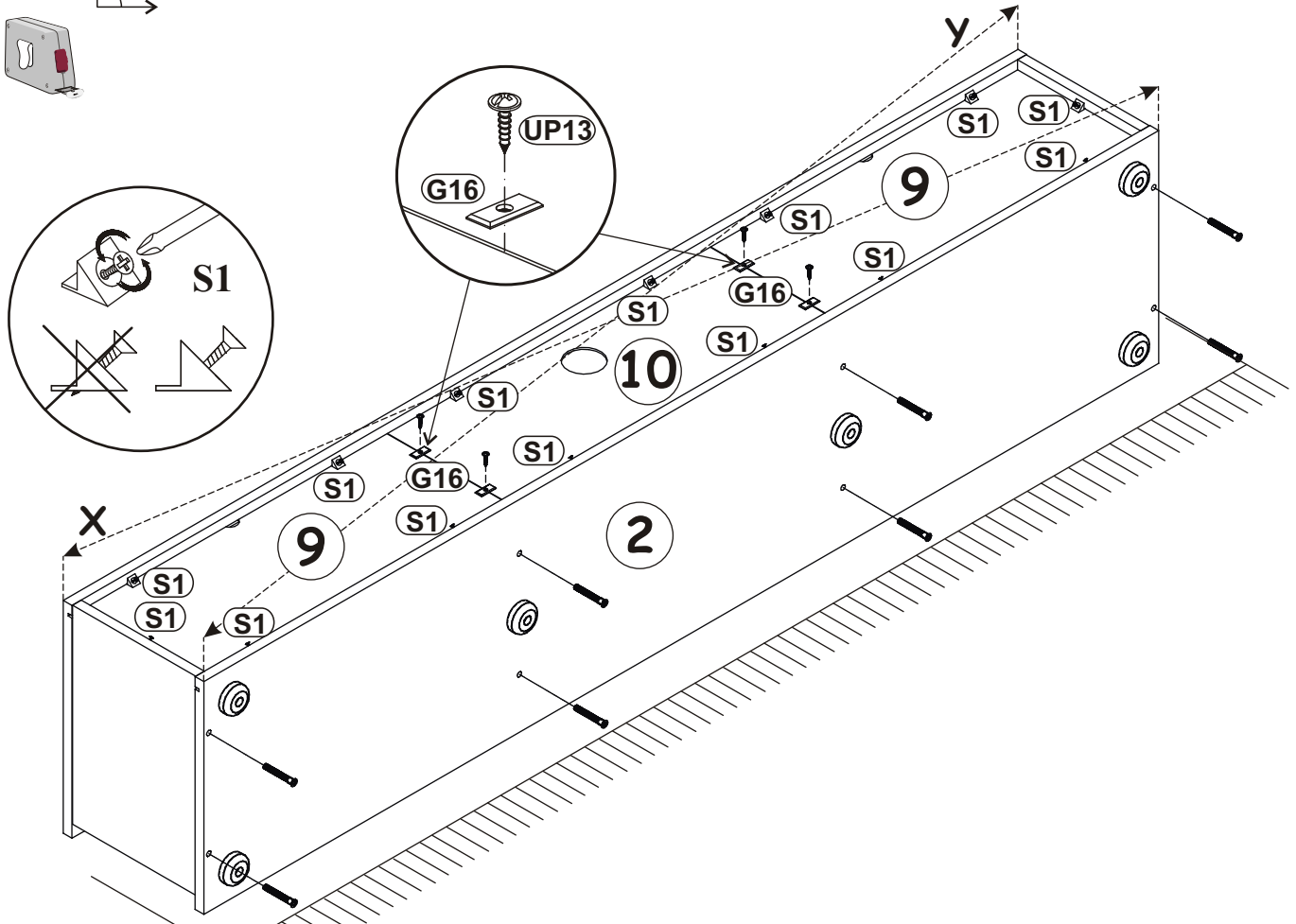



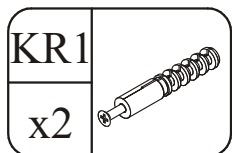
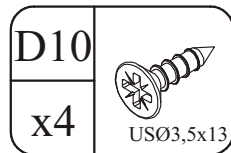
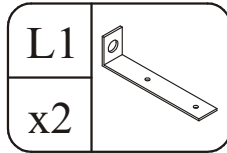

11

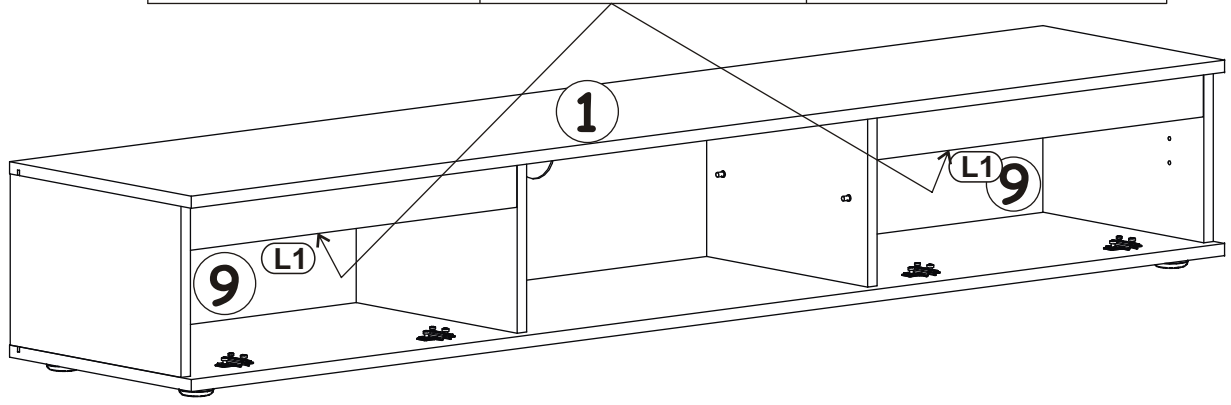
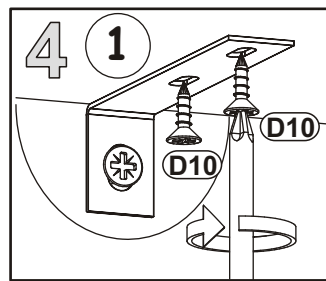
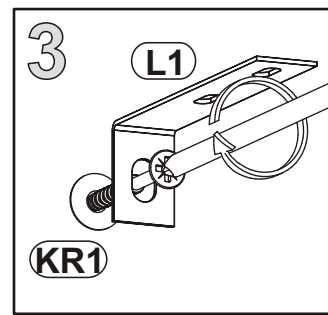
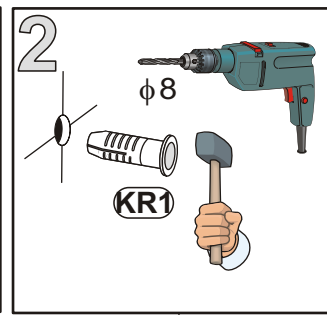
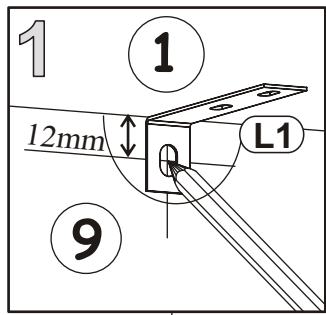
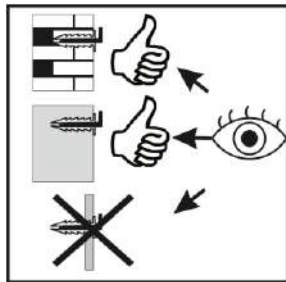

12

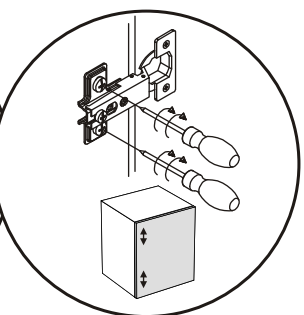
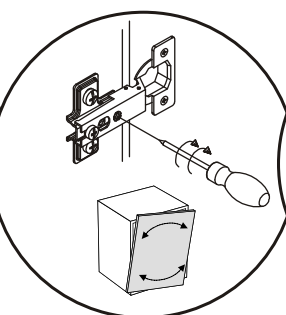
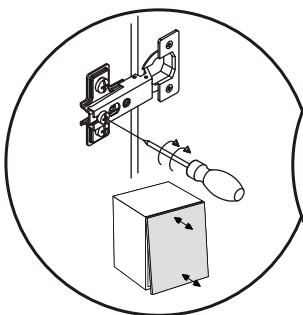
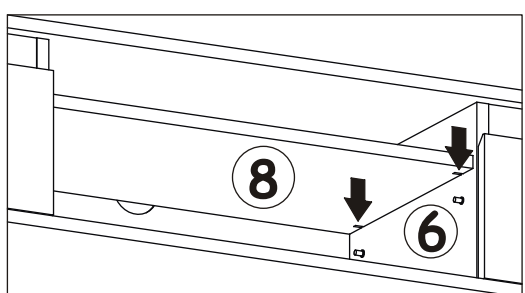
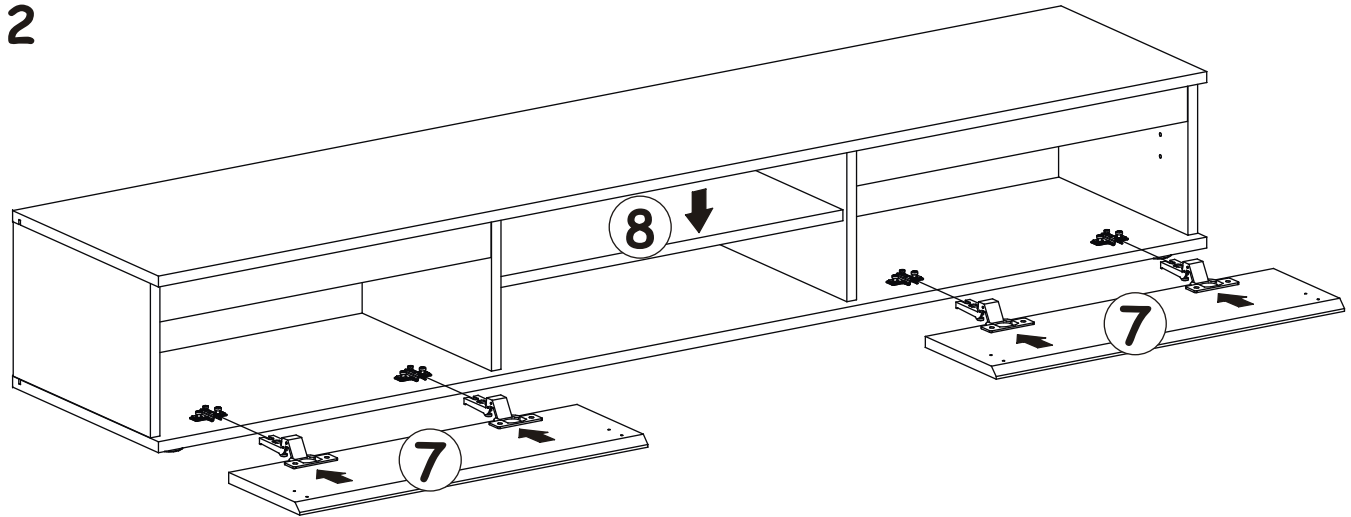

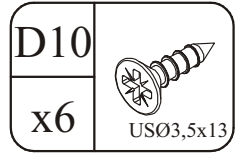
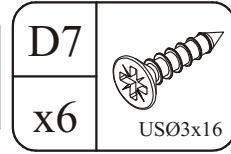
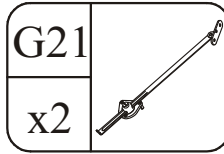

# 13

