

PALERMO 20 _PM TYP-01 ; TYP-02

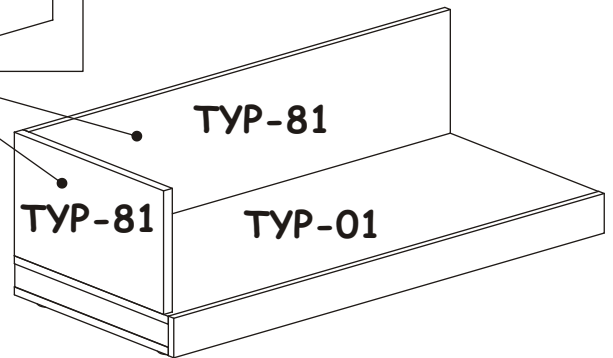

TYP-81

NO	Dim.			Col-No	Qty
10	1058	250	16	6	1
11	250	436	22	6	1

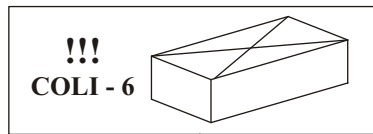
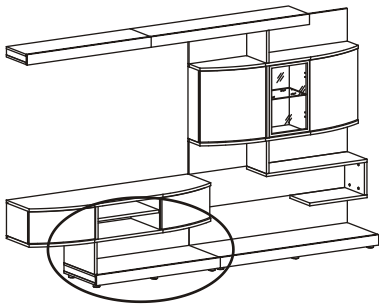
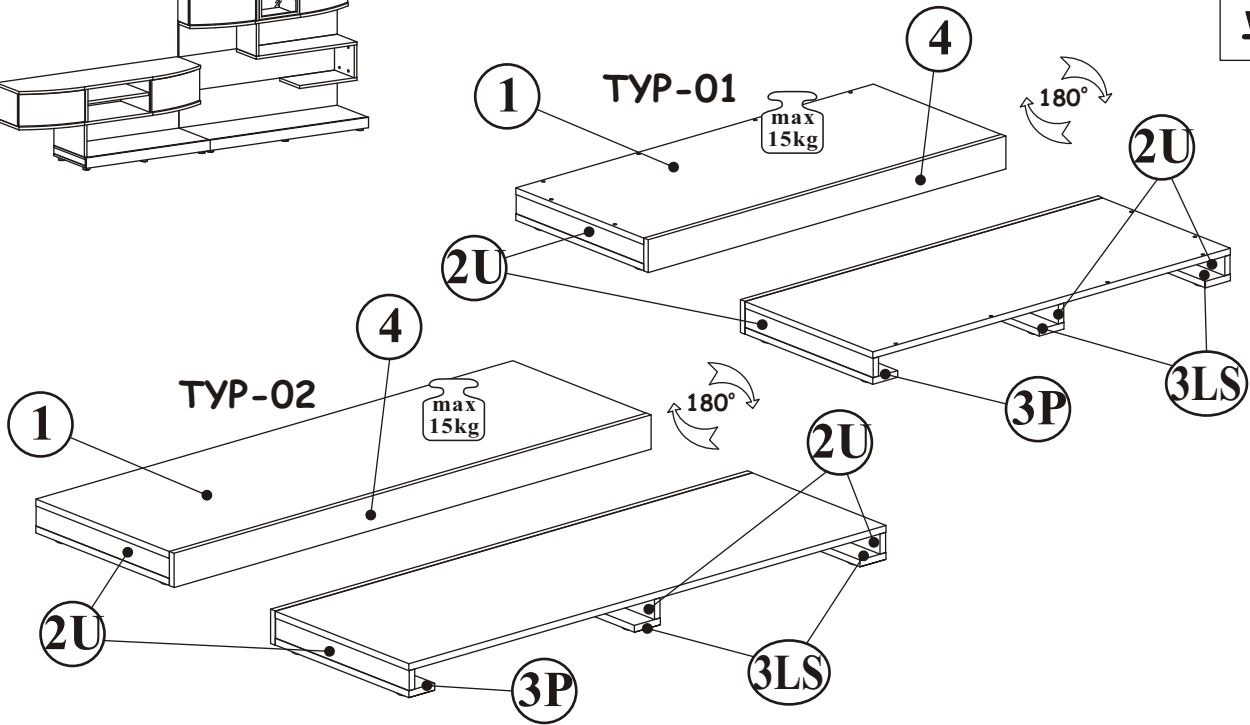
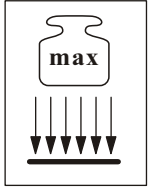
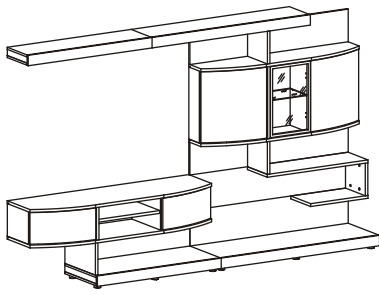
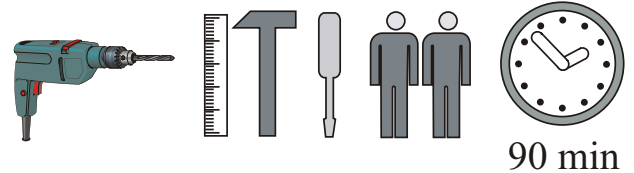

90 min







TYP-01

NO	Dim.			Col-No	Qty
1	1080	450	16	5	1
2U	450	47	16	5	3
3LS	450	75	16	5	2
3P	450	75	16	5	1
4	1080	80	16	5	1

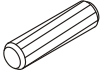
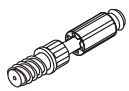
TYP-02

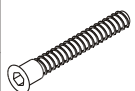
NO	Dim.			Col-No	Qty
1	1380	450	16	5	1
4	1380	80	16	5	1
2U	450	47	16	5	3
3LS	450	75	16	5	2
3P	450	75	16	5	1

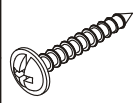
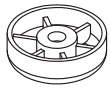
PALERMO 20 __PM TYP-01;TYP-02

A1 x40  ø8x36	B4 x28 	B5 x28  ø15x12	G5 x22 	B11 x18  Ø7x50	G4 x18 
UP11 x12  UPØ4x20	I11 x12  Ø50, h=25	G2 x1 			

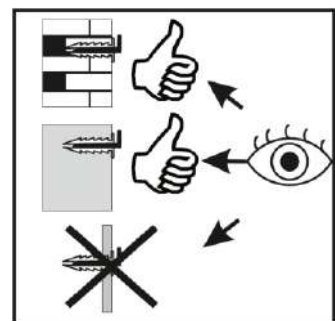
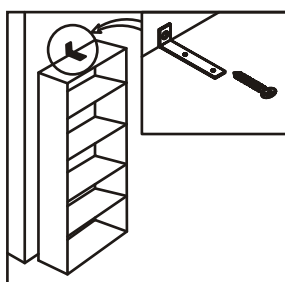
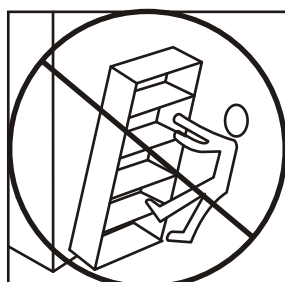
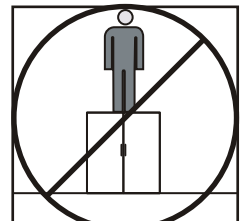
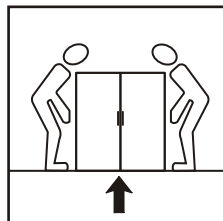
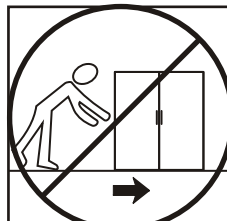
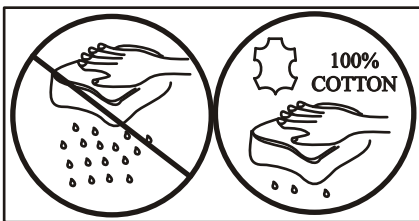
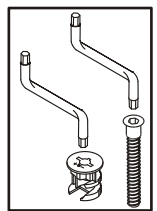
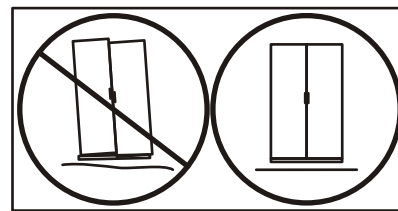
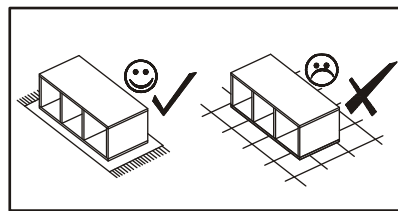
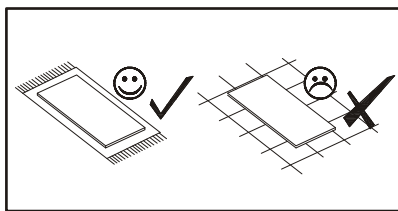
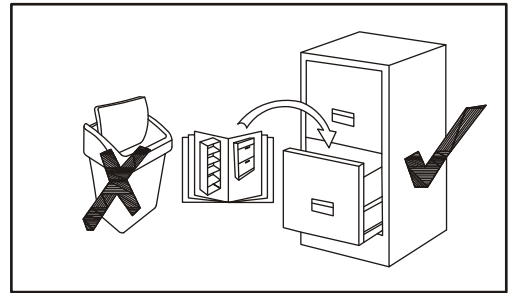
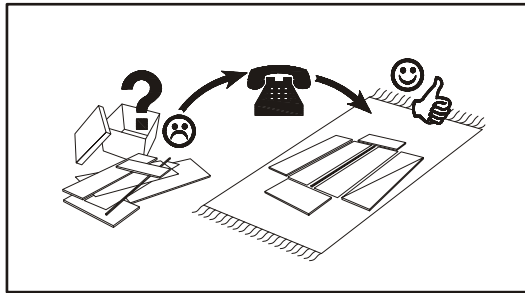
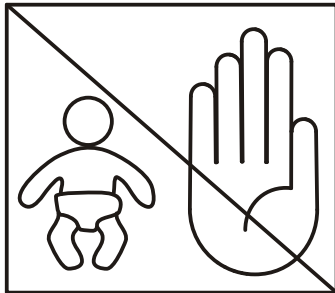
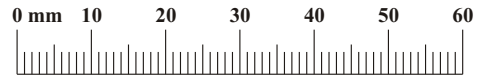

PALERMO 20_PM TYP-01;TYP-02

1

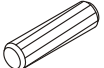
B5		A1	
x8	ø15x12	x8	ø8x36

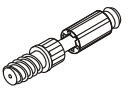
B4	
x26	

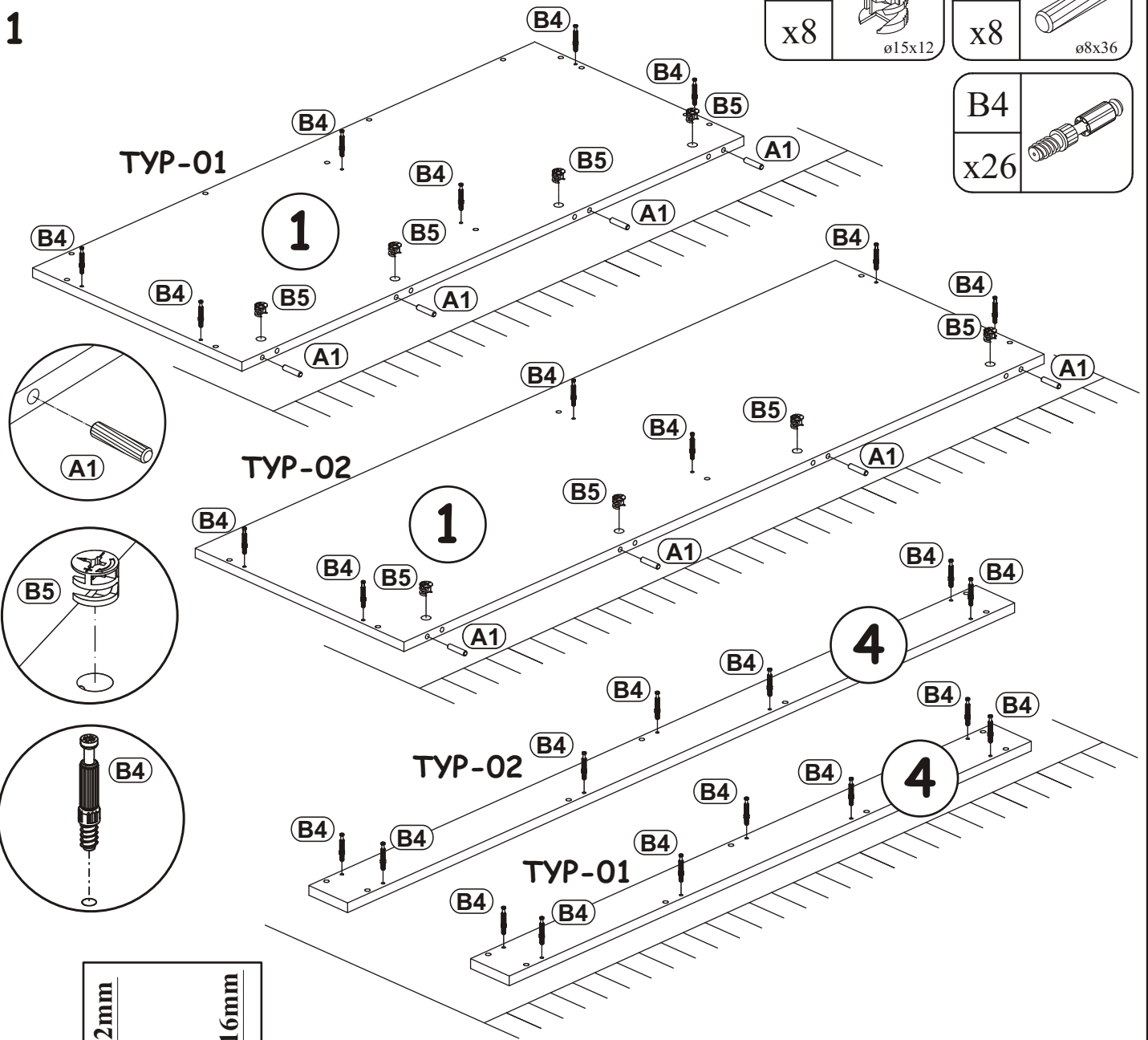

2

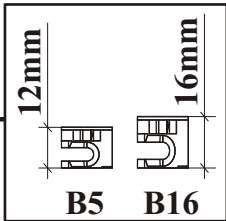

B5		A1	
x6	ø15x12	x6	ø8x36

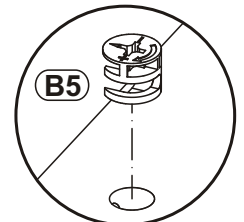
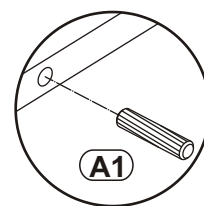
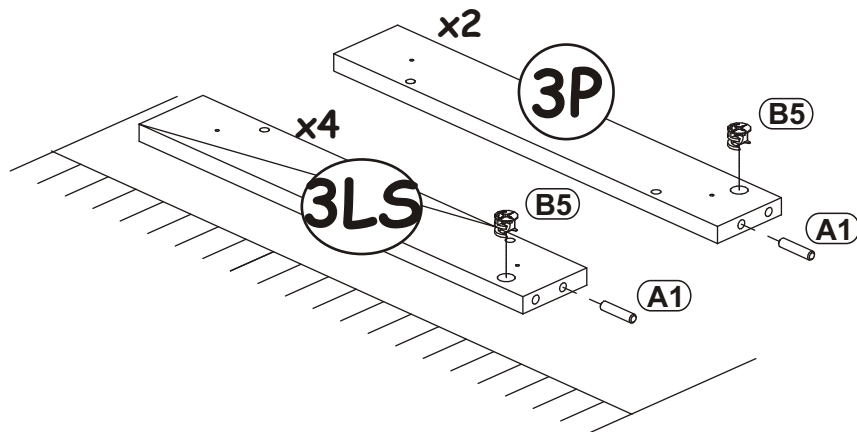

3

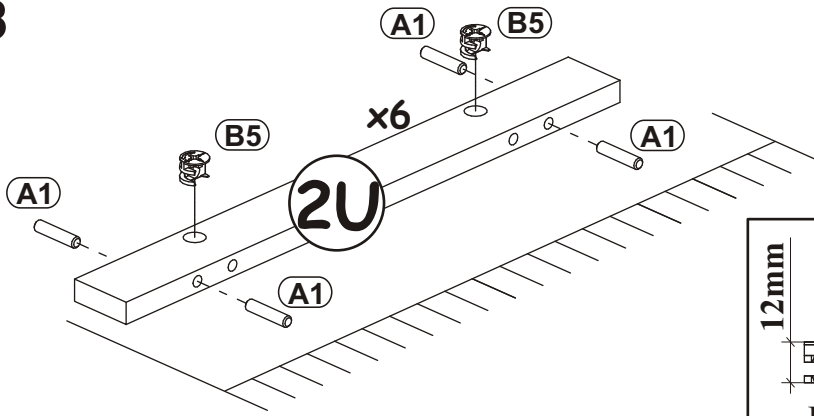

B5		A1	
x12	ø15x12	x24	ø8x36

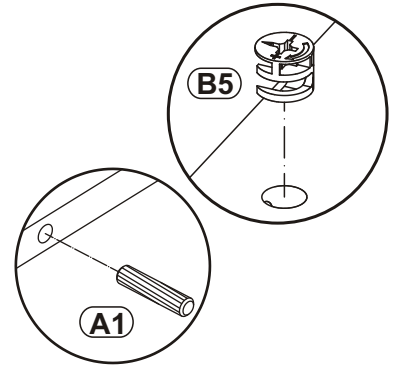
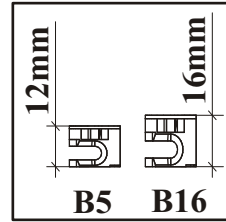

4

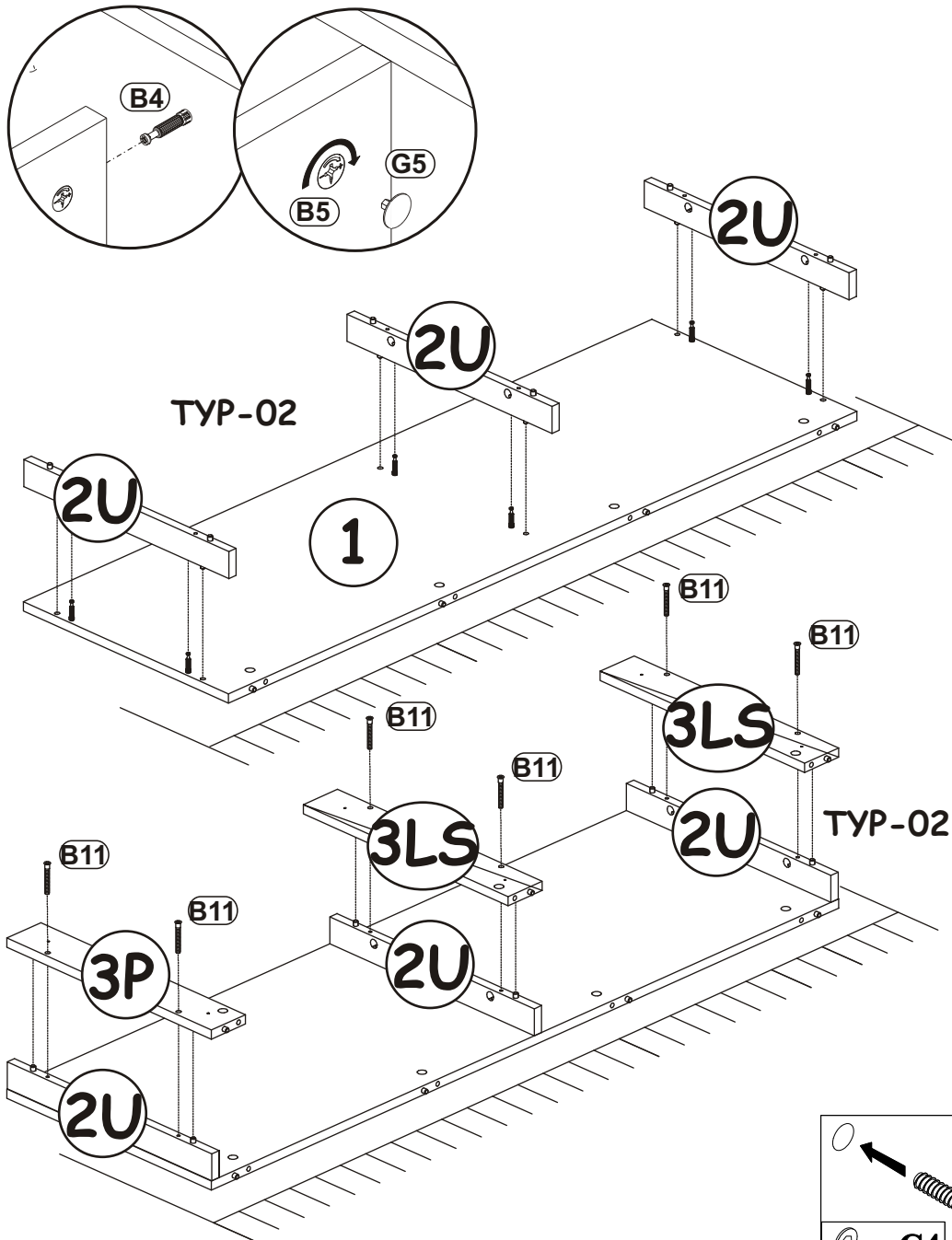

G5	
x6	

B11	
x6	Ø7x50

G4	
x6	

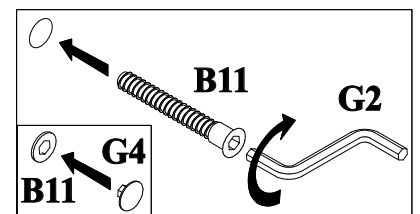

G5	
x4	

5

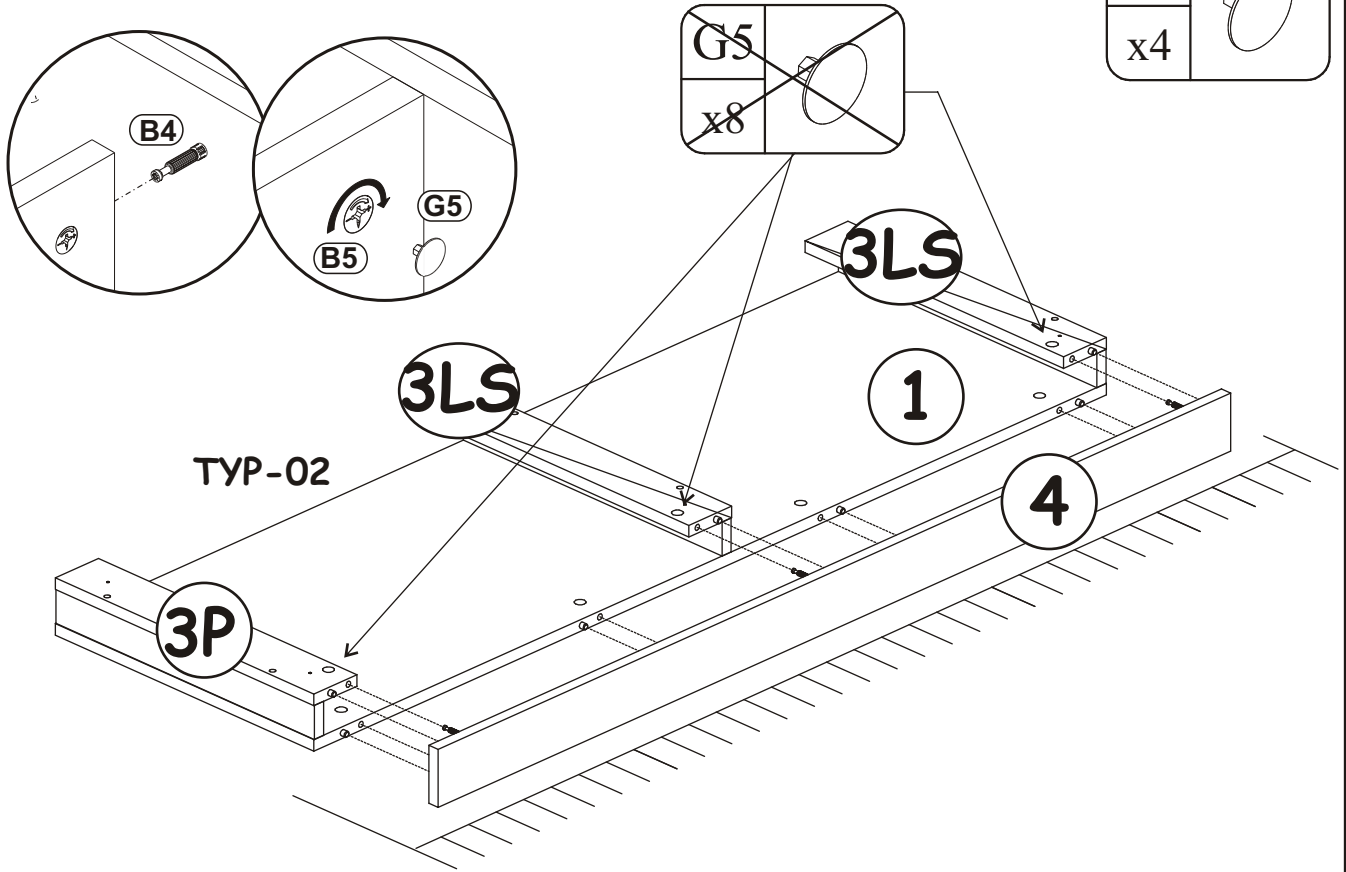

6

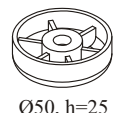
UP11		I11	
x6	UPØ4x20	x6	Ø50, h=25

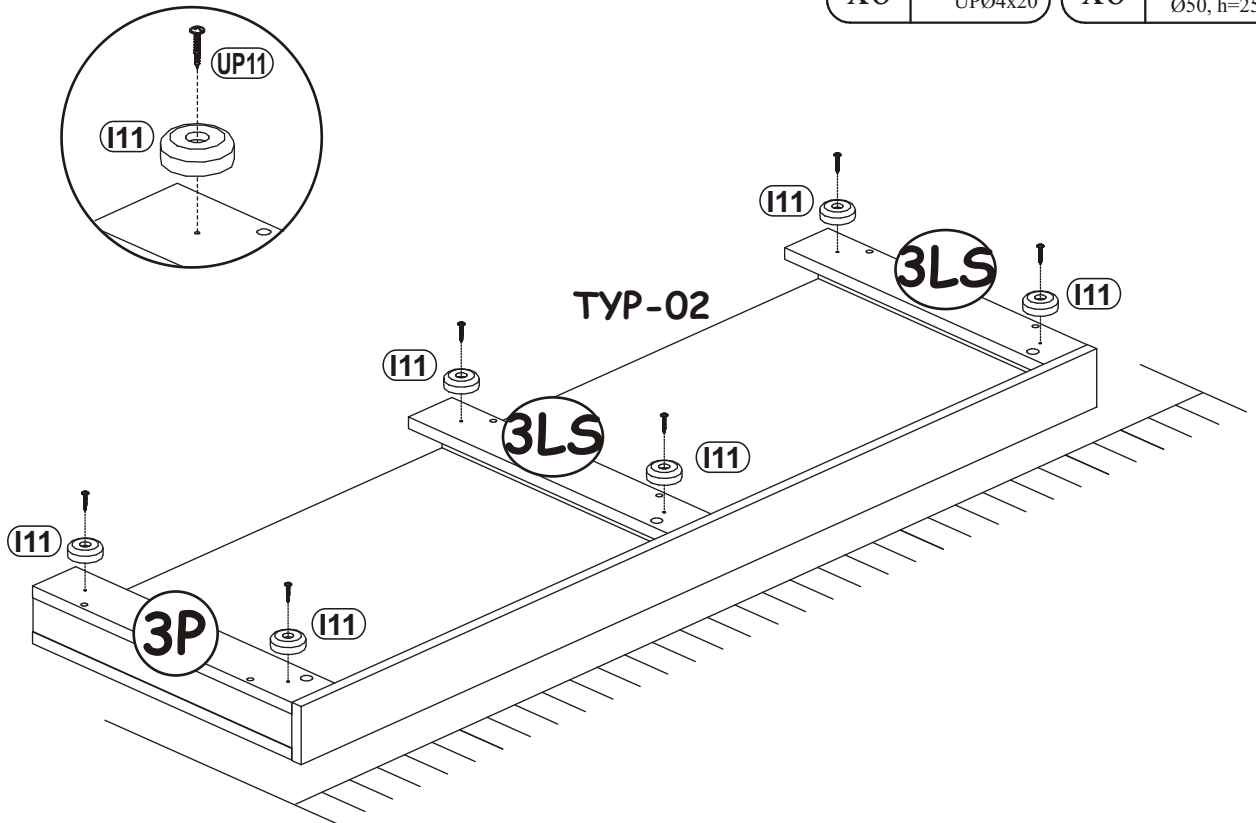

7

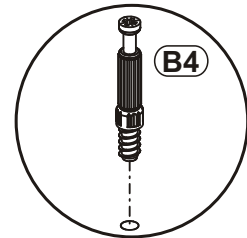
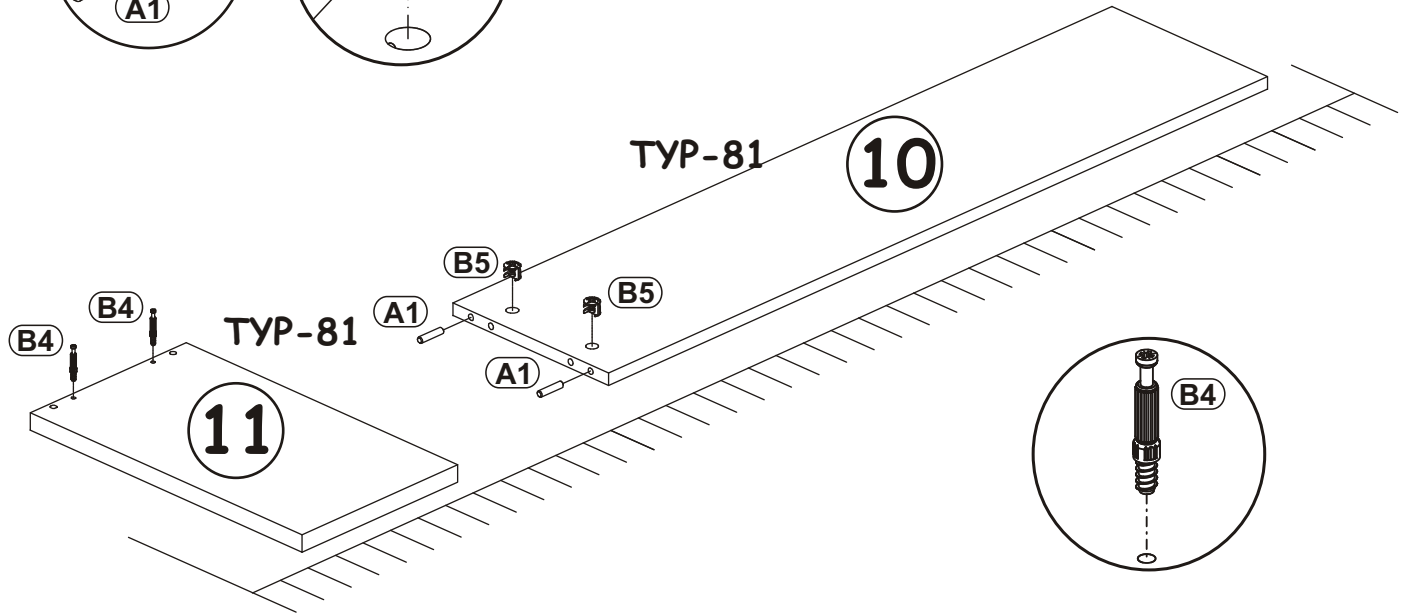
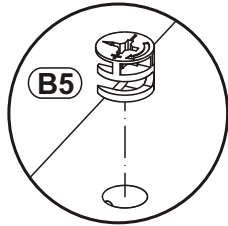
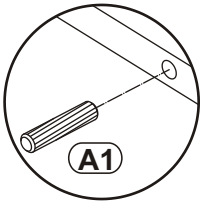
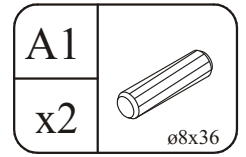
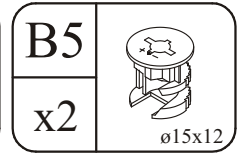
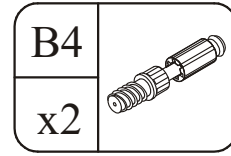

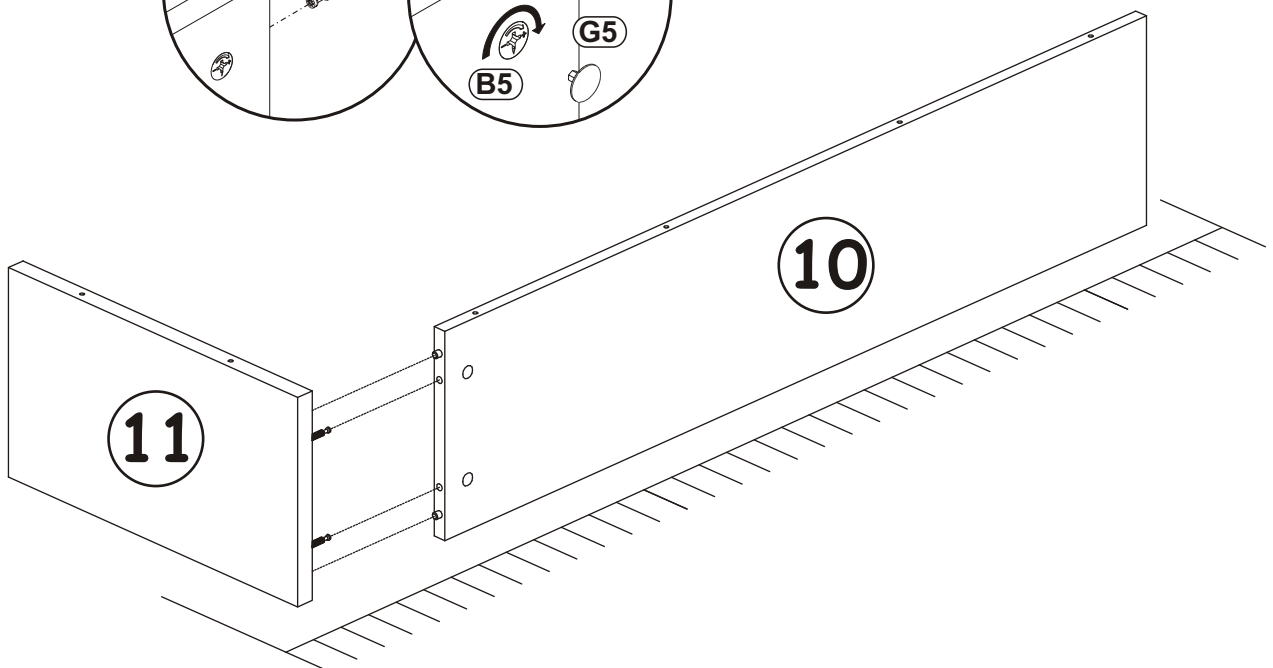
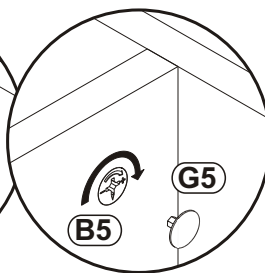
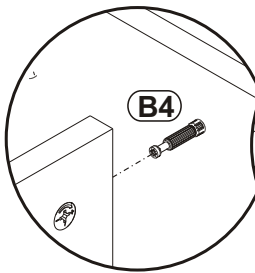
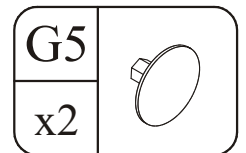

8

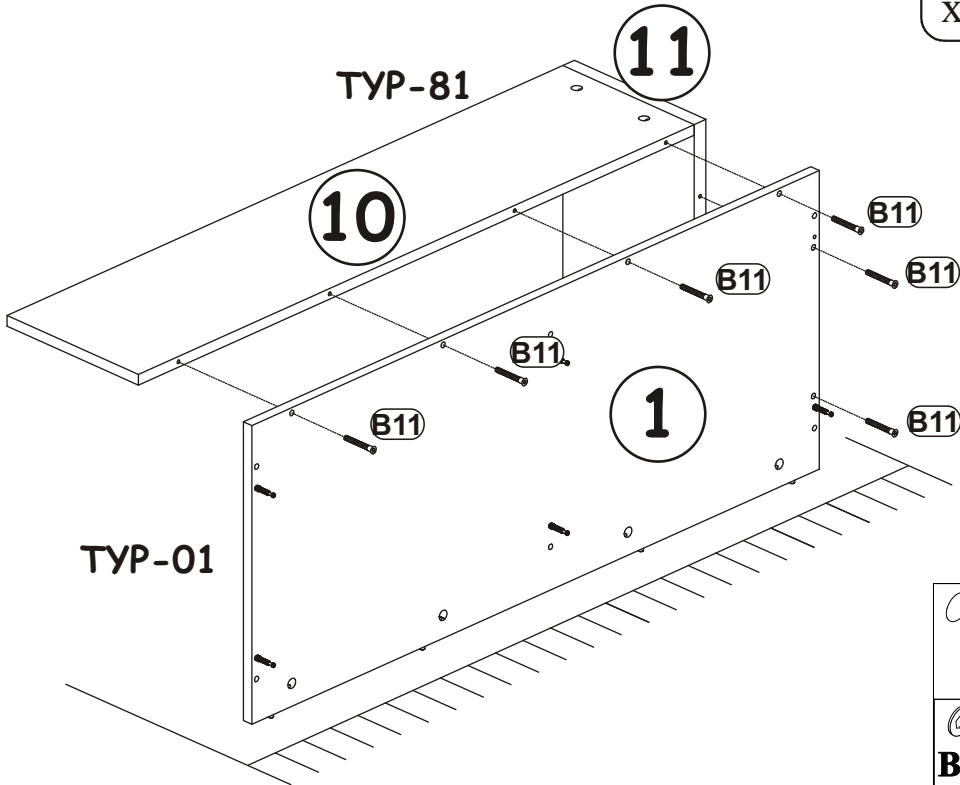

9



B11		G4	
x6	Ø7x50	x6	

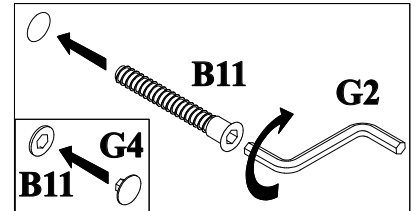

10

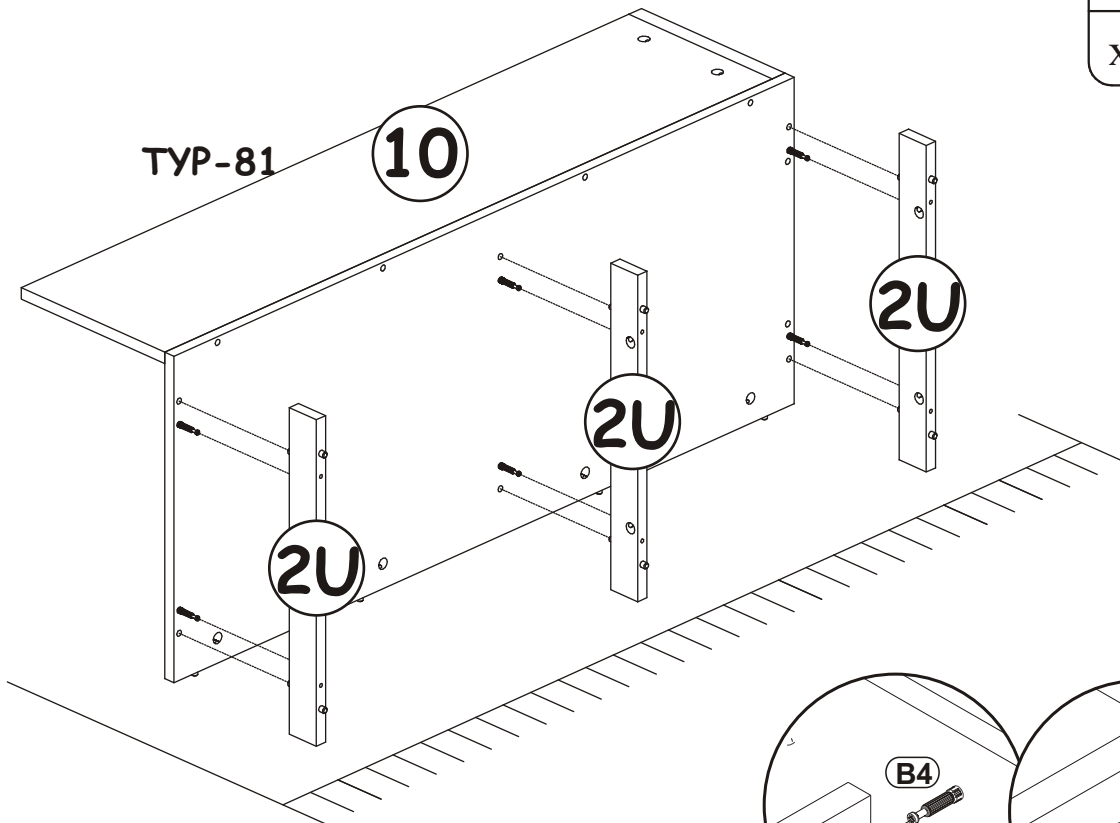

G5	
x6	

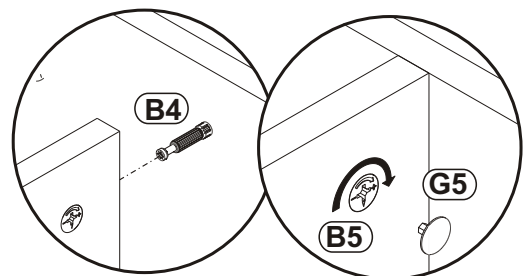

11

B11	
x6	Ø7x50

G4	
x6	

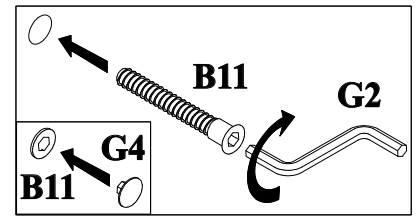
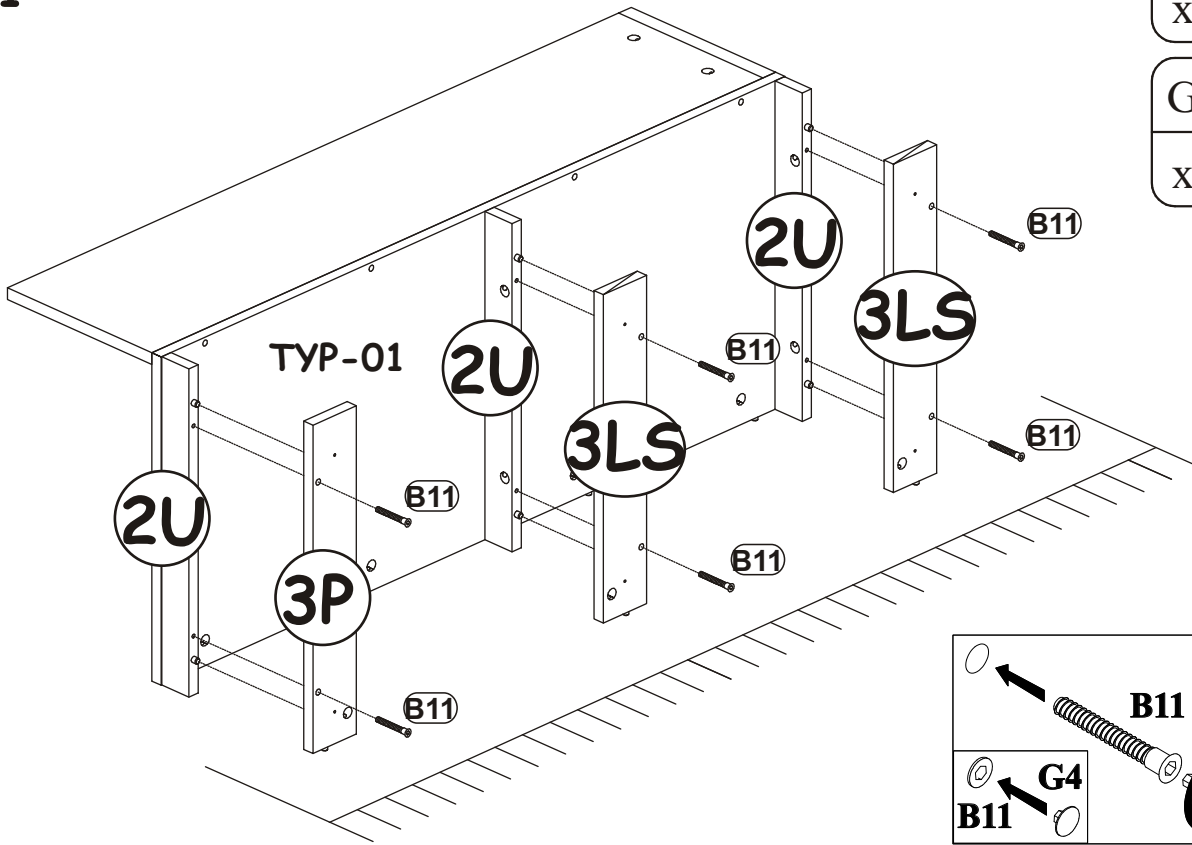

12

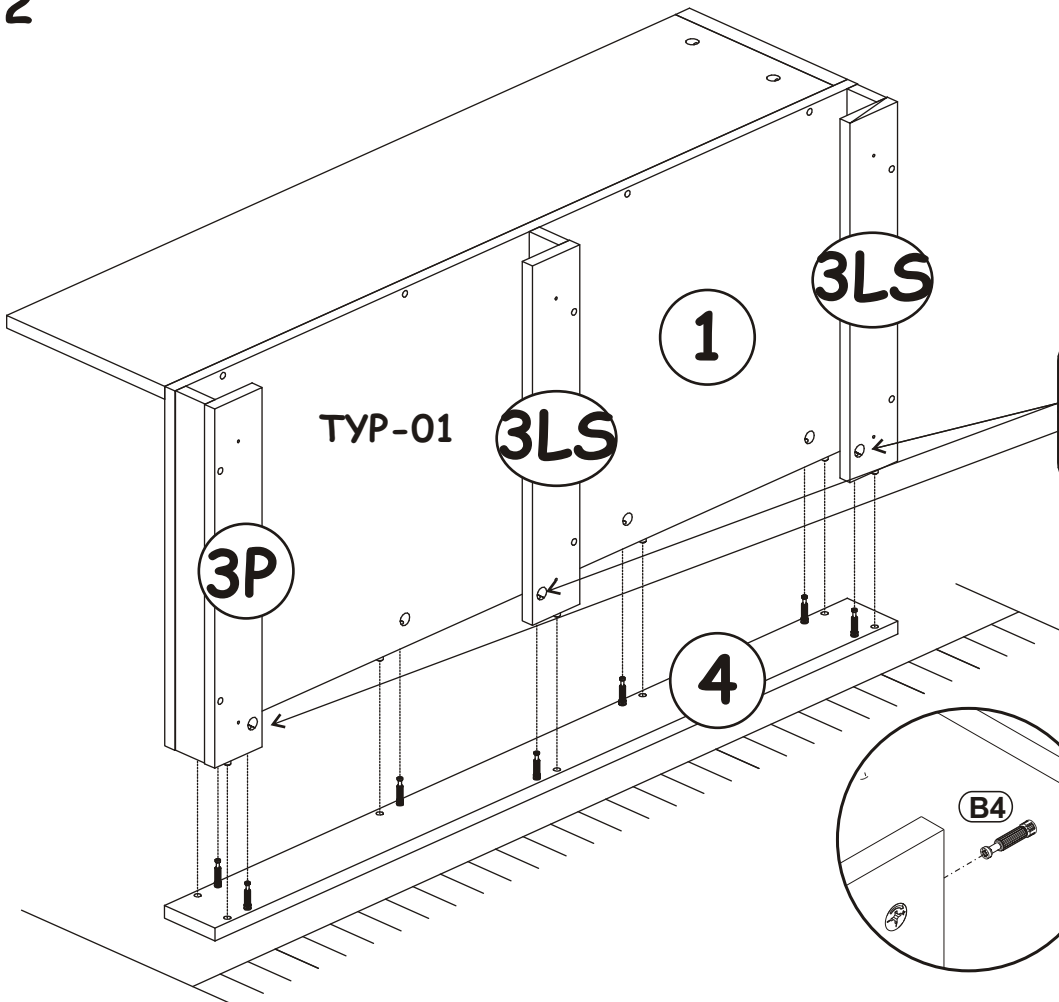

G5	
x4	

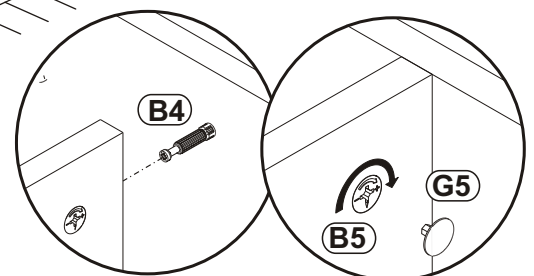

G5	
x8	



13

UP11		I11	
x6	UPØ4x20	x6	Ø50, h=25

