

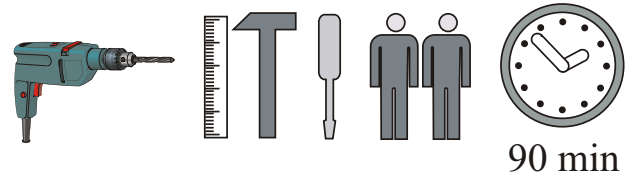

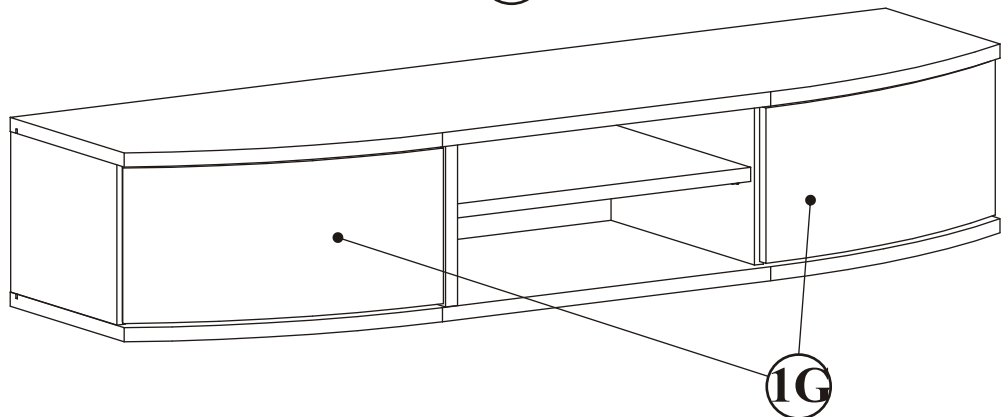

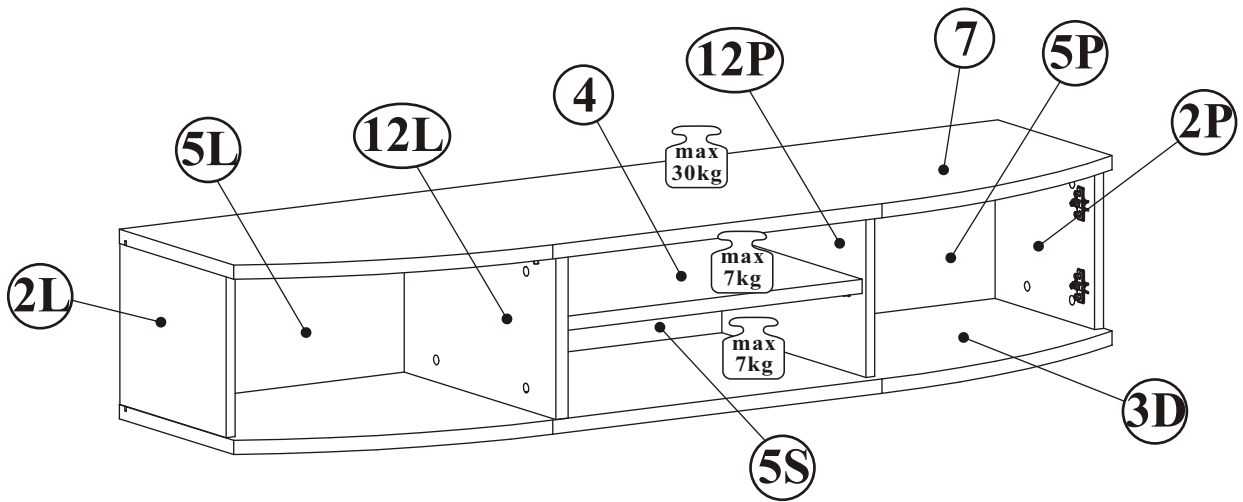

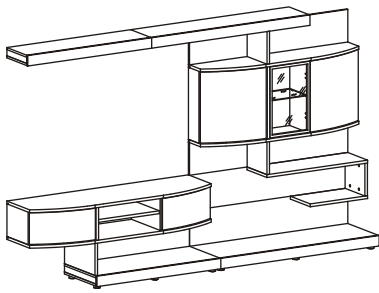

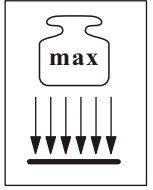
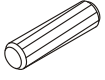
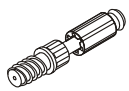

# PALERMO 20\_PM TYP-30

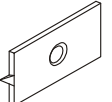
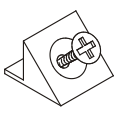

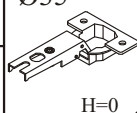
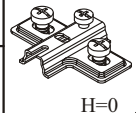
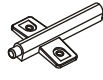
NO	Dim.			Col-No	Qty
2L	250	303	16	1	1
2P	250	303	16	1	1
12L	250	432	22	1	1
12P	250	410	16	1	1
3D	1580	453	22	1	1
4	549	400	22	1	1
7	1580	453	22	1	1
5L	262	496	3	3	1
5S	262	573	3	3	1
5P	262	490	3	3	1
1G	242	504	18	3	2

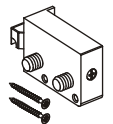
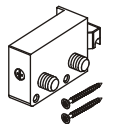
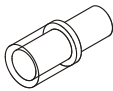
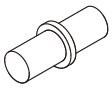
PALERMO 20\_\_PM TYP-30

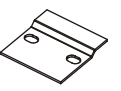
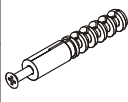
A1 x16  ø8x36	B4 x16 	B5 x12  ø15x12	G5 x16 	UP13 x4  UPØ3x16	G16 x4 
S1 x14 	D10 x12  USØ3,5x13	E21 x4  Ø35 H=0	E2 x4  H=0	T3 x2 	G2 x1 
ZXL x2 	ZXP x2 	G20 x1 	G7 x4 	B16 x4  Ø15x16	SZ7 x4 
KR1 x8 					

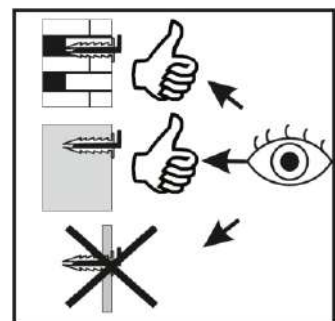
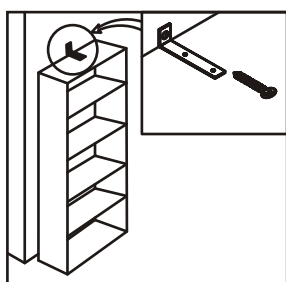
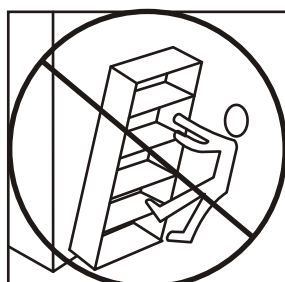
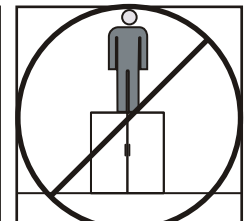
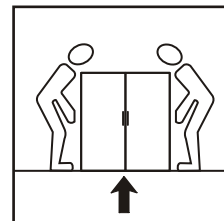
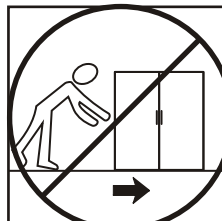
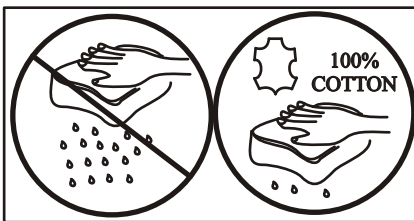
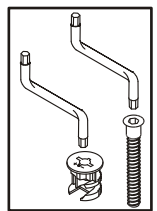
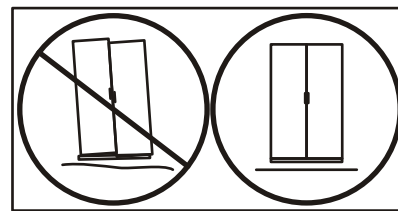
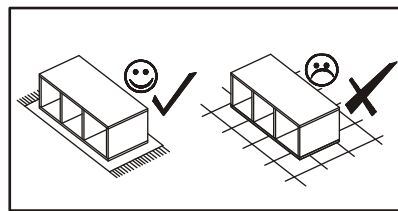
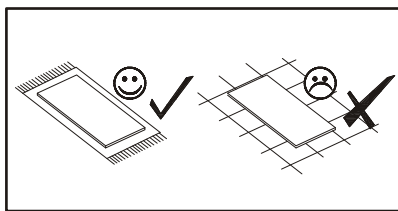
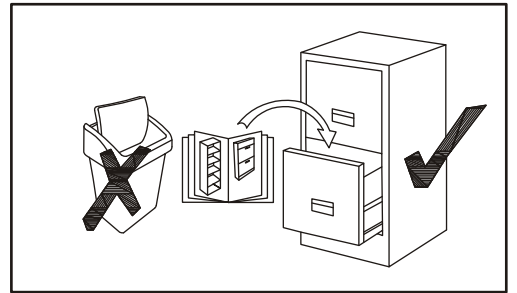
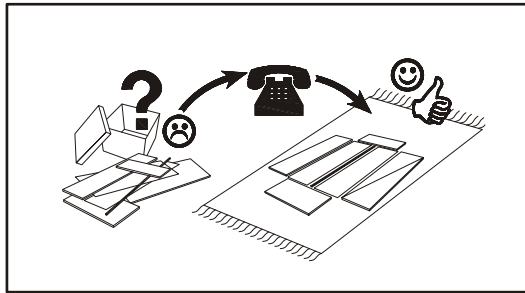
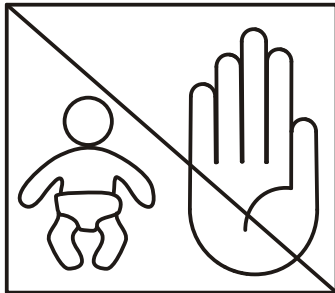
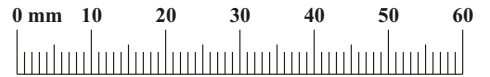

PALERMO 20\_\_PM TYP-30

1

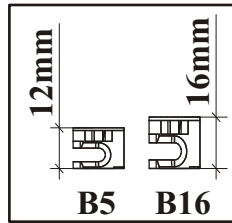
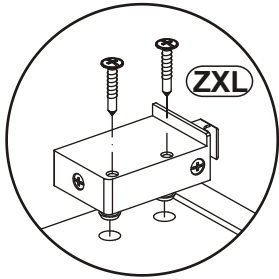

B5		A1	
x8	ø15x12	x8	ø8x36

ZXL		ZXP	
x1		x1	

E2	
x4	H=0

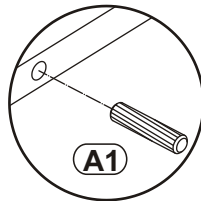
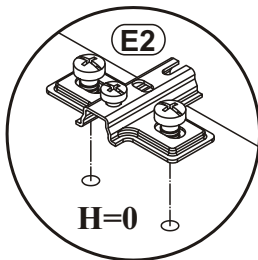
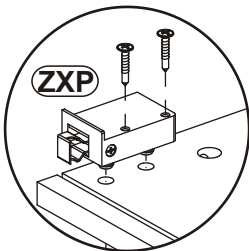
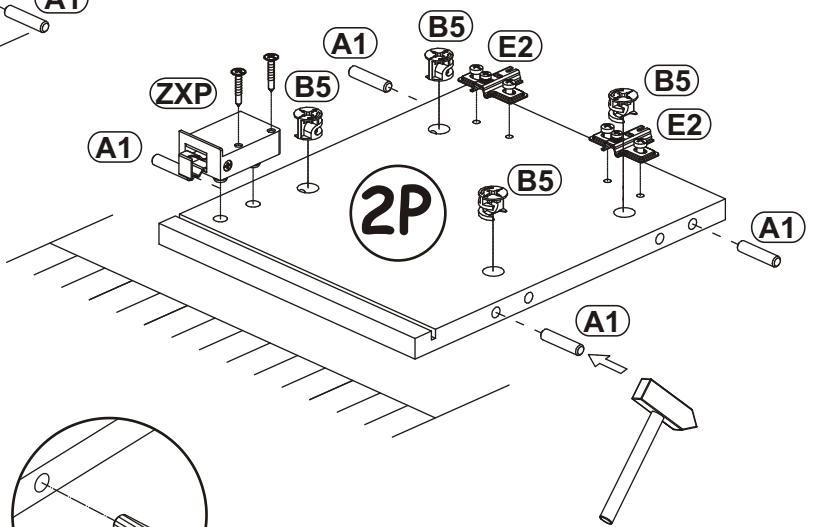
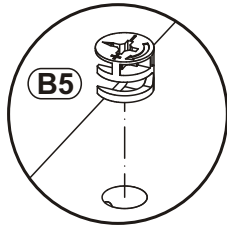
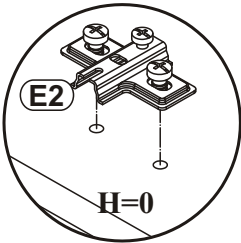
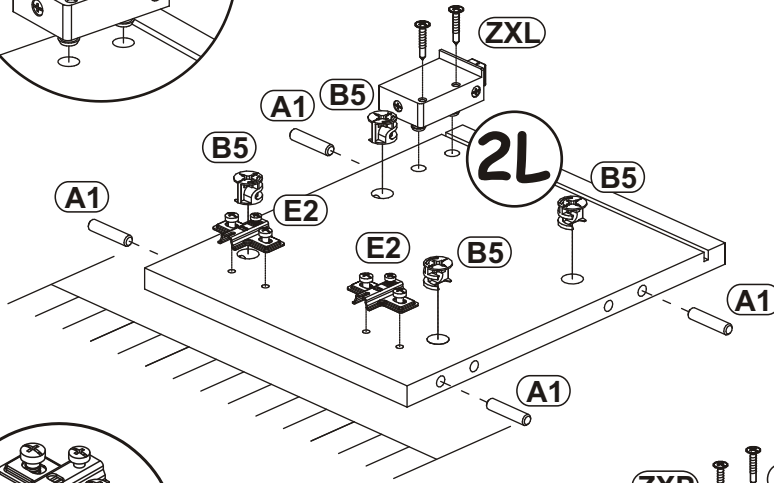

2

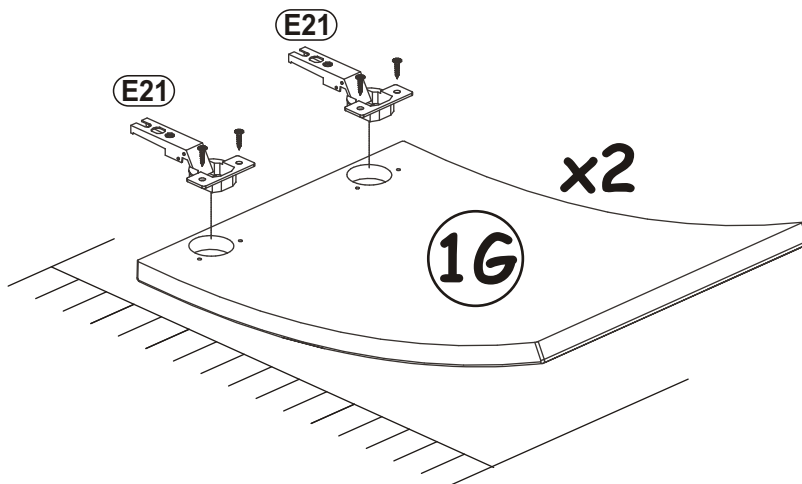

D10	
x8	USØ3,5x13

E21	
x4	Ø35 H=0

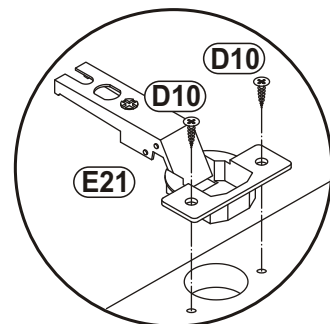

3

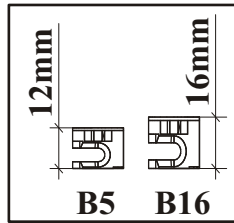

B5 x4	 ø15x12	A1 x8	 ø8x36
ZXL x1	 // //	ZXP x1	 // //
G7 x4		B16 x4	 Ø15x16

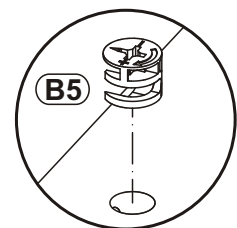
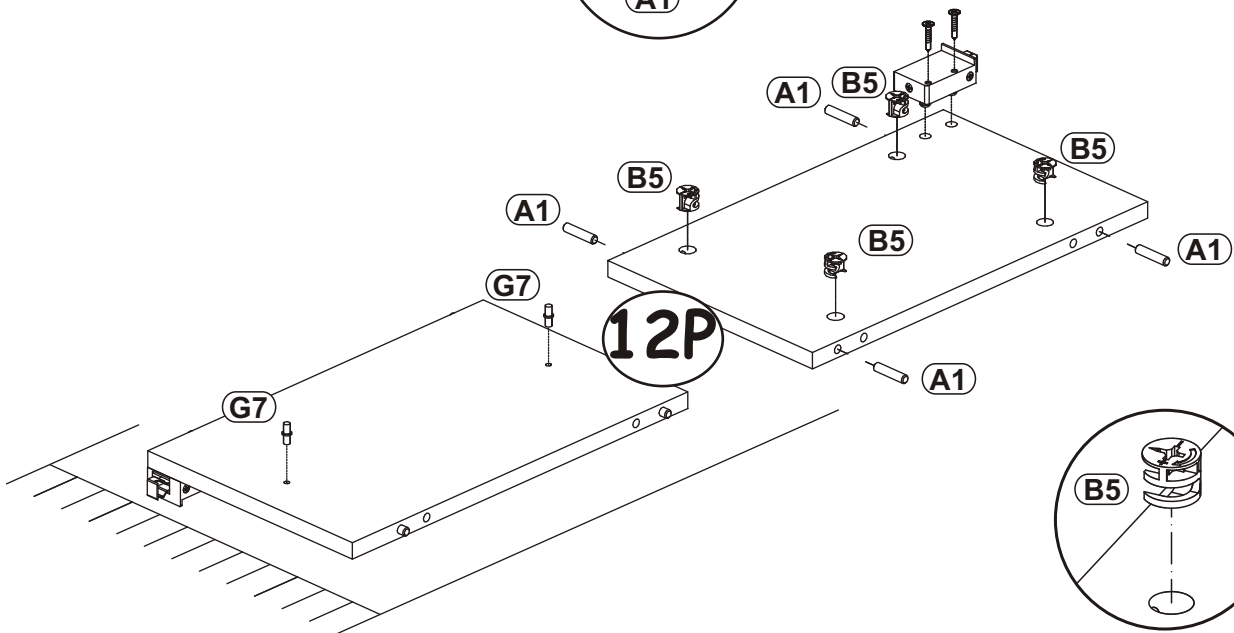
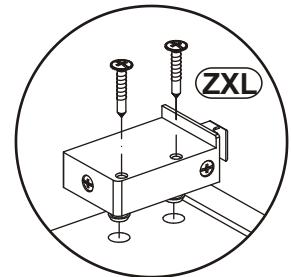
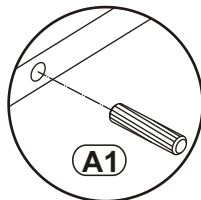
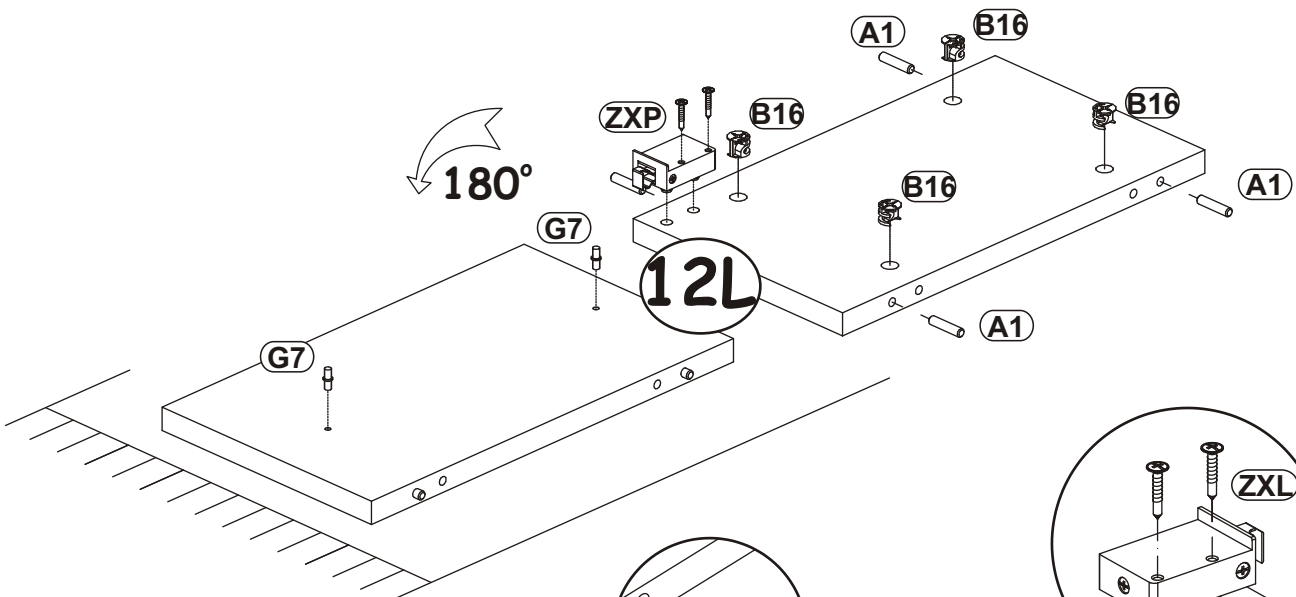
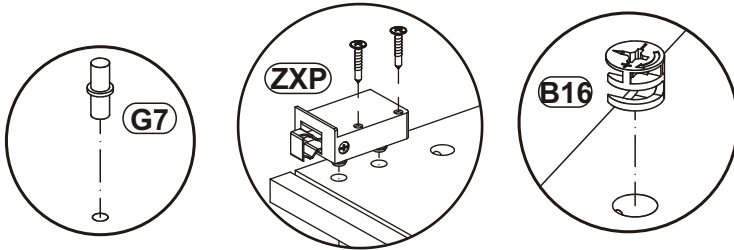

PALERMO 20\_\_PM TYP-30

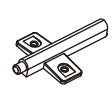
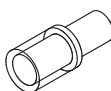
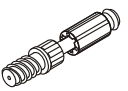
T3		G20		B4	
x2		x1		x16	

D10	
x4	USØ3,5x13

4

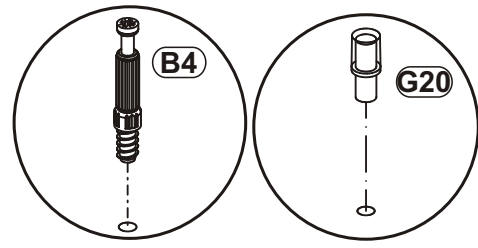
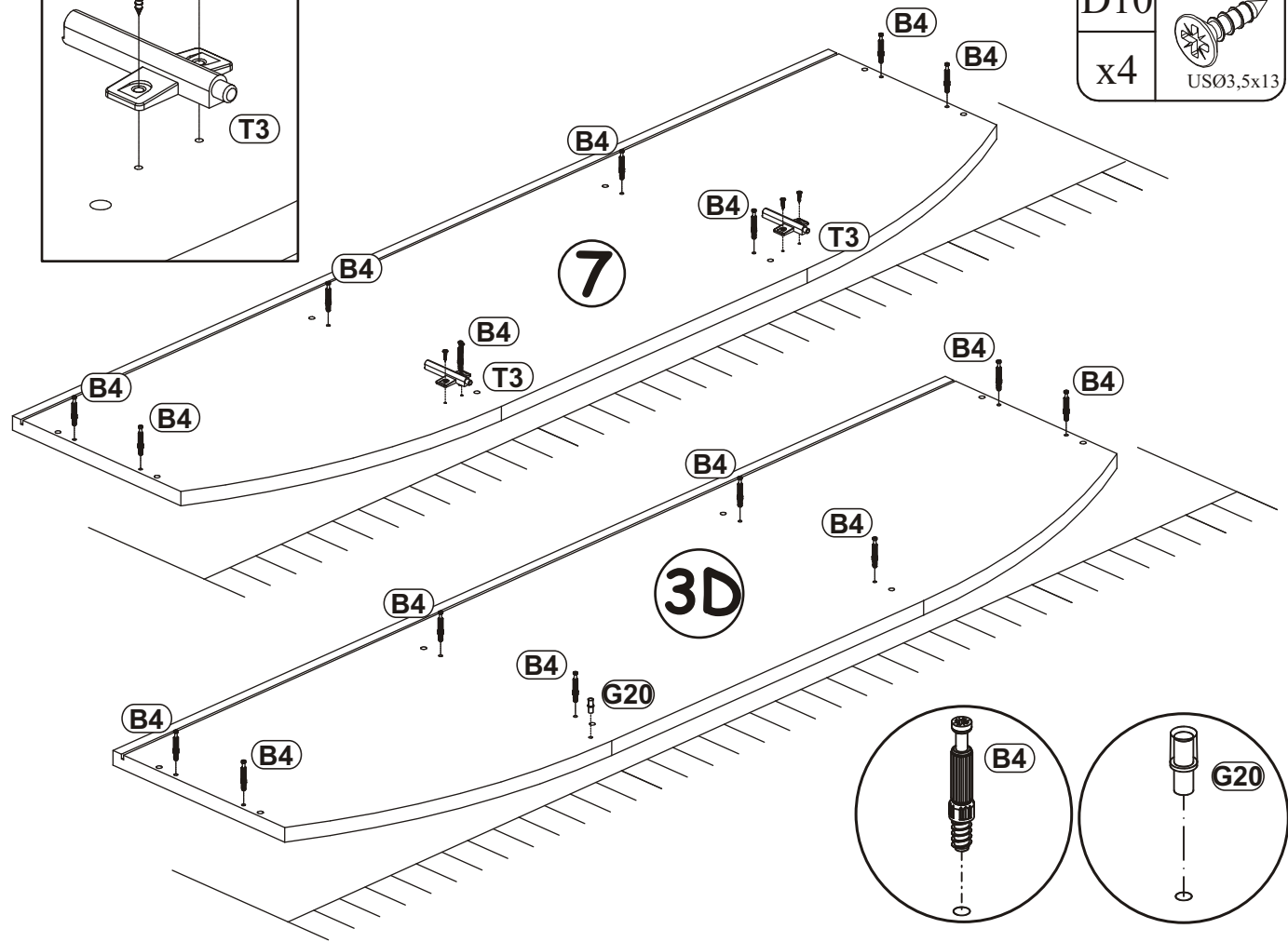
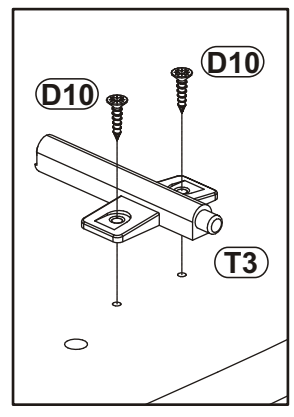

5

G5	
x8	

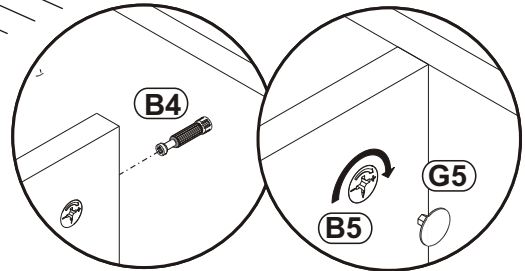
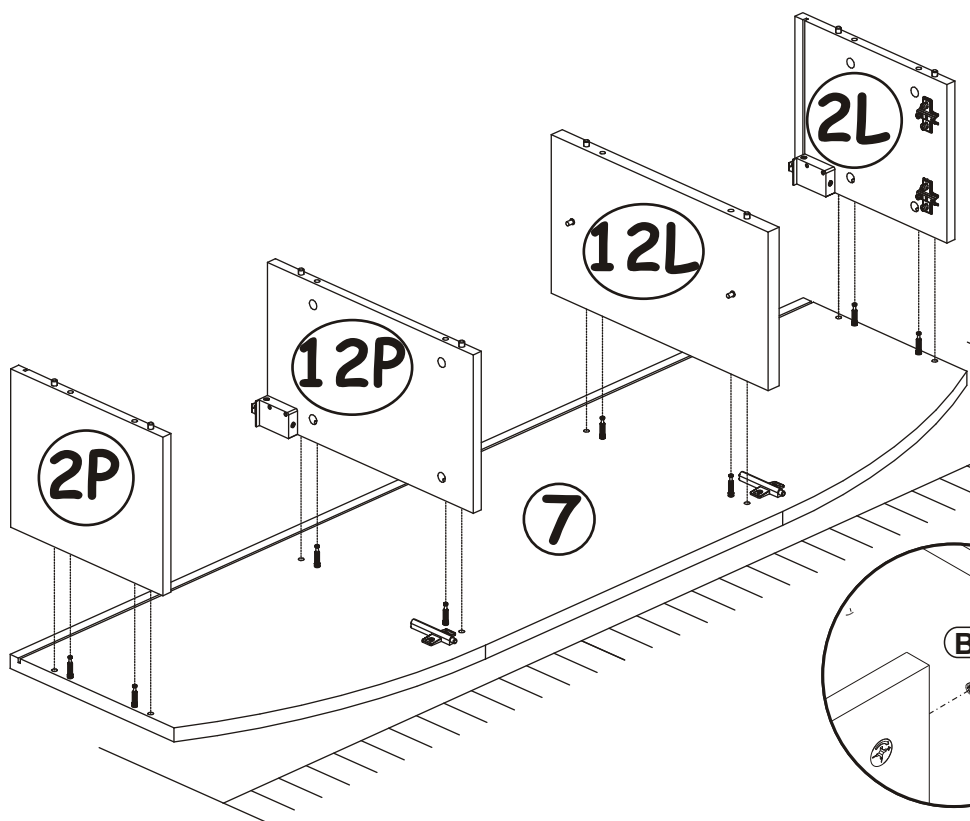

6

G5	
x8	

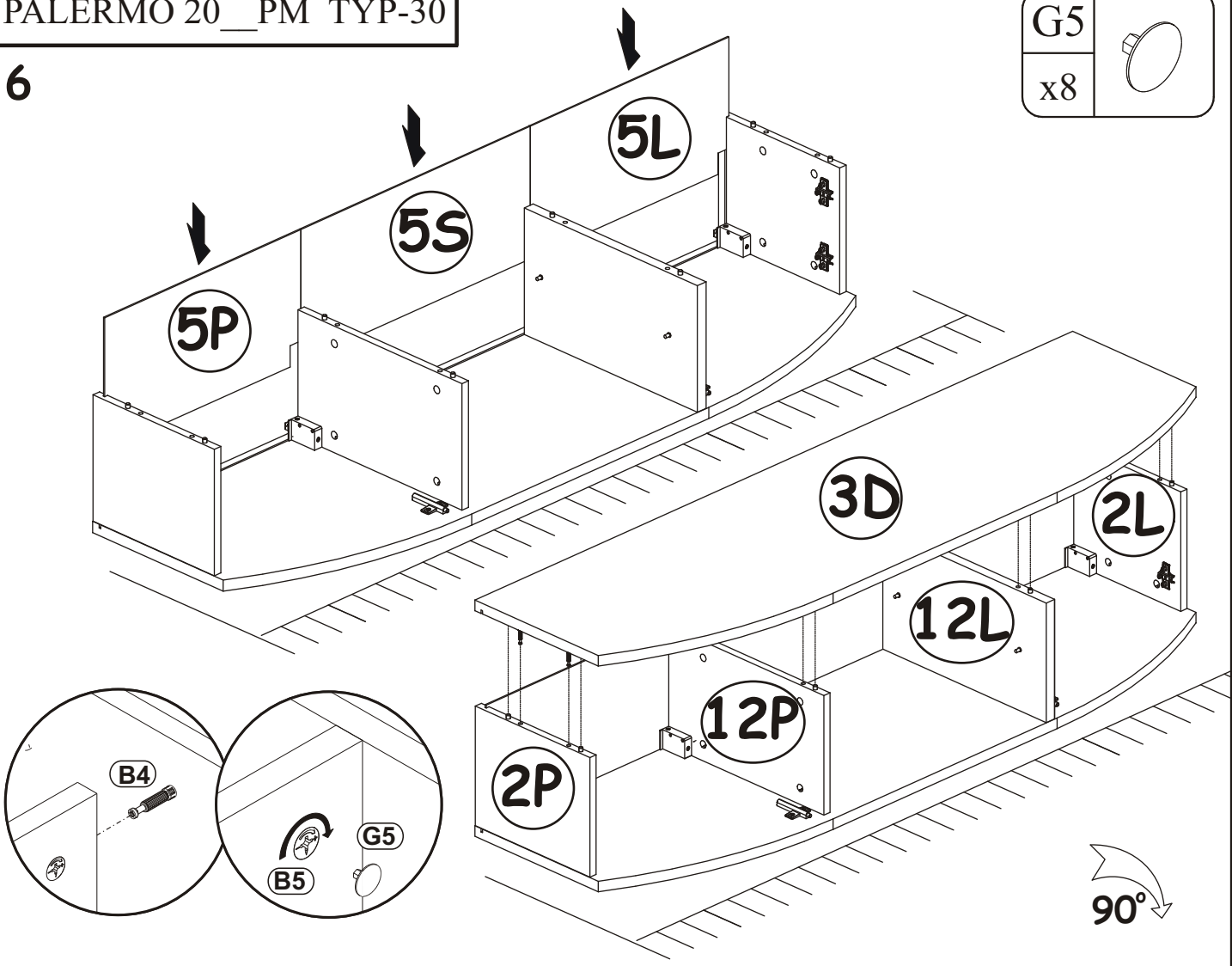

90°

7

UP13	
x4	UPØ3x16

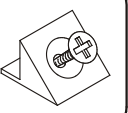
S1	
x14	

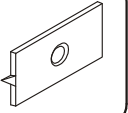
G16	
x4	

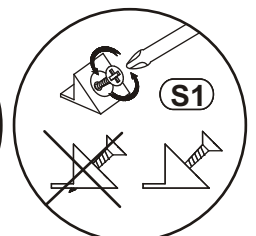
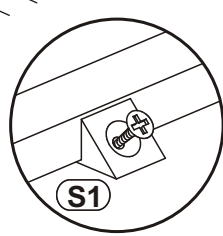
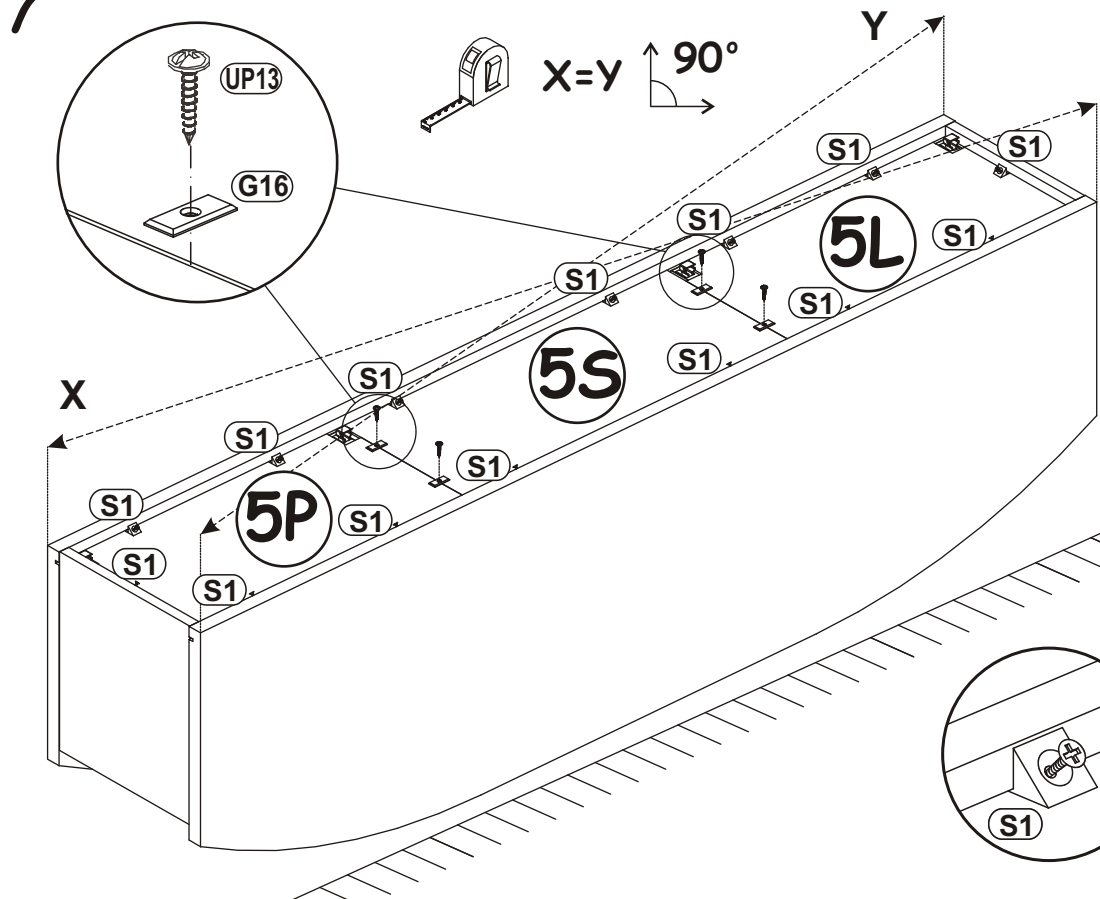

8

