

QUILL TYP 70; 71; 72

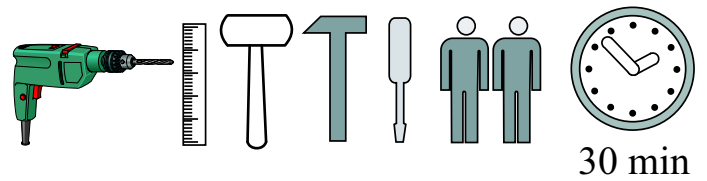

NO	Dim.			Col.-No	Qty
5P	200	300	22	1	2
5	422	300	22	1	1
4Z	1100	200	16	1	1
4	1100	200	16	1	1

QUILL TYP 70; 71; 72

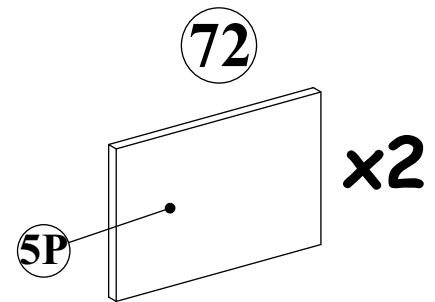
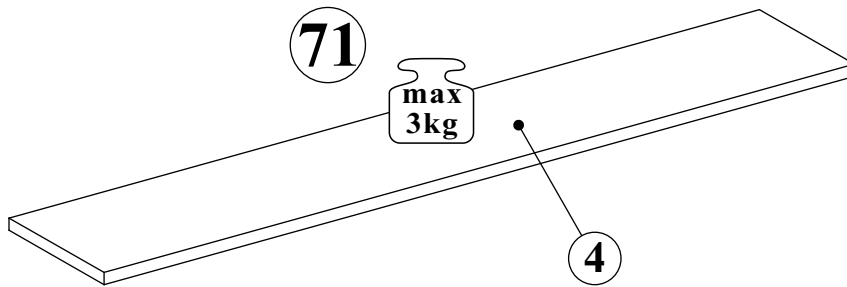
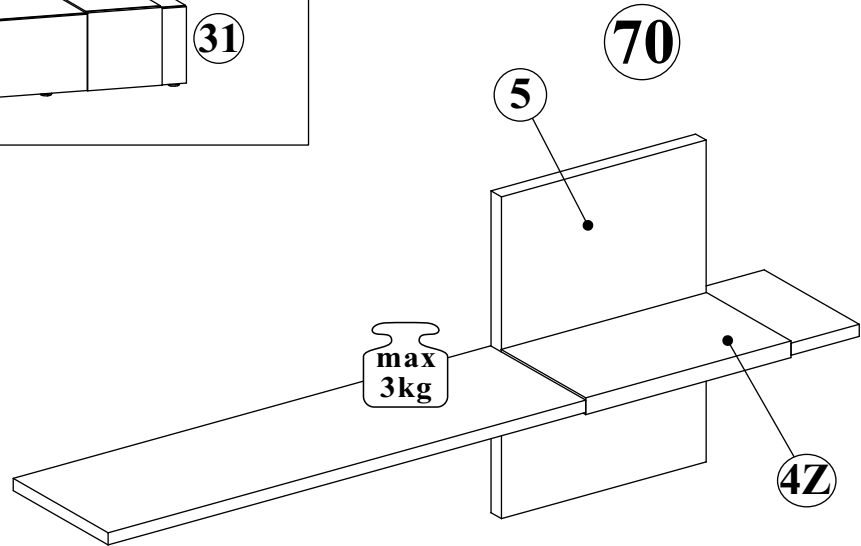
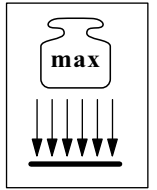
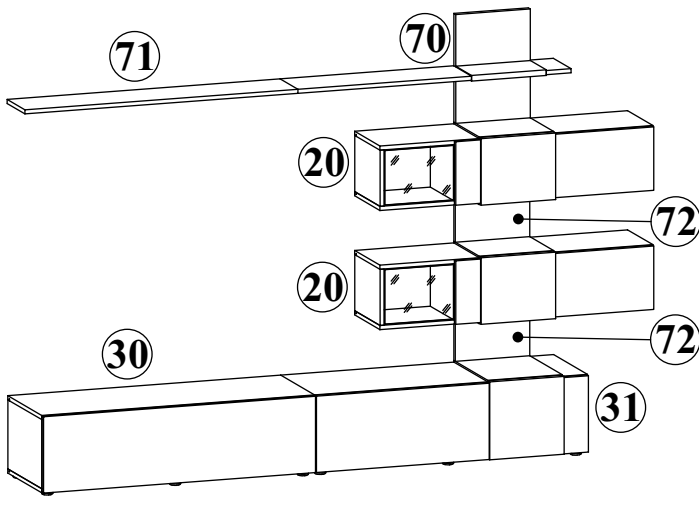
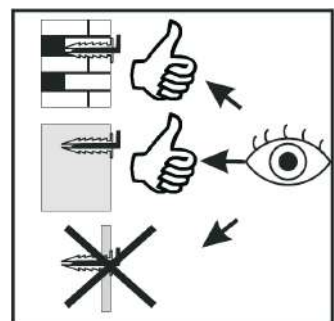
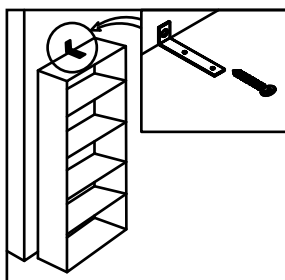
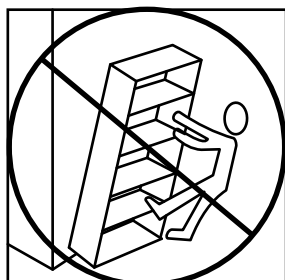
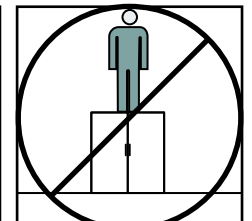
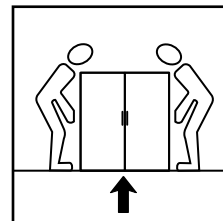
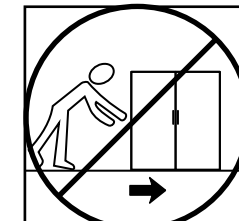
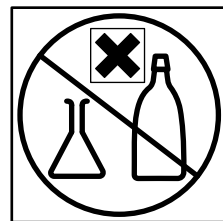
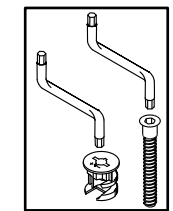
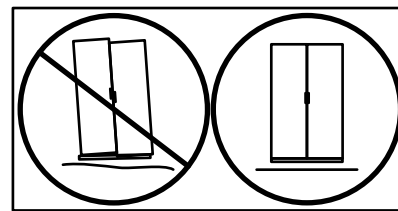
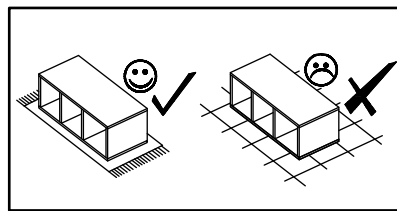
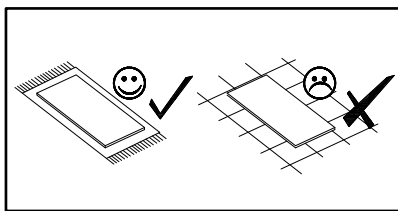
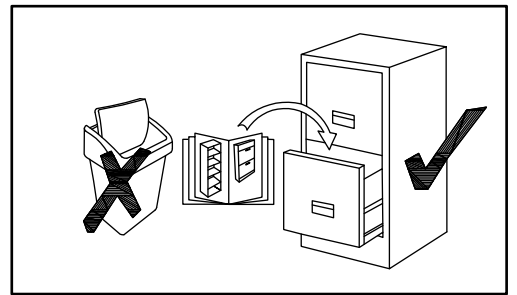
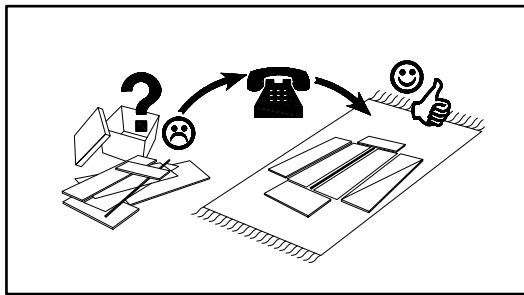
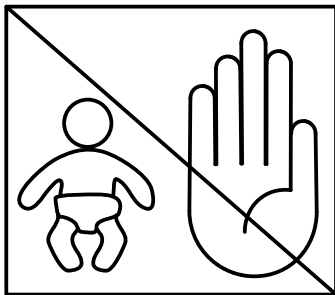
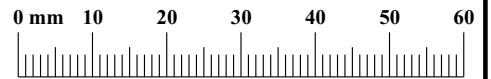
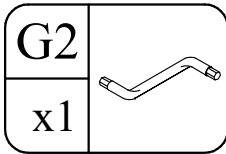
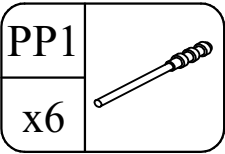
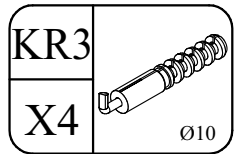
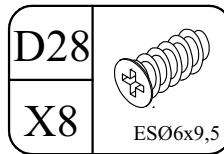
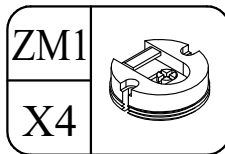
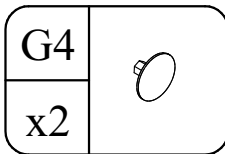
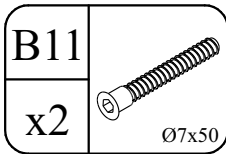
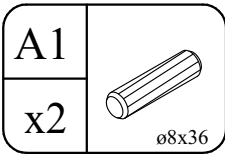

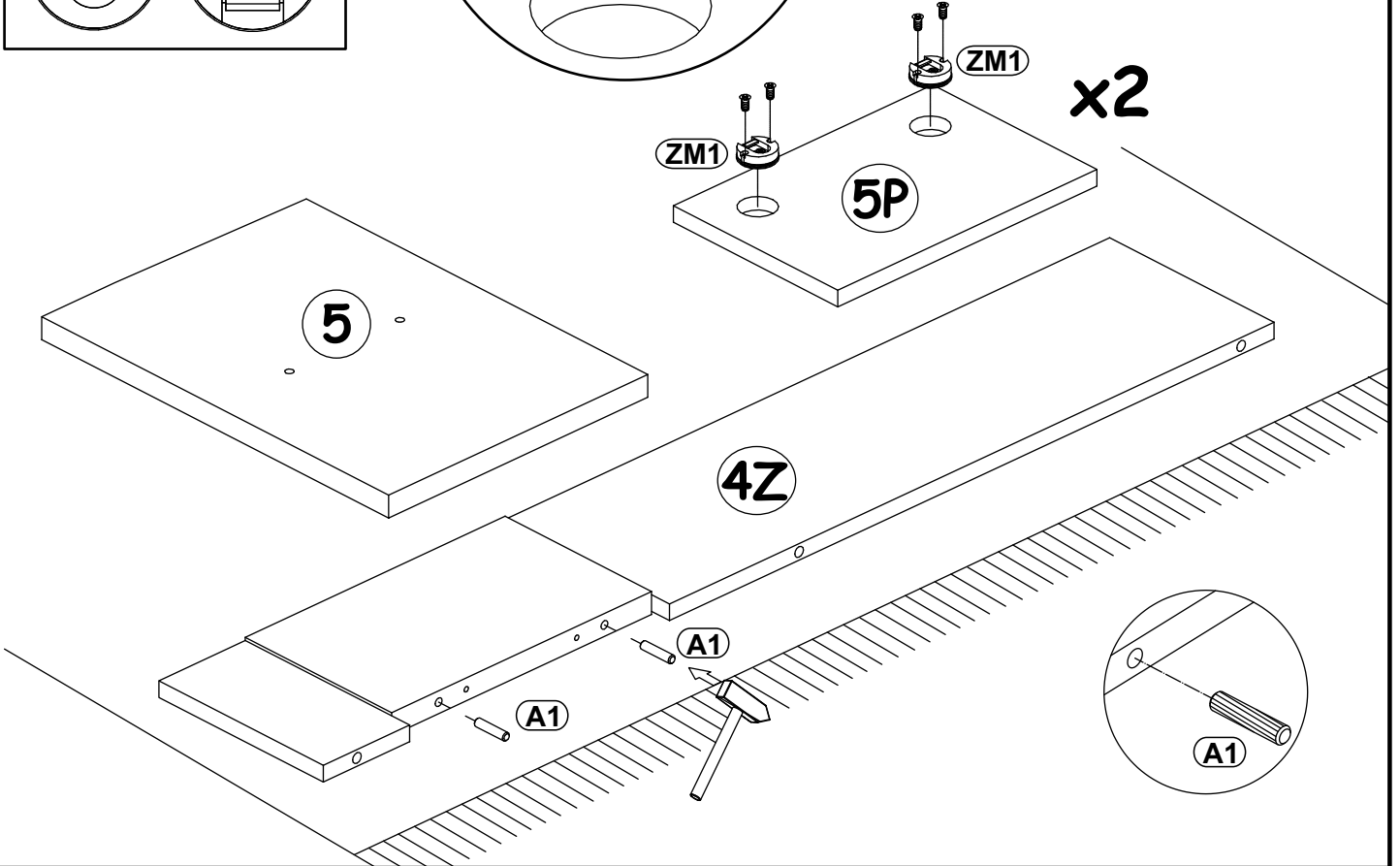
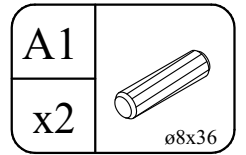
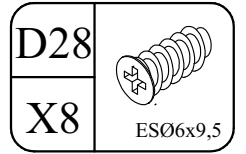
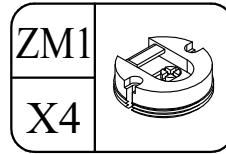
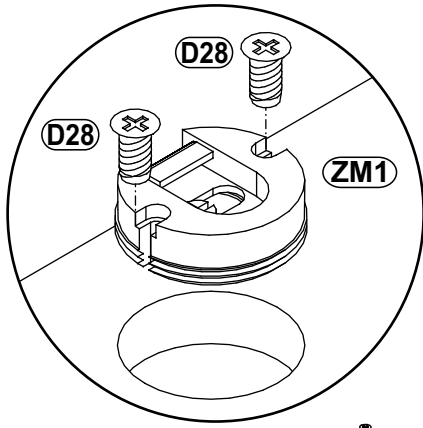
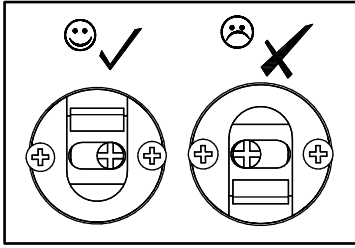

QUILL TYP 70; 71; 72

1

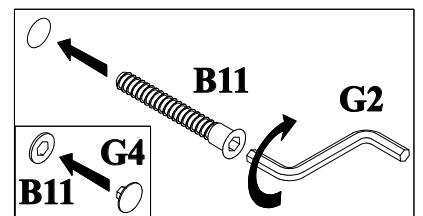
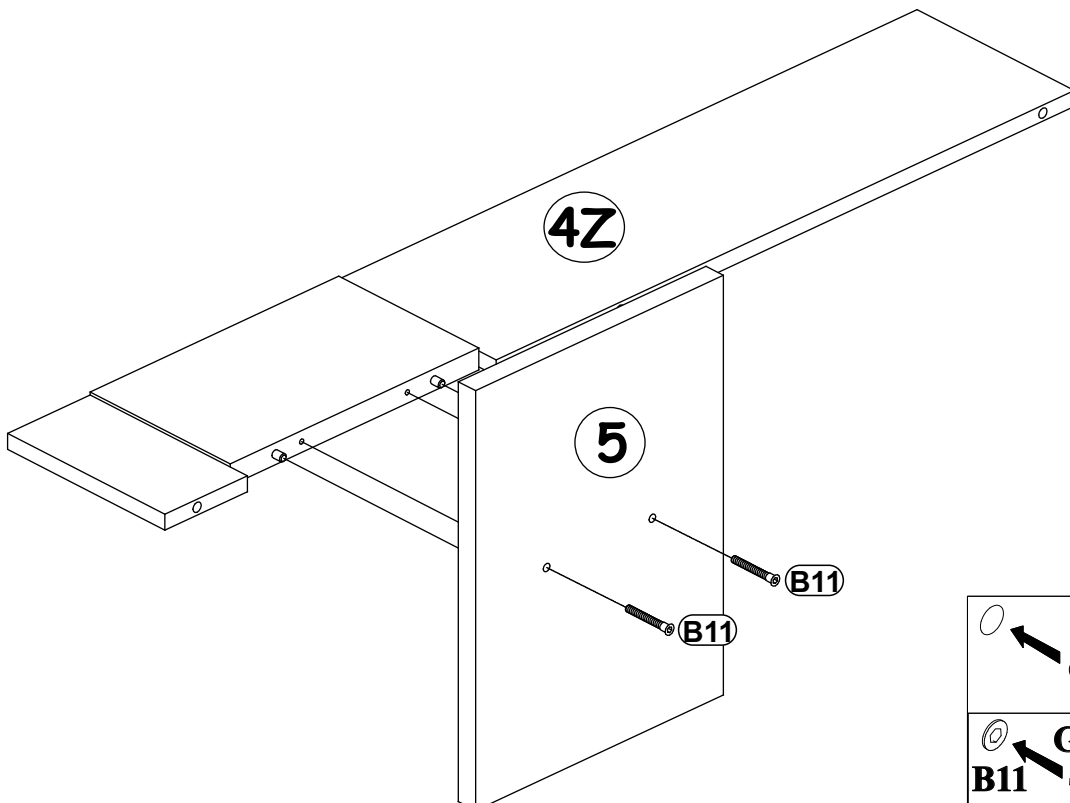
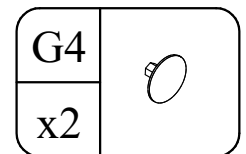
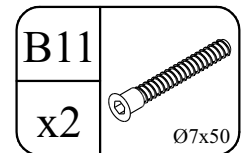

2

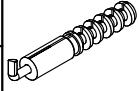

KR3		PP1	
x6	Ø10	x6	

3

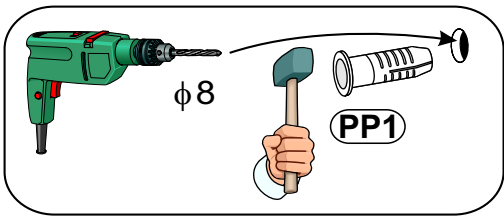
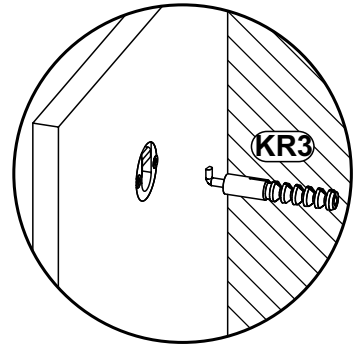
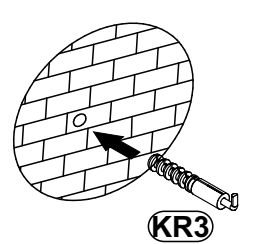
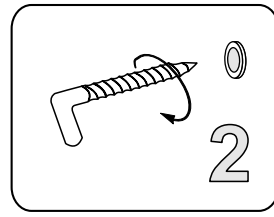
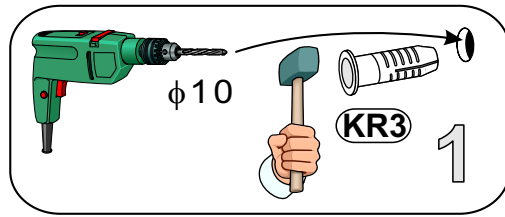
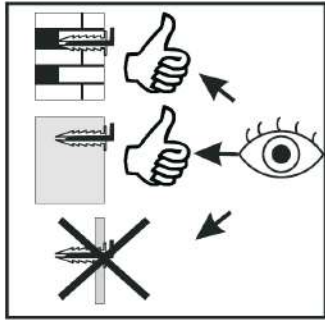

IV

III

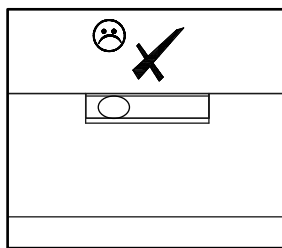
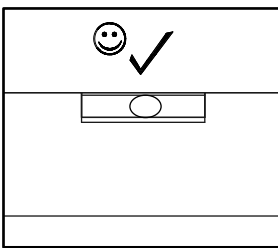
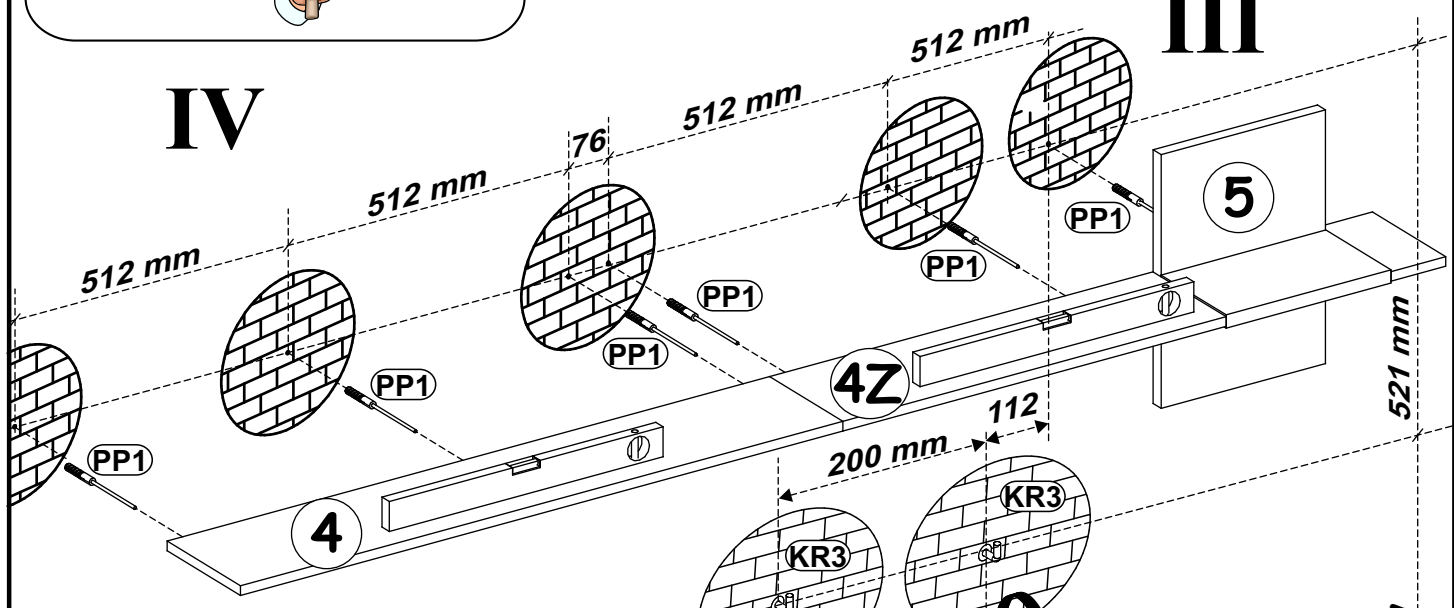

II

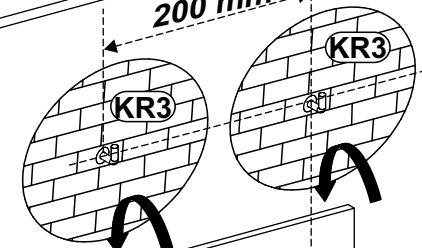

I

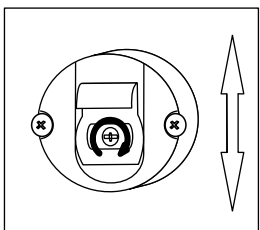
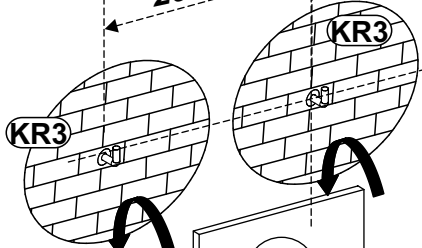

31