

QUILL TYP 20

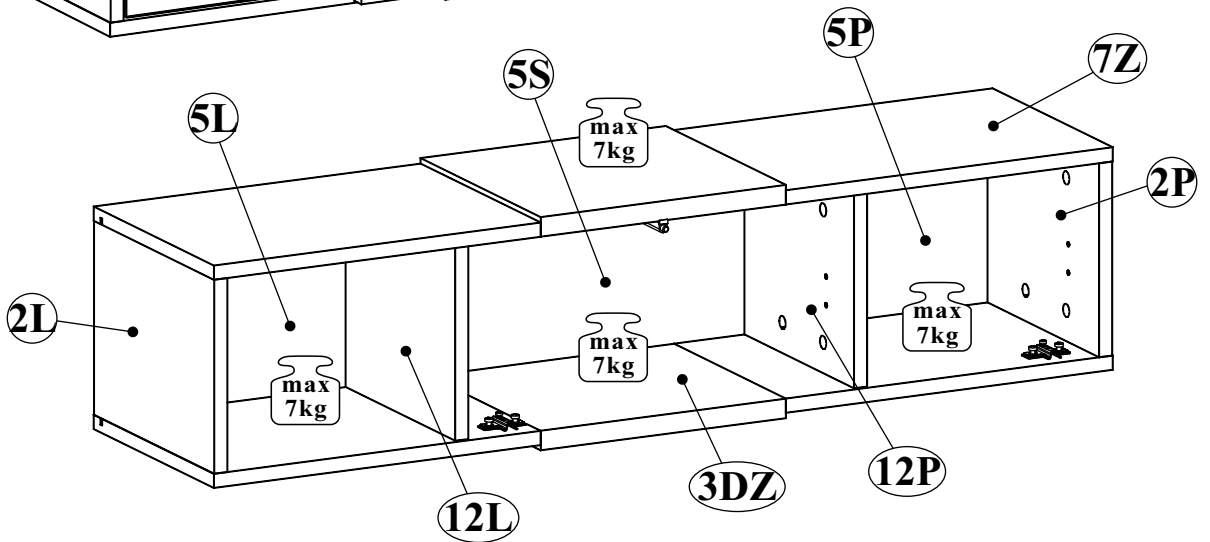

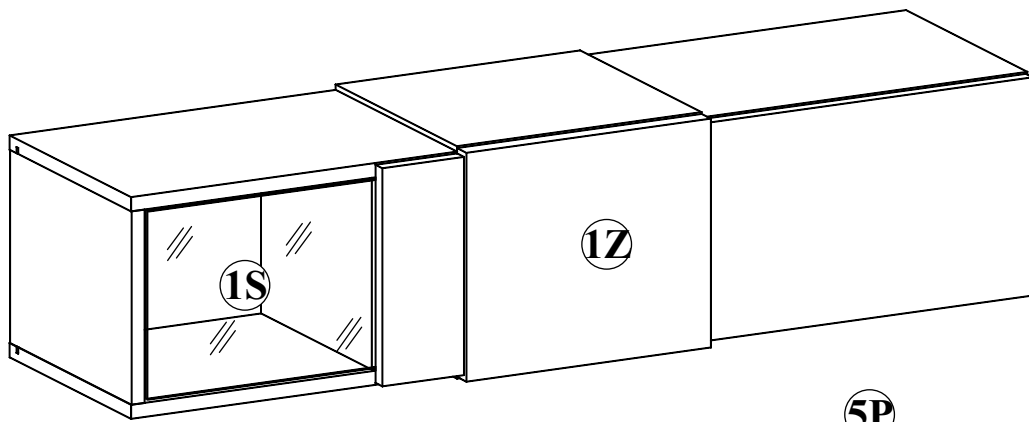

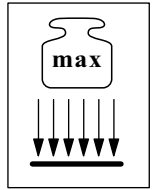

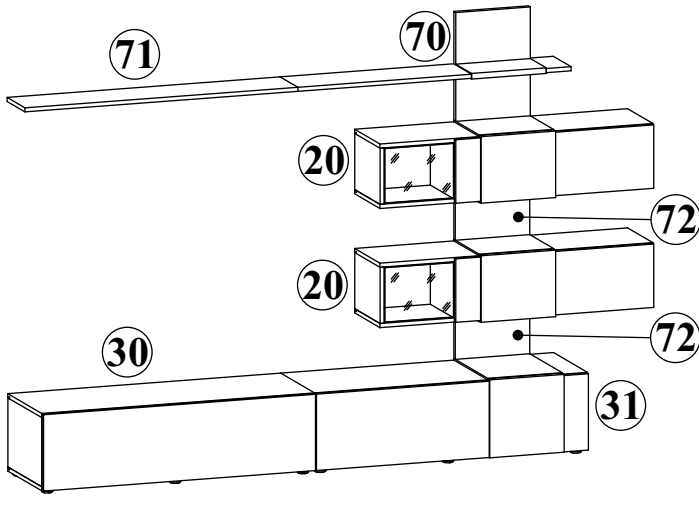
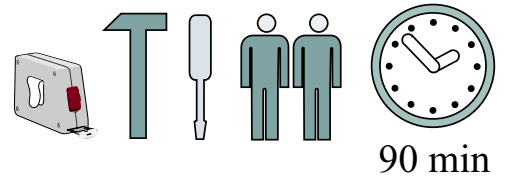



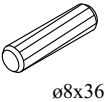
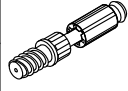

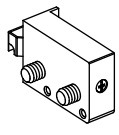
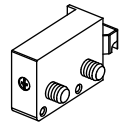
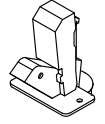
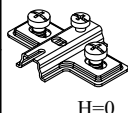
NO	Dim.		Col.-No	Qty
1Z	246	798	16	1
1S	315	212	4	1
2L	218	284	16	1
2P	218	284	16	1
12L	218	259	16	1
12P	218	259	16	1
3DZ	1100	284	16	1
5L	230	295	3	1
5S	230	488	3	1
5P	230	295	3	1
7Z	1100	284	16	1

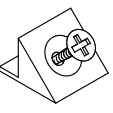
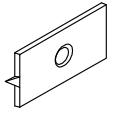

90 min

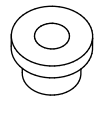
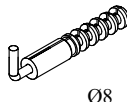
QUILL TYP 20

A1 x16  ø8x36	B4 x16 	B5 x16  Ø15x12	G5 x16 	ZXL x2 	ZXP x2 
E10 x2 	E11 x2  H=0	D10 X10  USØ3,5x13	G21 x2 	D7 x6  USØ3x16	OD2 x1 
S1 x10 	G16 x4 	UP13 x7  UPØ3x16	P2 x3 	KR2 x4  ø8	G2 x1 

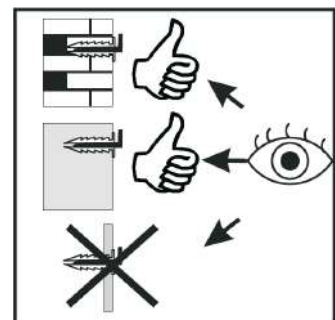
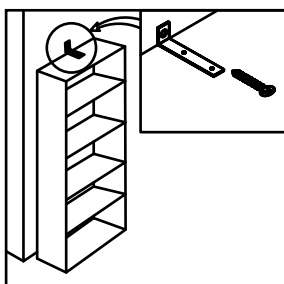
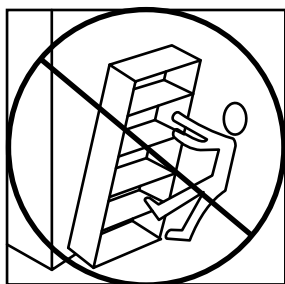
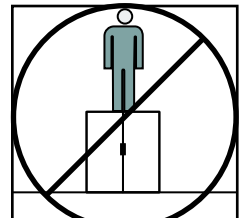
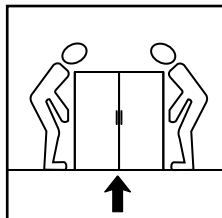
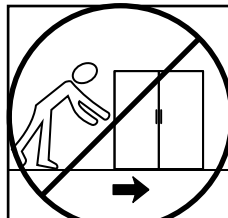
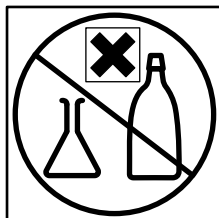
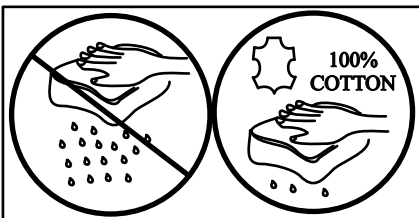
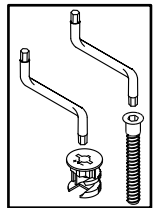
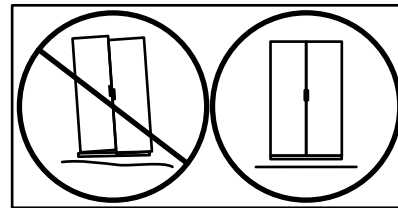
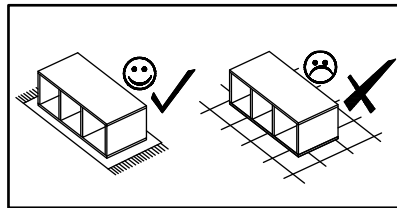
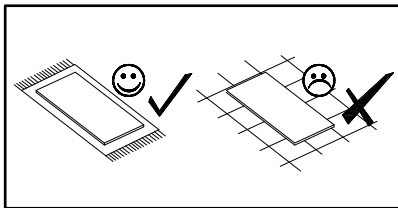
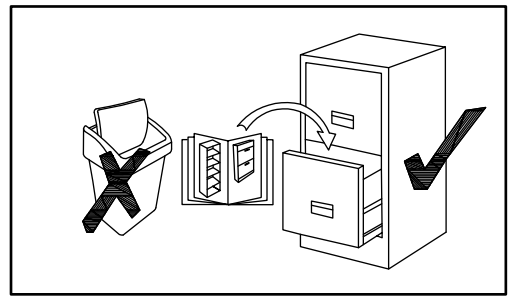
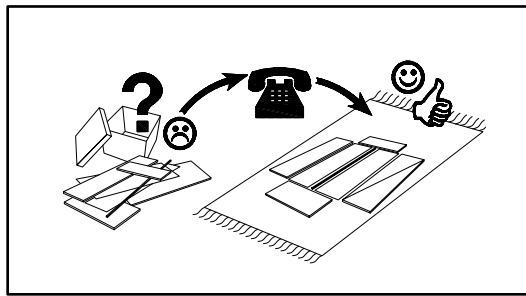
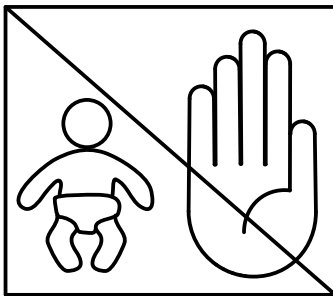
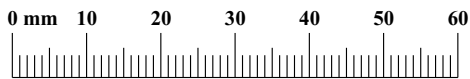

QUILL TYP 20

1

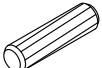
A1	
x16	ø8x36

B5	
x16	Ø15x12

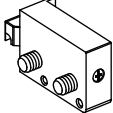
ZXL	
x2	

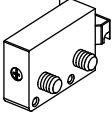
ZXP	
x2	

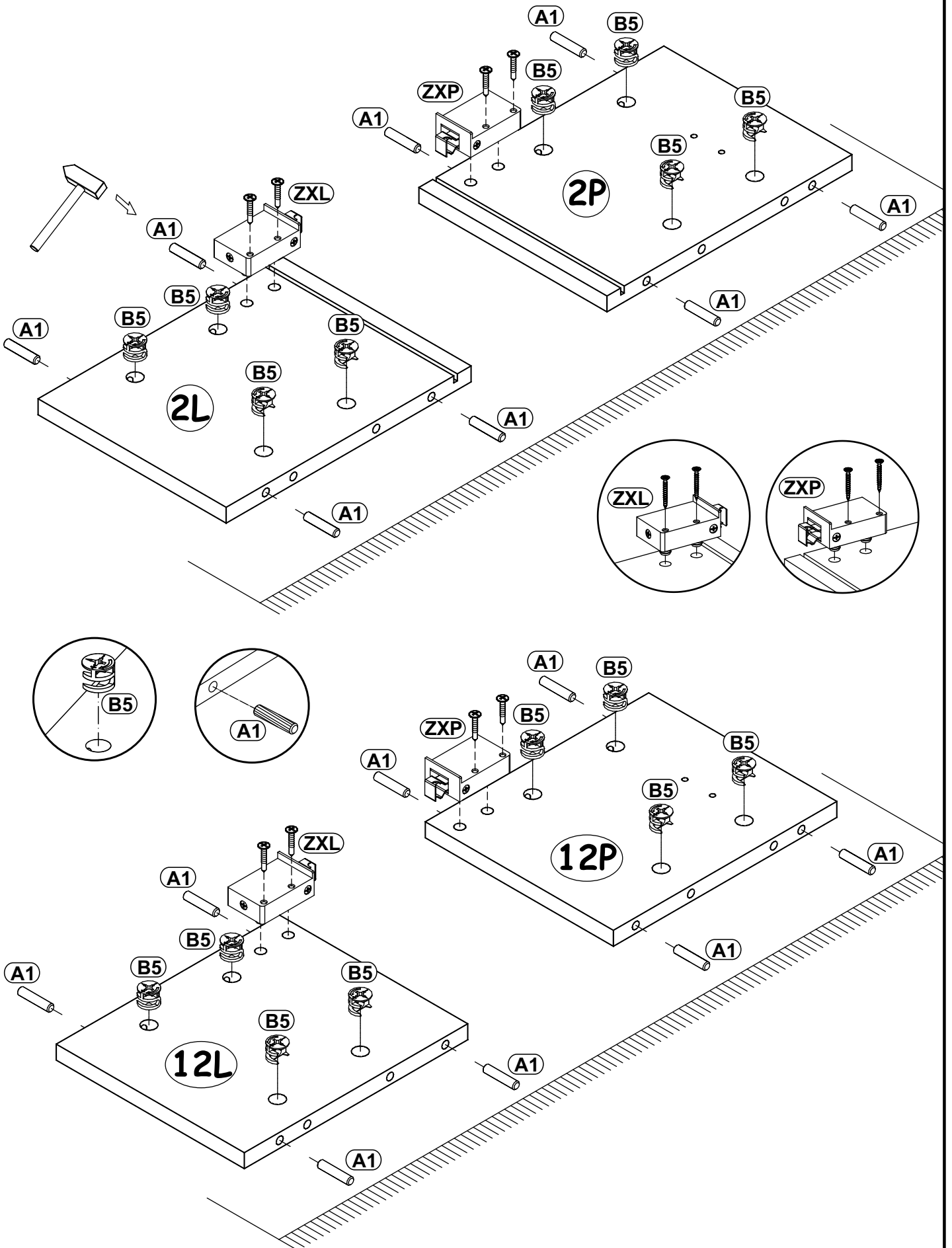

QUILL TYP 20

2

OD2		D10		B4	
x1		x2	USØ3,5x13	x8	

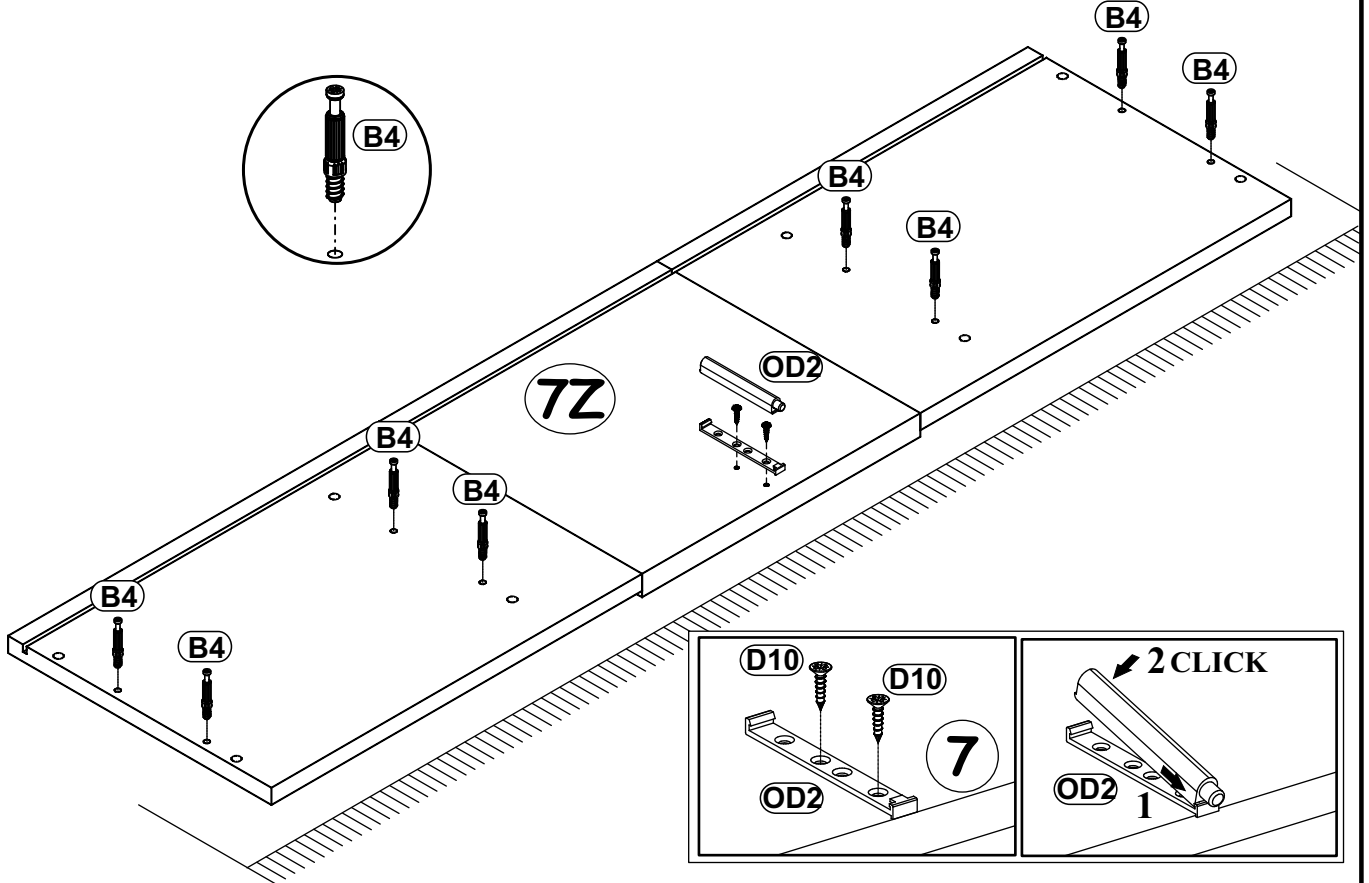

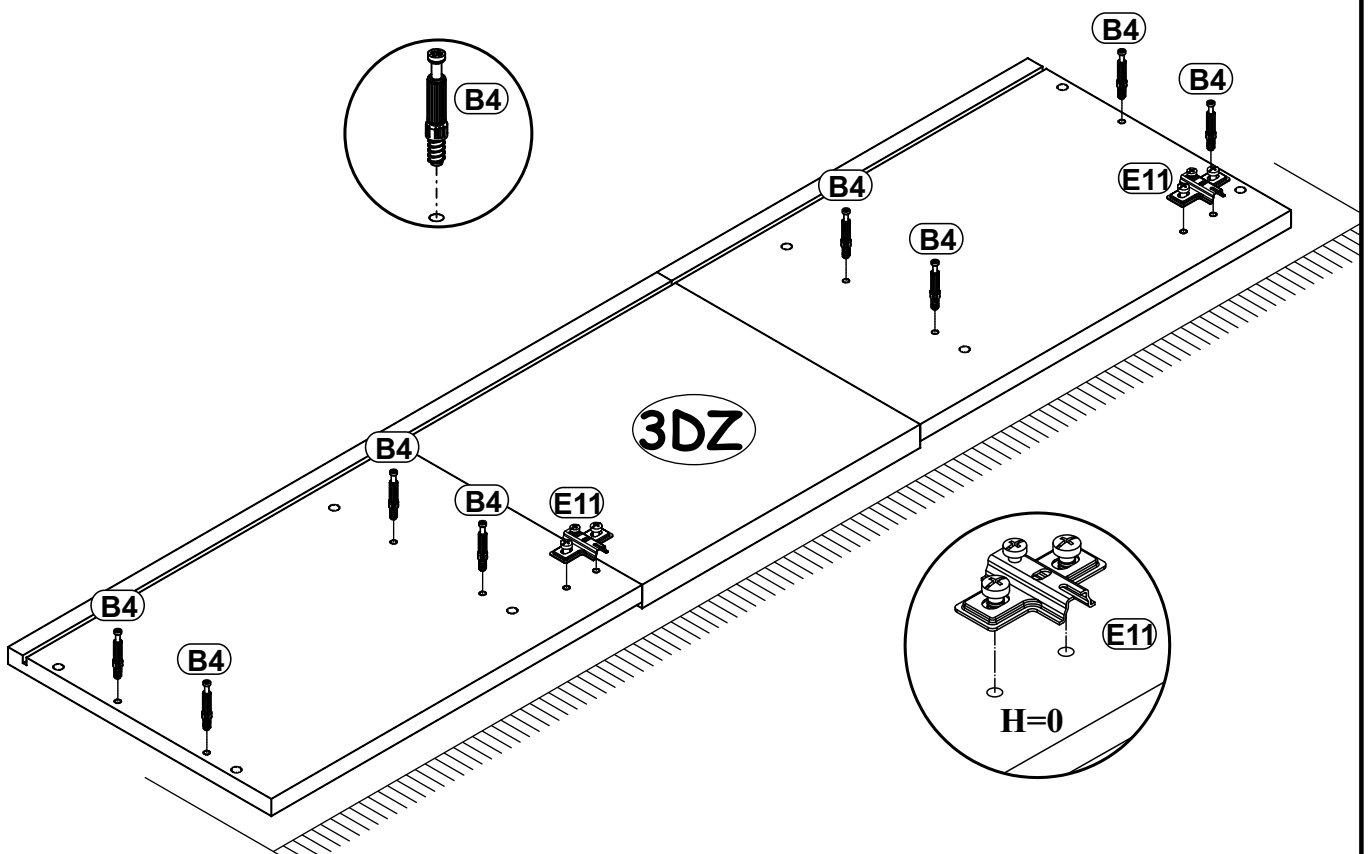

3

B4		E11	
x8		x2	H=0

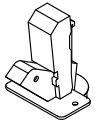
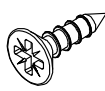

QUILL TYP 20

4

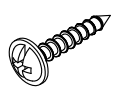
E10		D10		P2		UP13	
x2		x4	USØ3,5x13	x3		x3	UPØ3x16

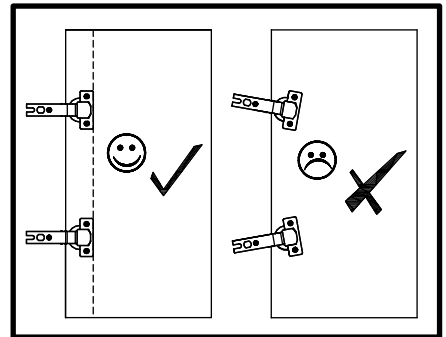
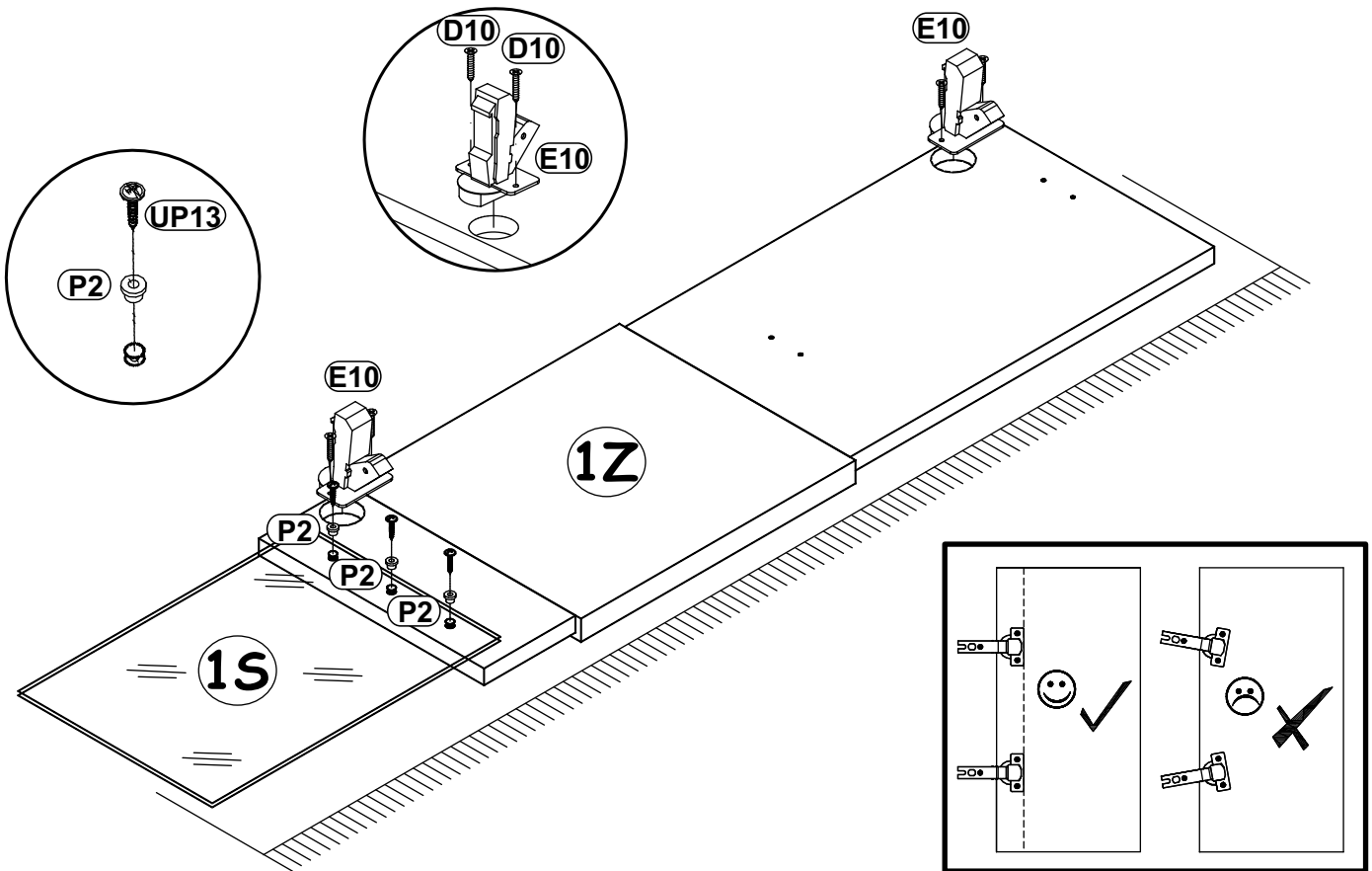

5

G5	
x8	

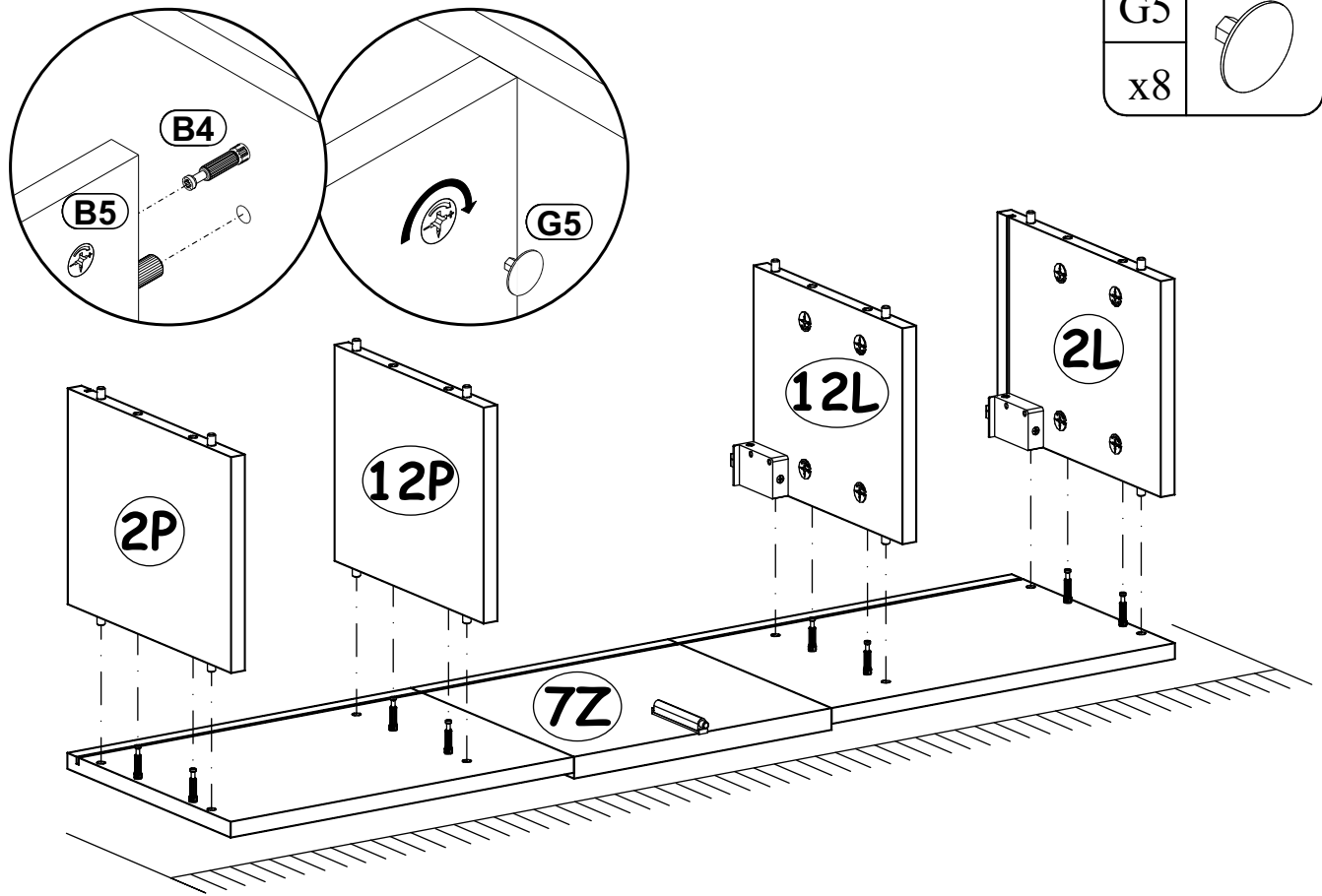

6

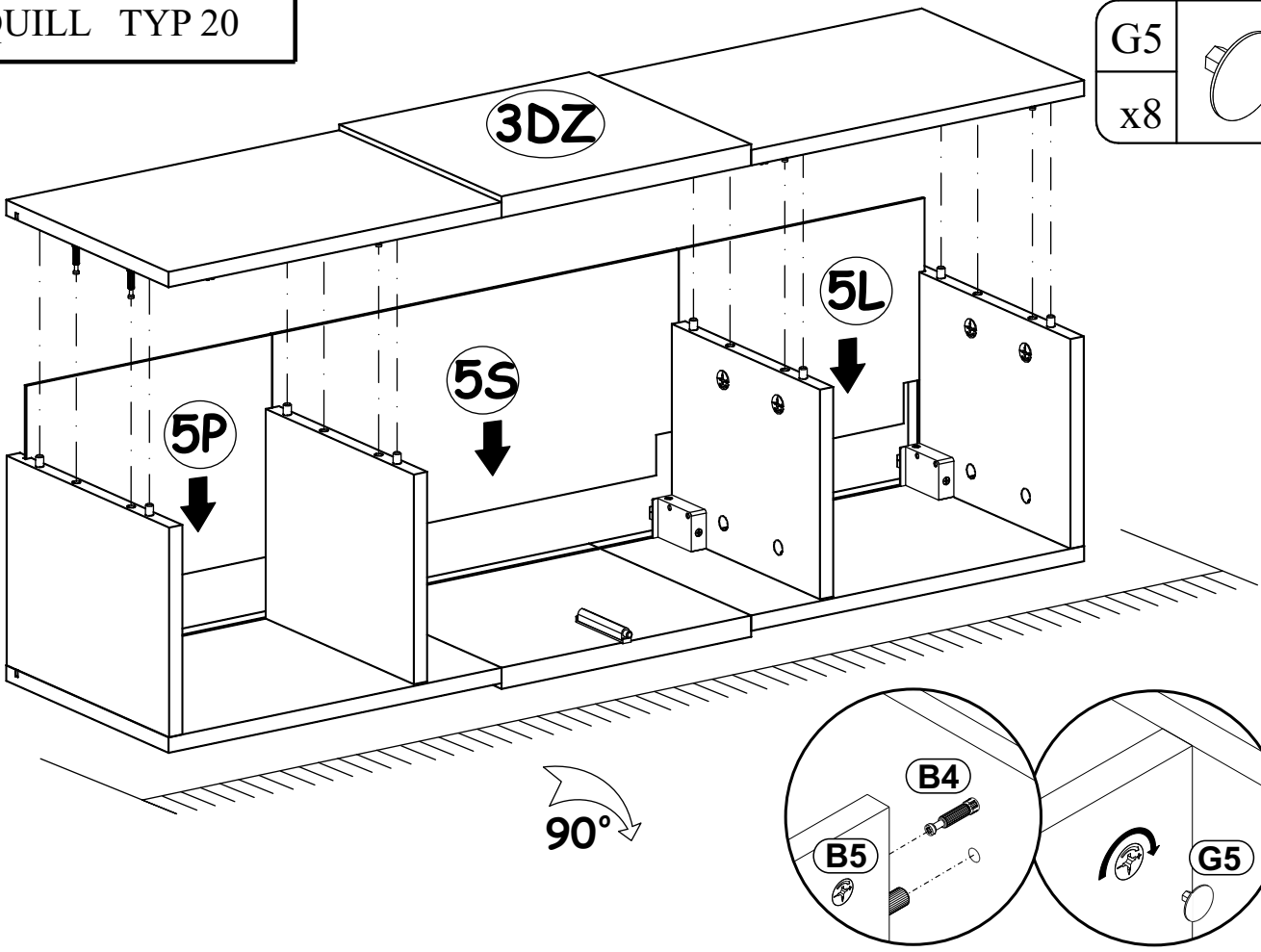

G5	
x8	

7

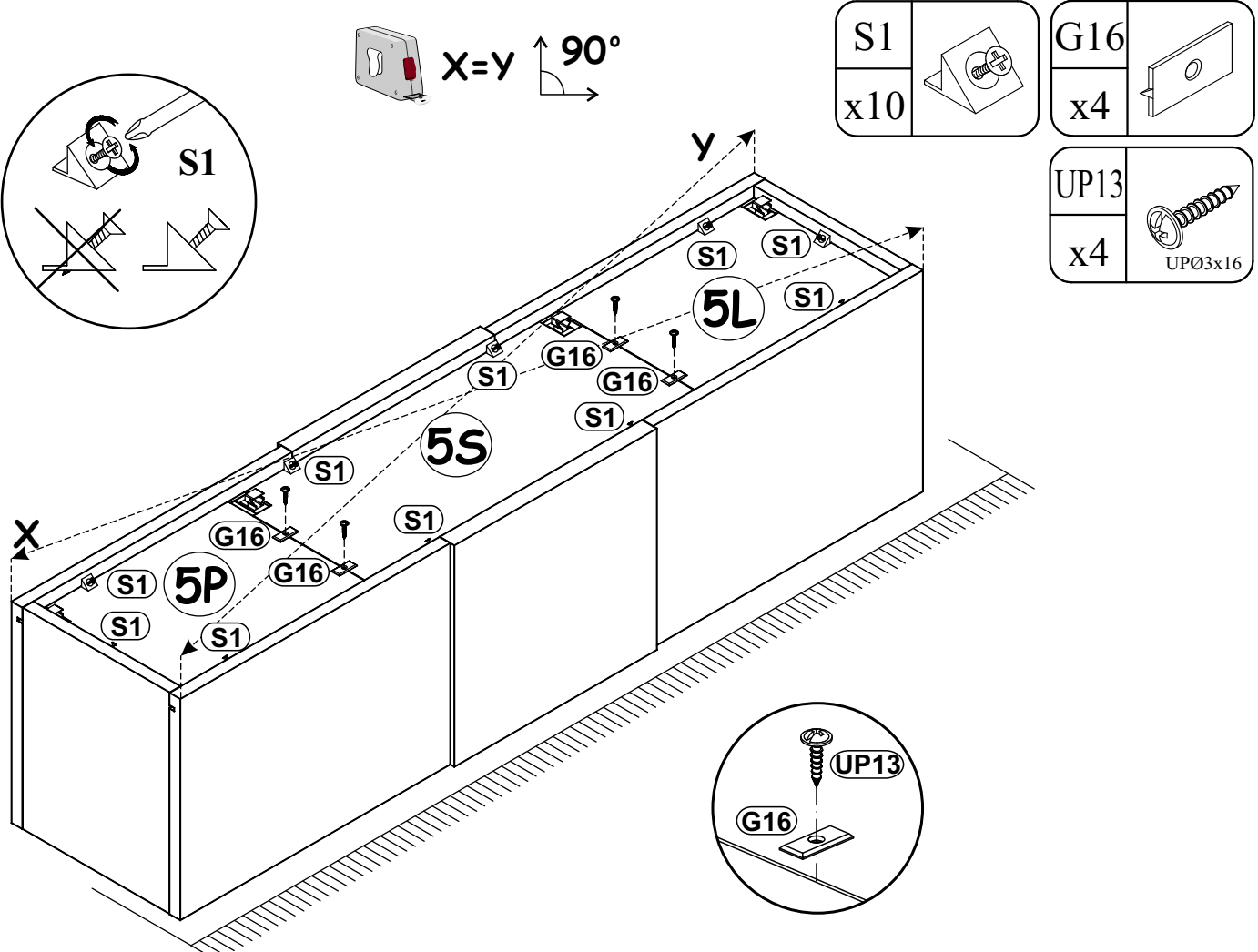

S1	
x10	

G16	
x4	

UP13	
x4	UPØ3x16

QUILL TYP 20

8

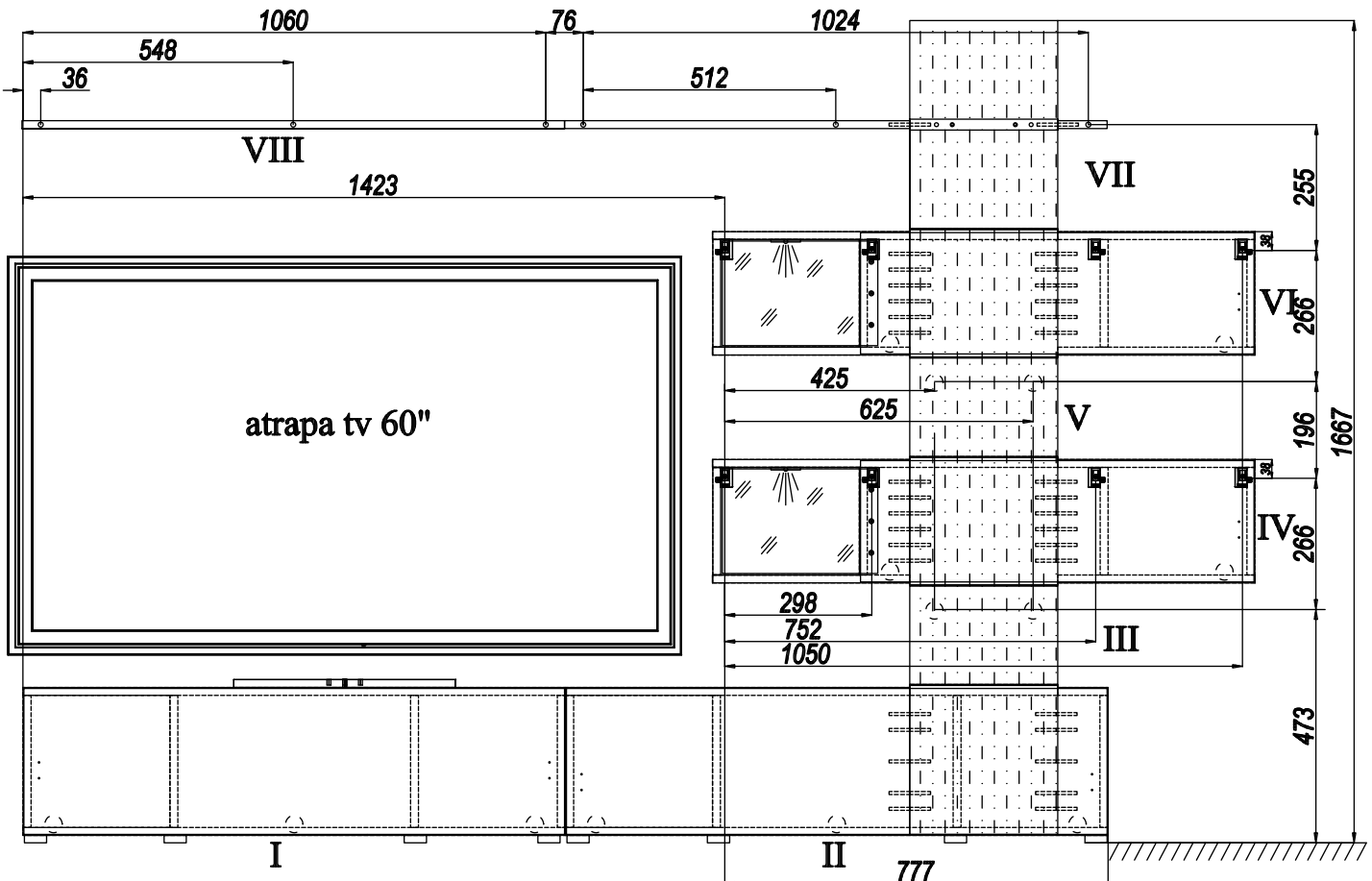
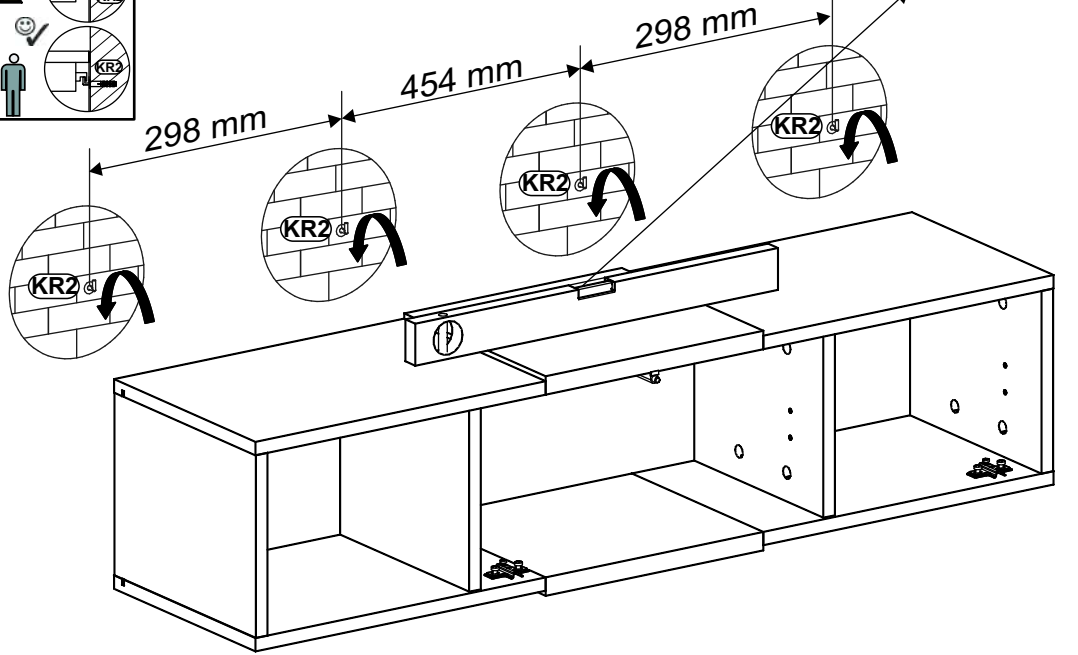
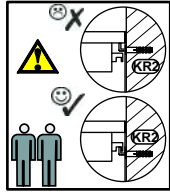
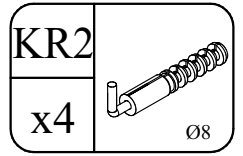
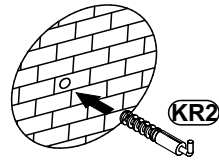
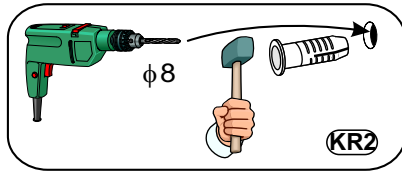
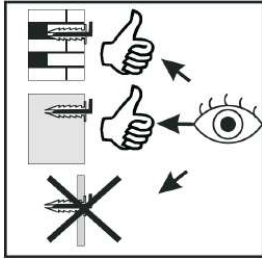

QUILL TYP 20

9

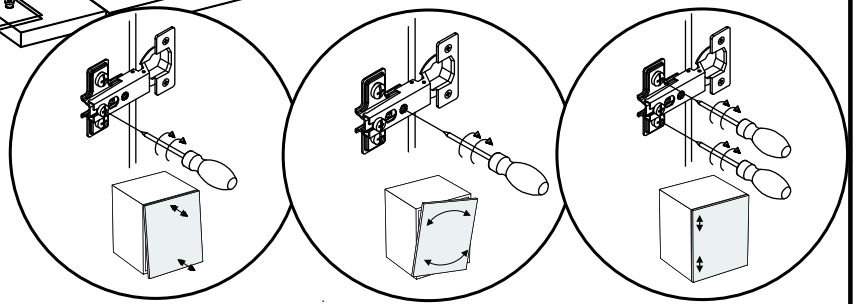
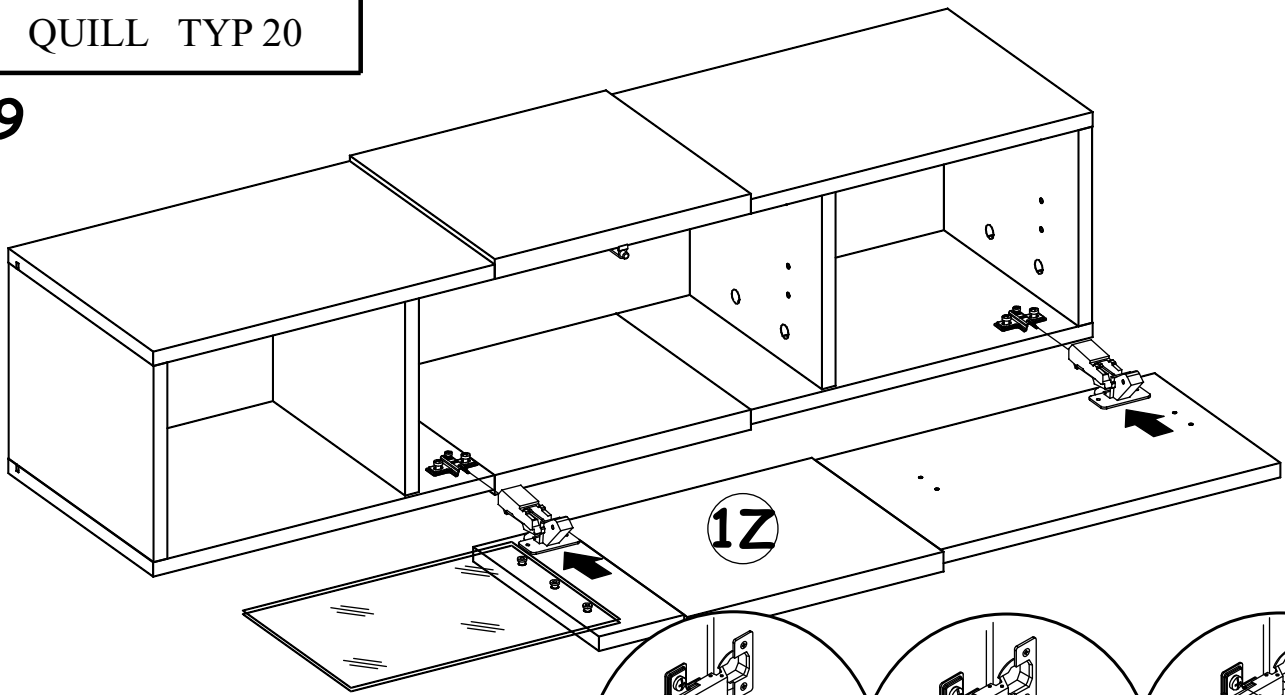

10

G21		D7		D10	
x2		x6	USØ3x16	X4	USØ3,5x13

