

# RIO

## Półki

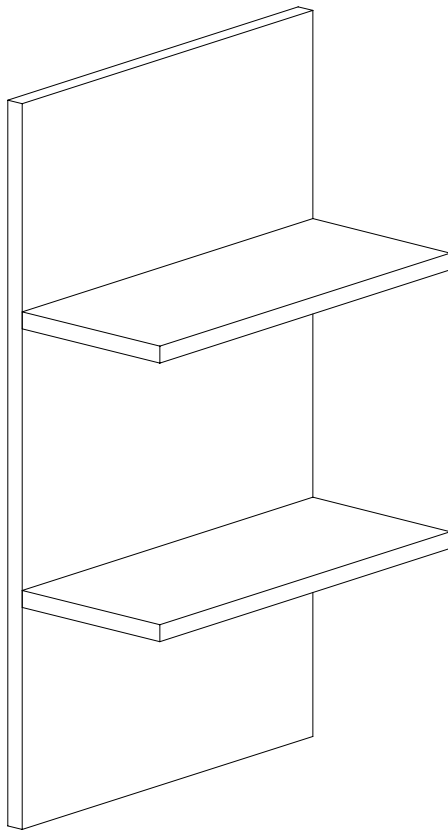

PL

Instrukcja montażu

D

Montageanleitung

GB

Assembly instructions

NL

Handleiding voor de montage

ES

Instrucciones de instalación

F

Instructions d'installation

# Półka

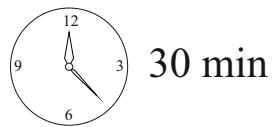

# 1/3

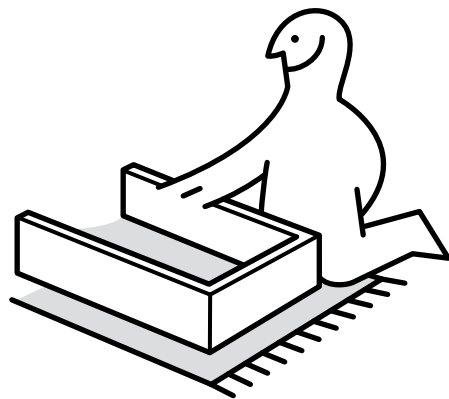
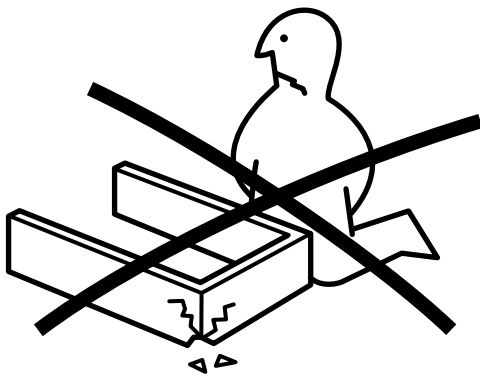
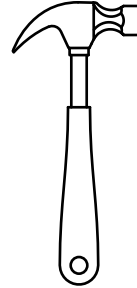
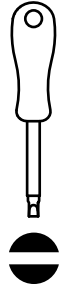

# Półka



30 min

# 2/3

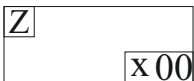
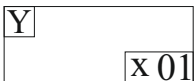
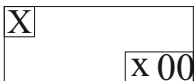
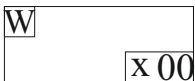
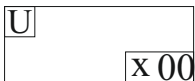
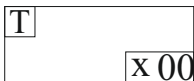
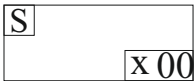
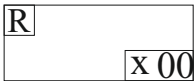
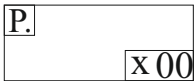
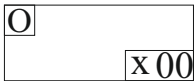
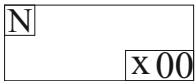
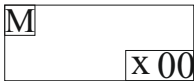
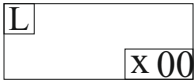
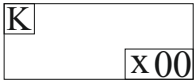
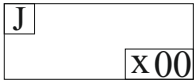
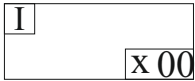
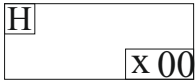
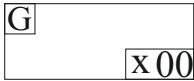
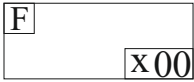
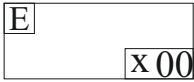
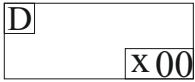
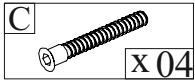
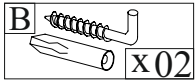
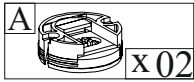
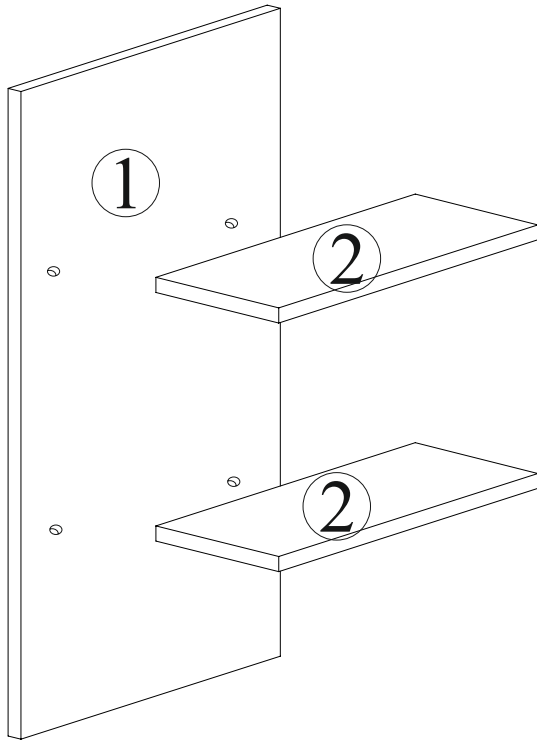

# 1

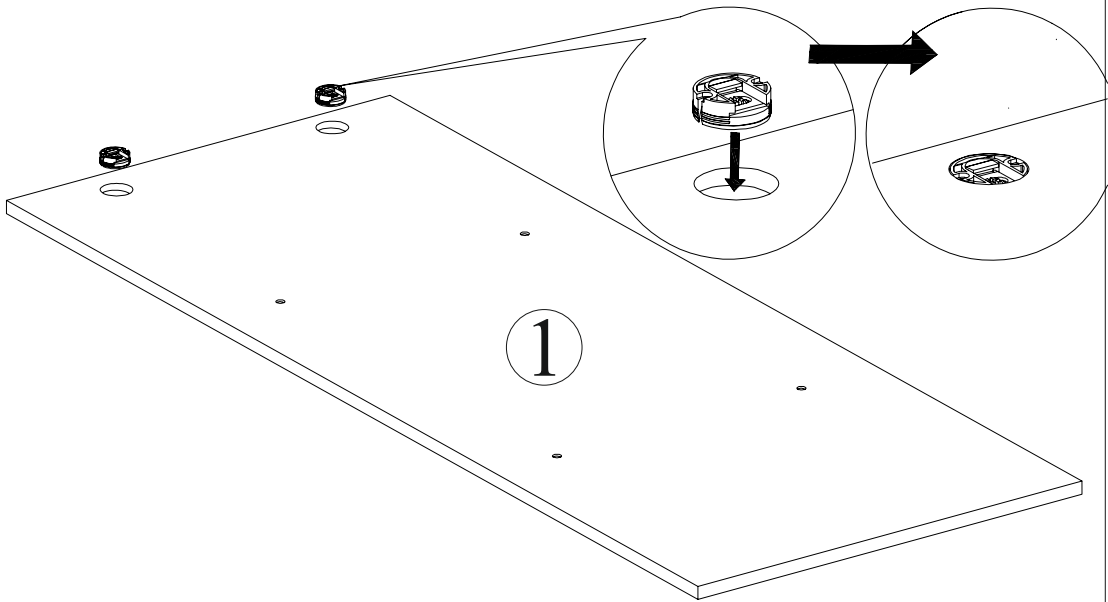
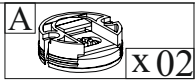

# Półka



30 min

# 3/3

## 2

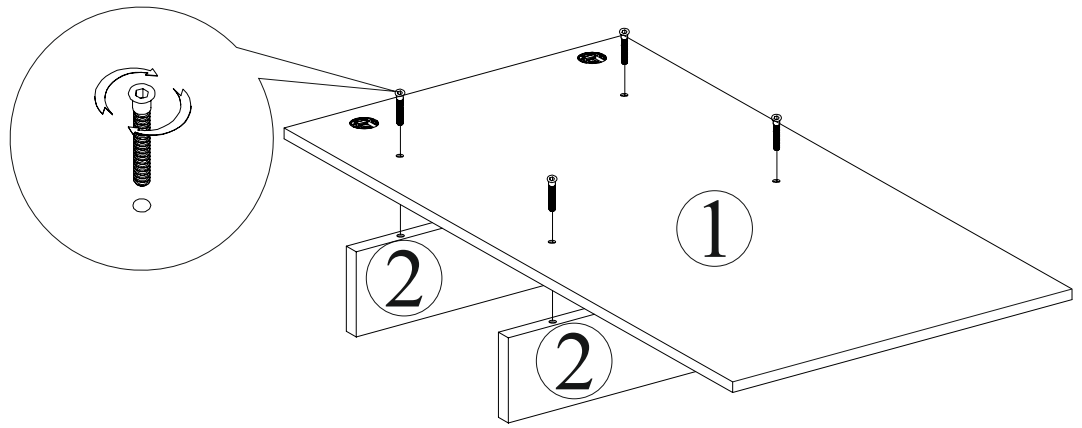
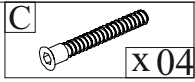

## 3

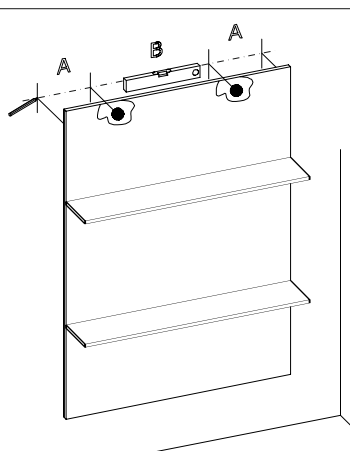

## 4

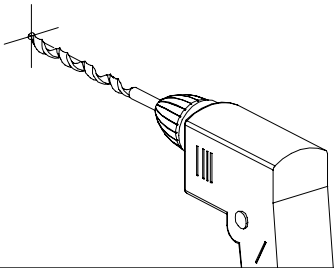

## 5

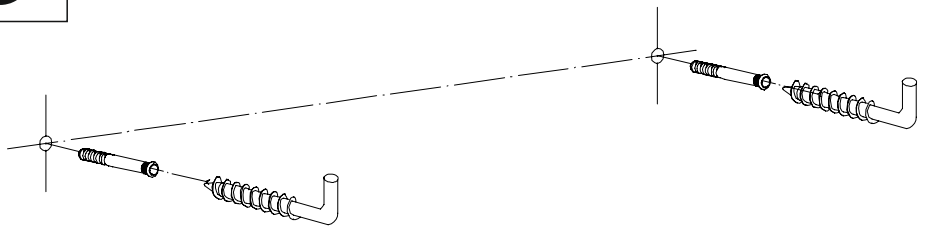
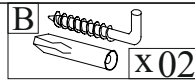

## 6

