

P

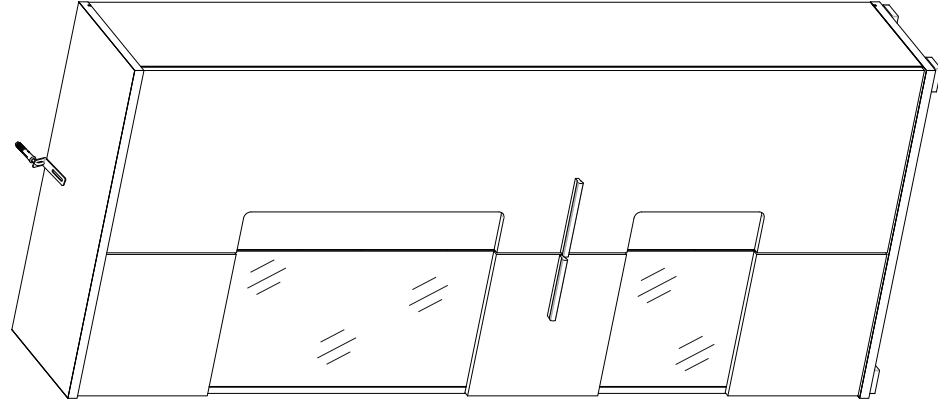

120 min

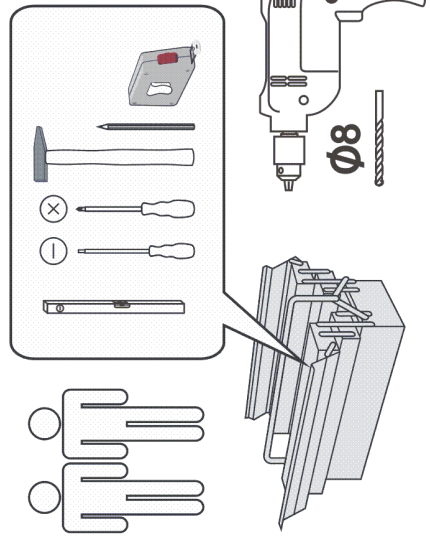

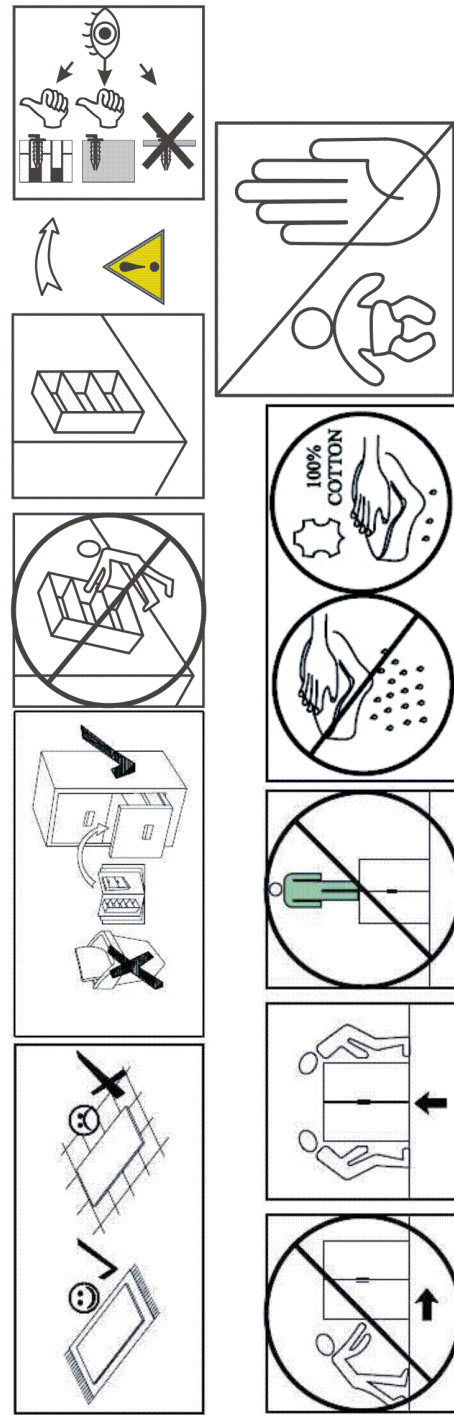
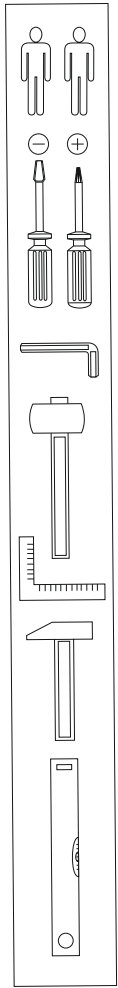

P

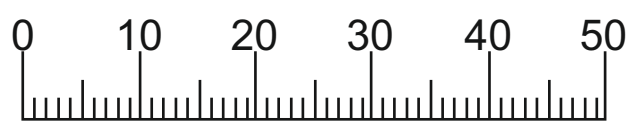
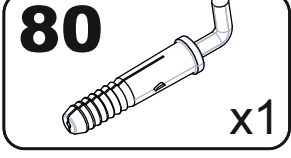
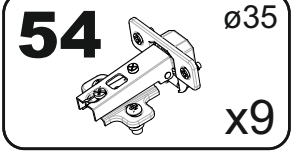
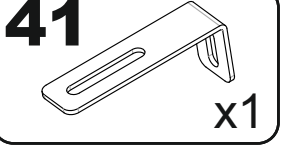
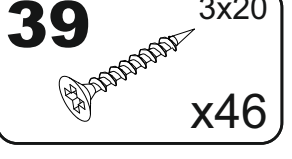
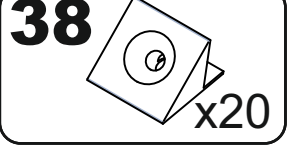
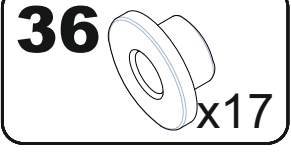
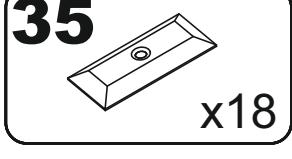
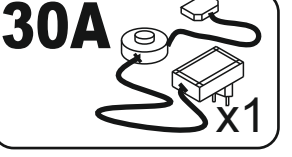
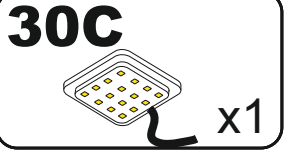
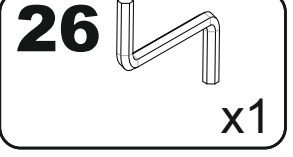
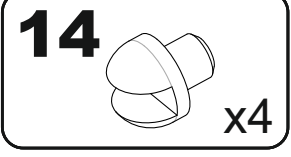
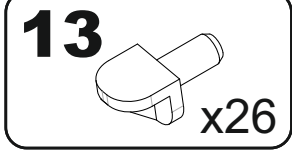
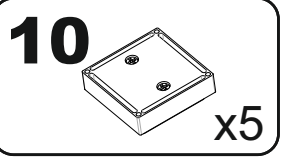
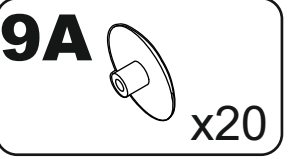
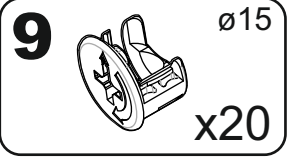
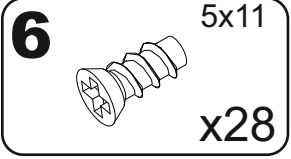
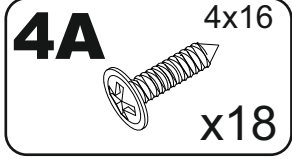
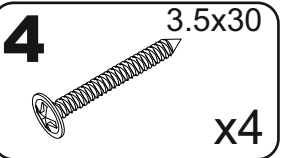
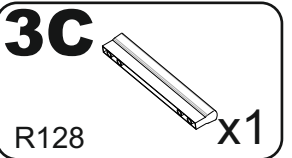
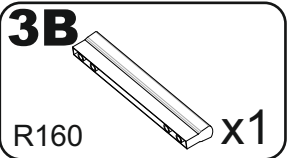
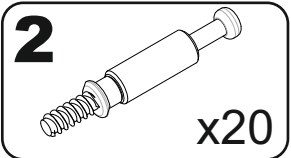
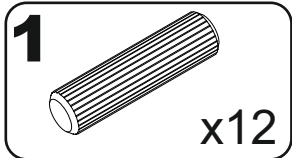
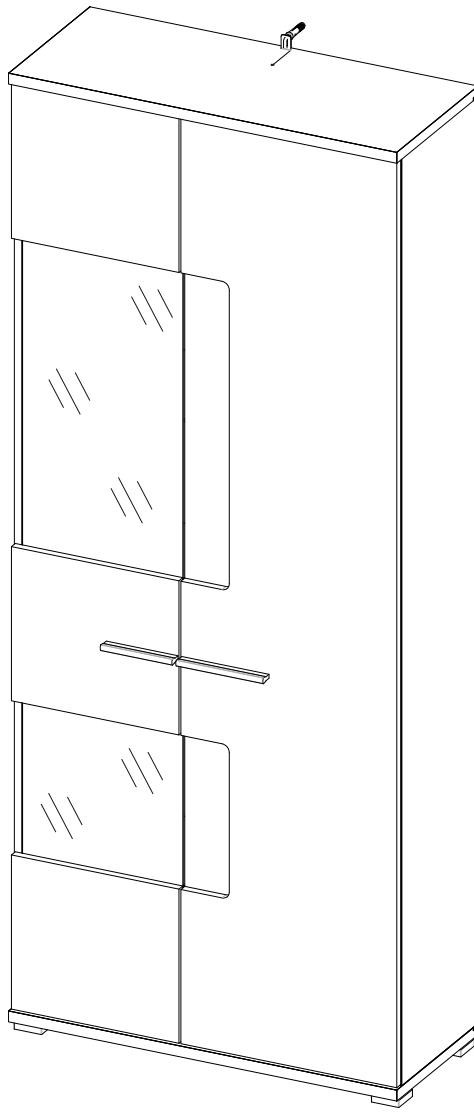

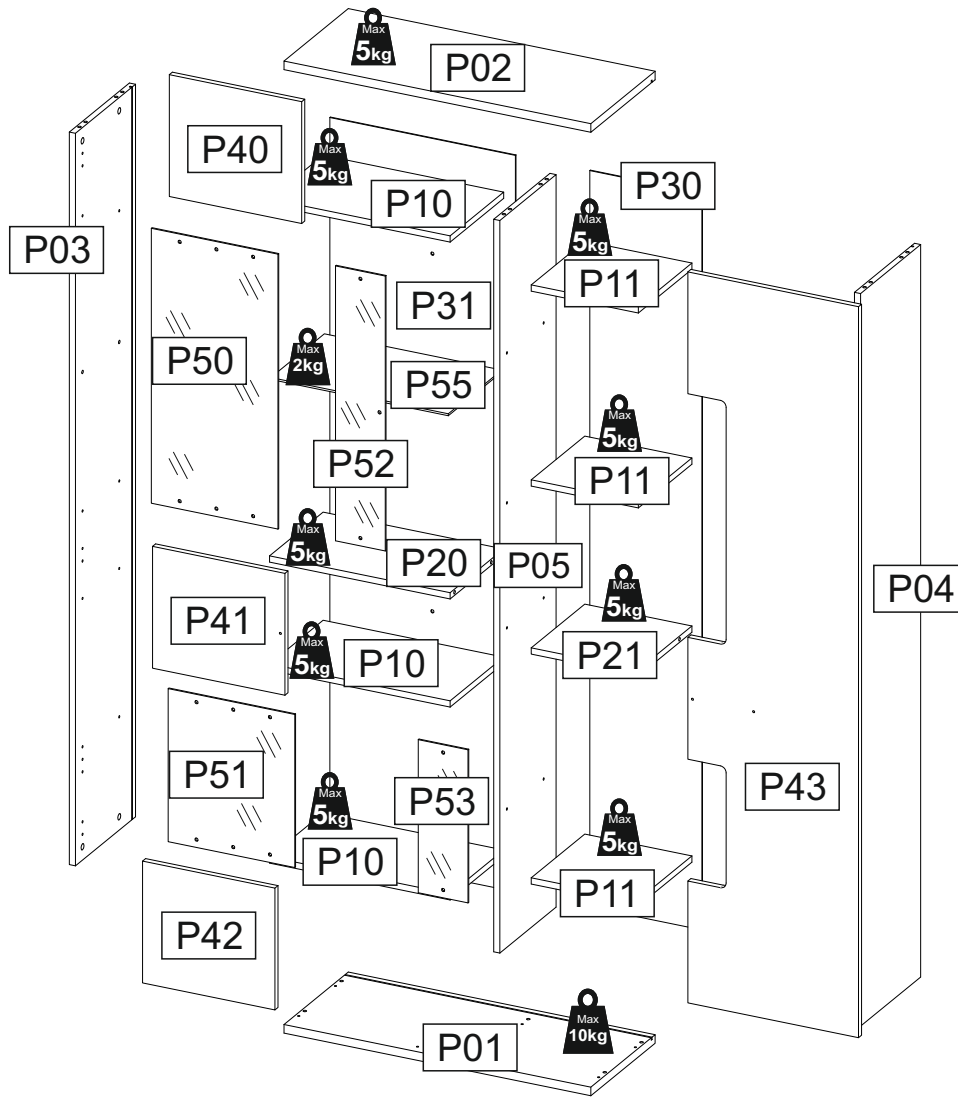

A	B (mm)	C (mm)	D (mm)	E	F
P01	802	336	22	1	1 2
P02	802	336	22	1	1 2
P03	1876	314	16	1	2 2
P04	1876	314	16	1	2 2
P05	1876	294	16	1	2 2
P10	472	280	16	3	1 2
P11	280	280	16	3	1 2
P20	472	280	16	1	1 2
P21	280	280	16	1	1 2
P30	1886	485	3	1	2 2
P31	1886	293	3	1	2 2
P40	312	346	16	1	1 2
P41	312	346	16	1	1 2
P42	312	346	16	1	1 2
P43	1872	446	16	1	2 2
P50	704	331	4	1	2 2
P51	392	331	4	1	2 2
P52	704	130	4	1	2 2
P53	392	130	4	1	2 2
P55	464	280	5	1	1 2

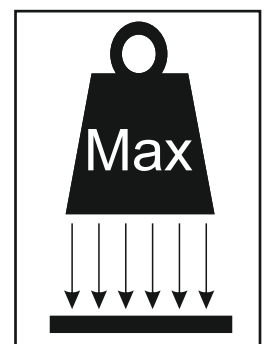
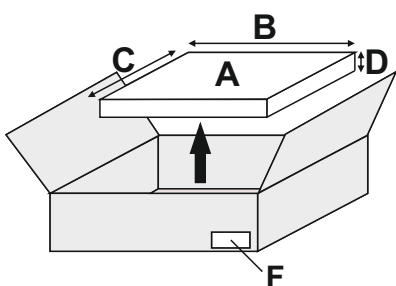

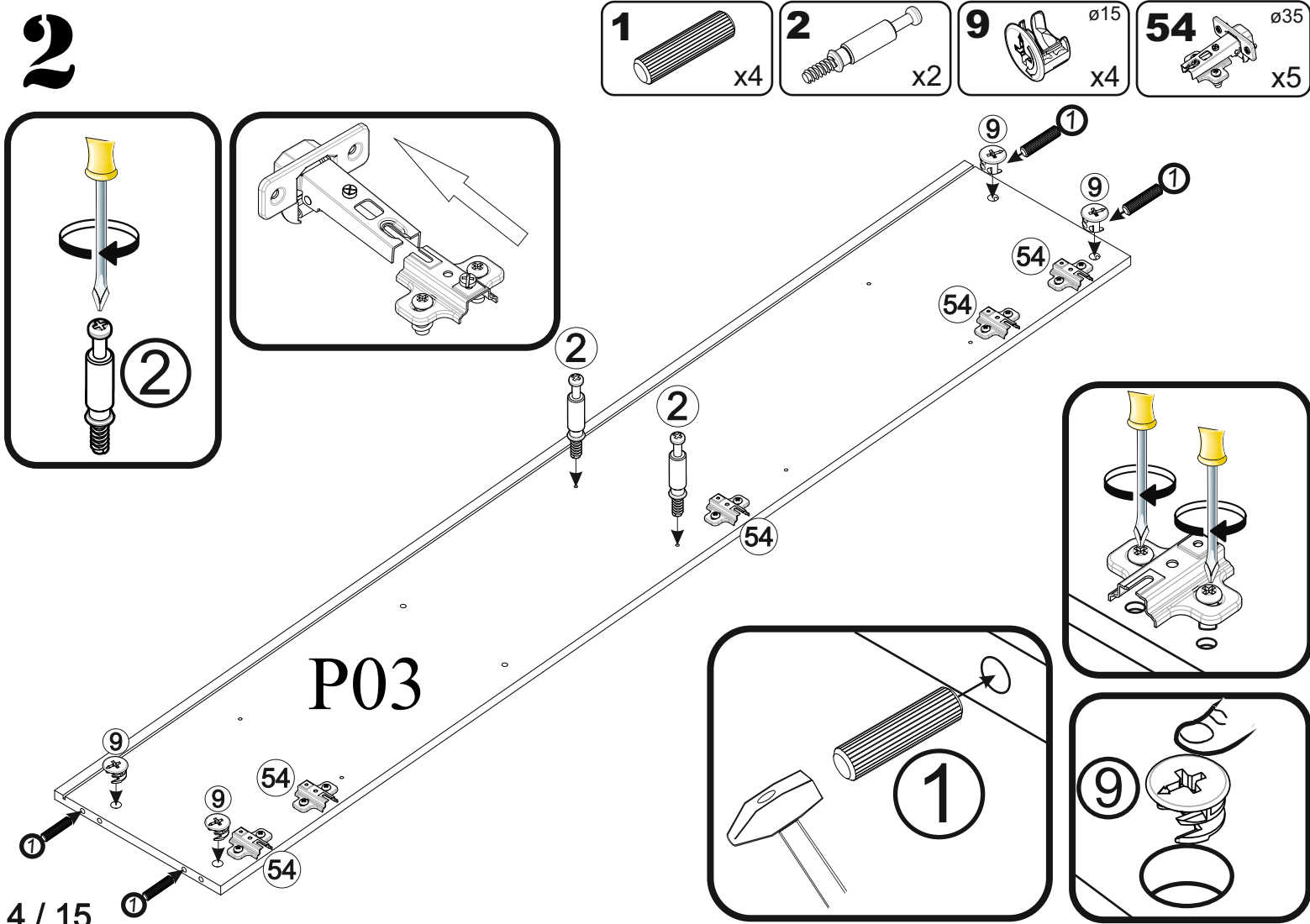
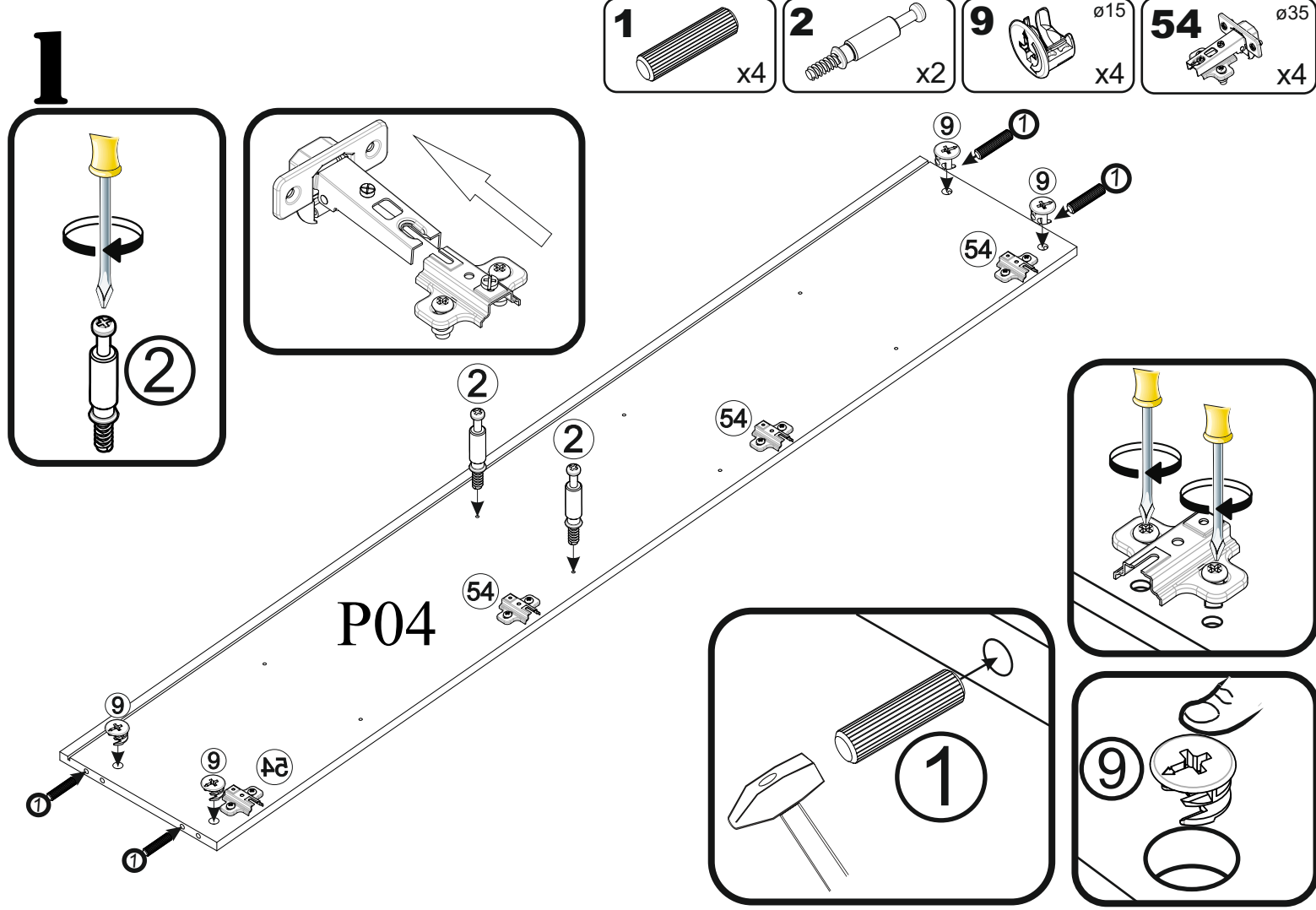

3

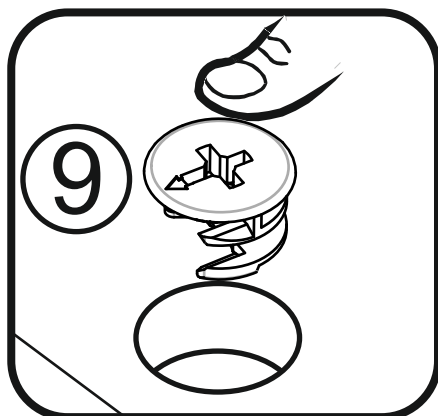
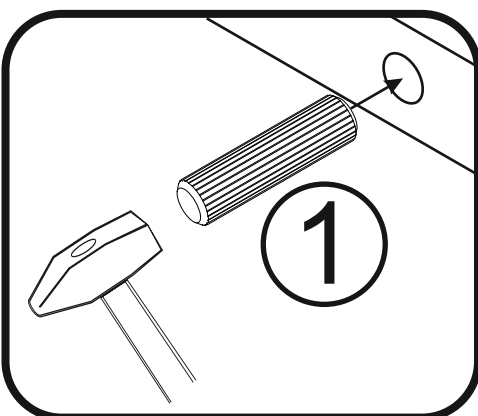
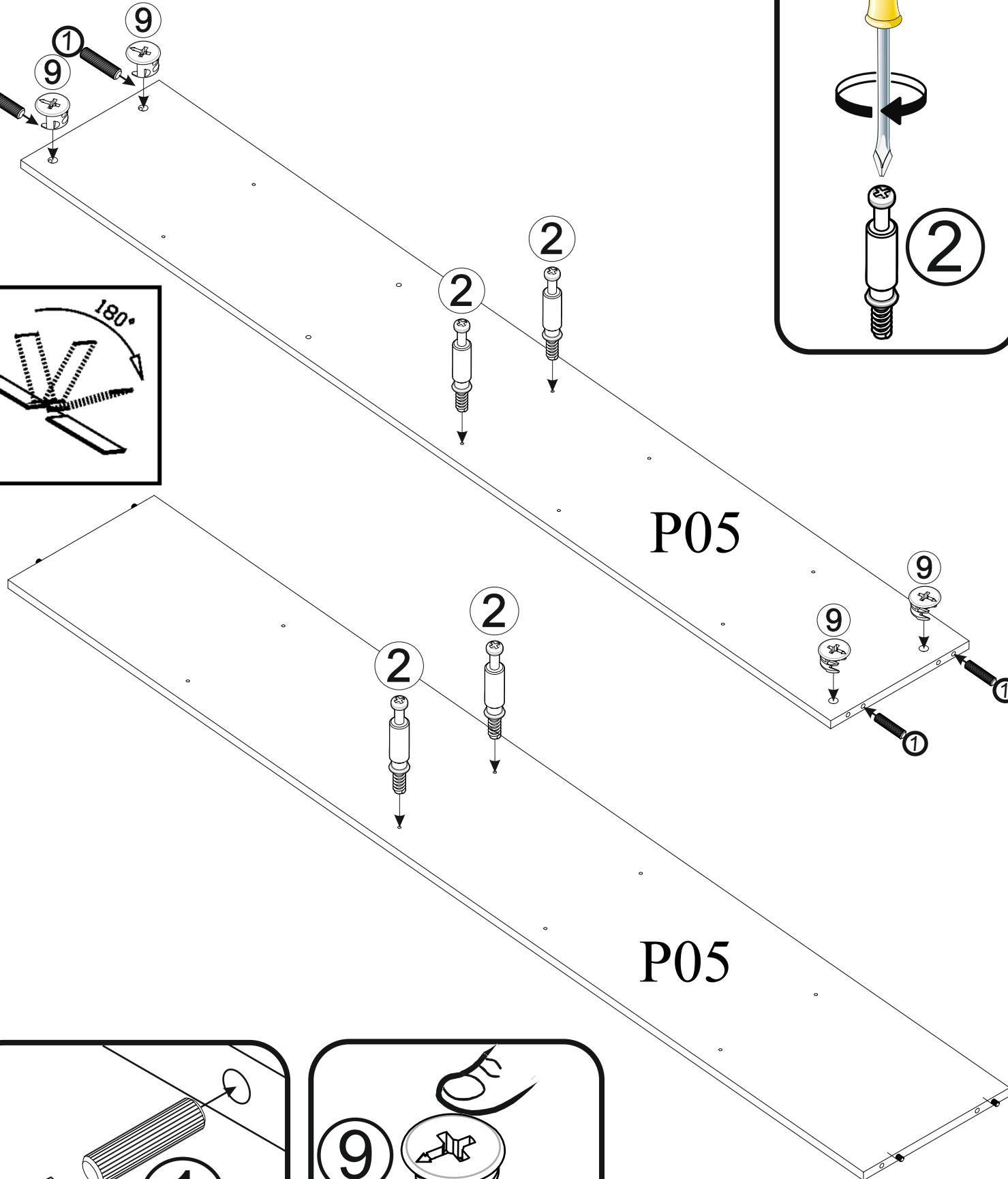
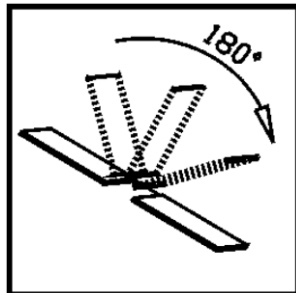
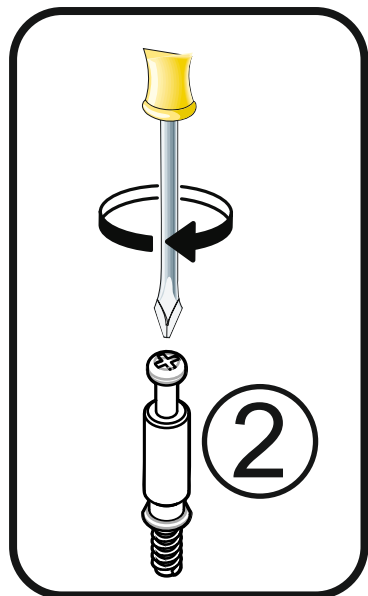
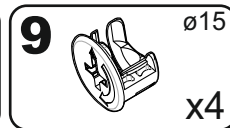
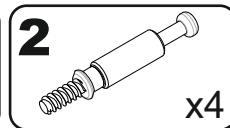
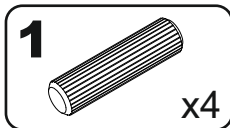

4

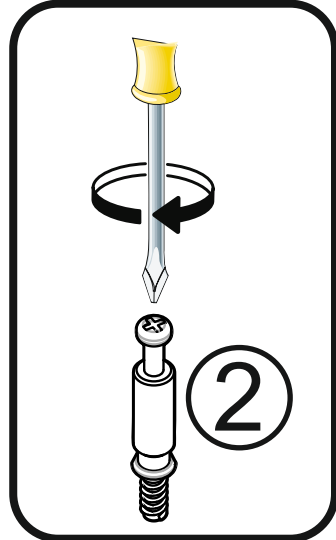
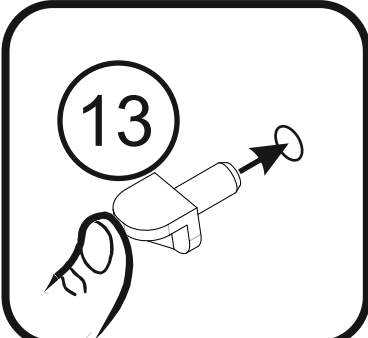
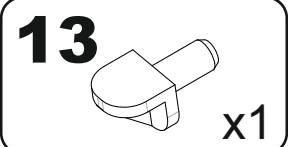
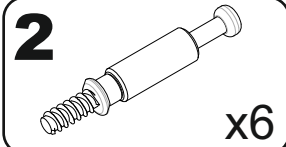
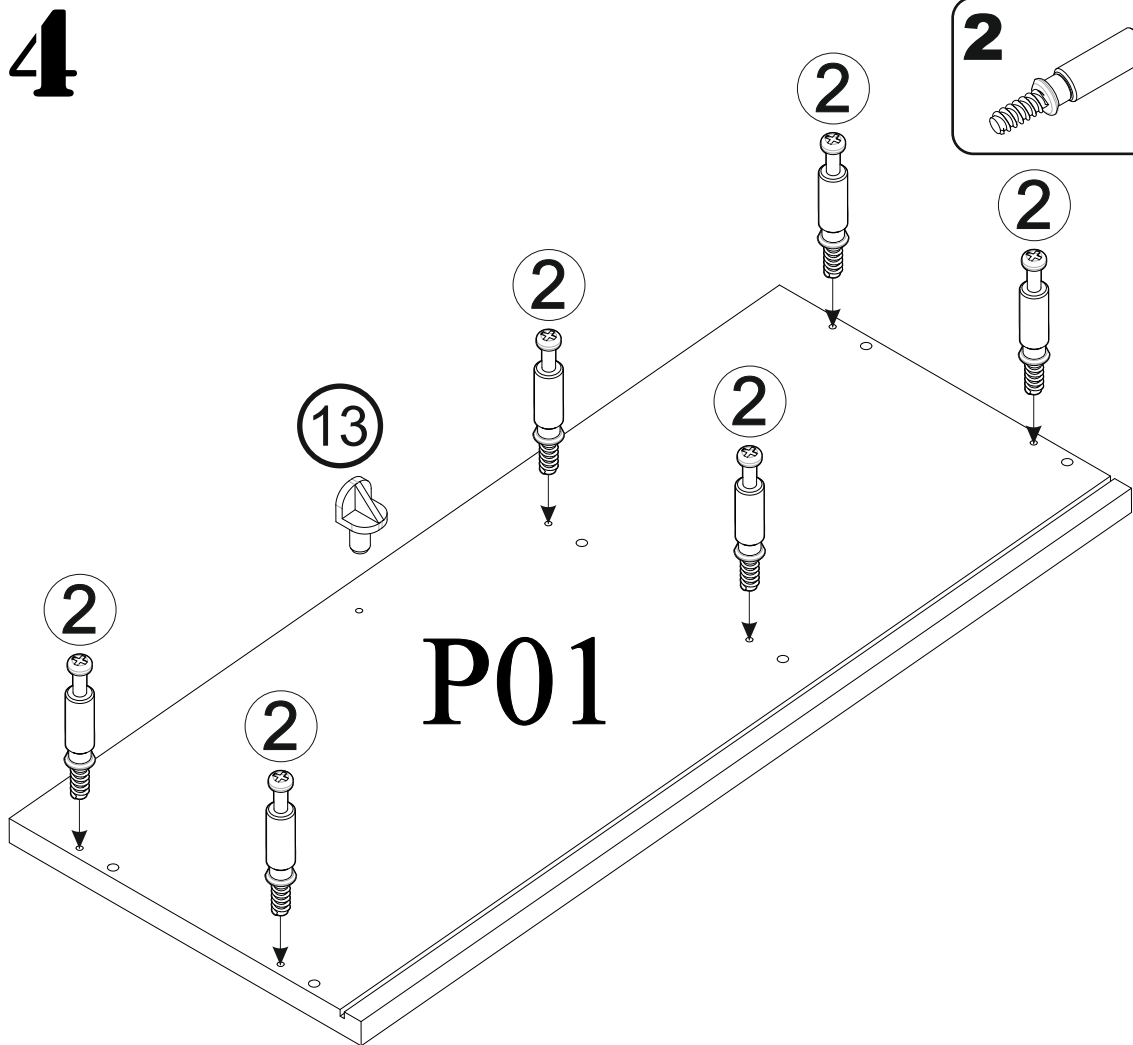

5

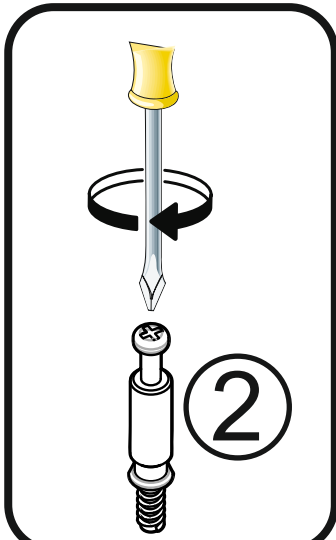
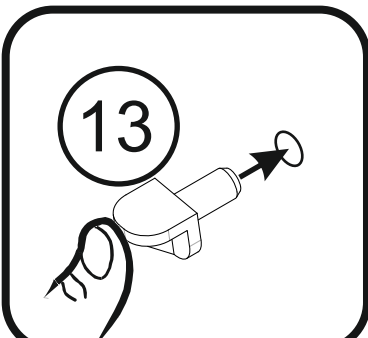
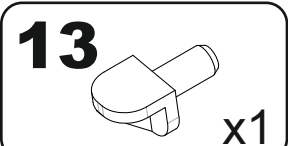
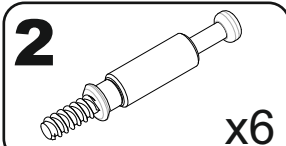
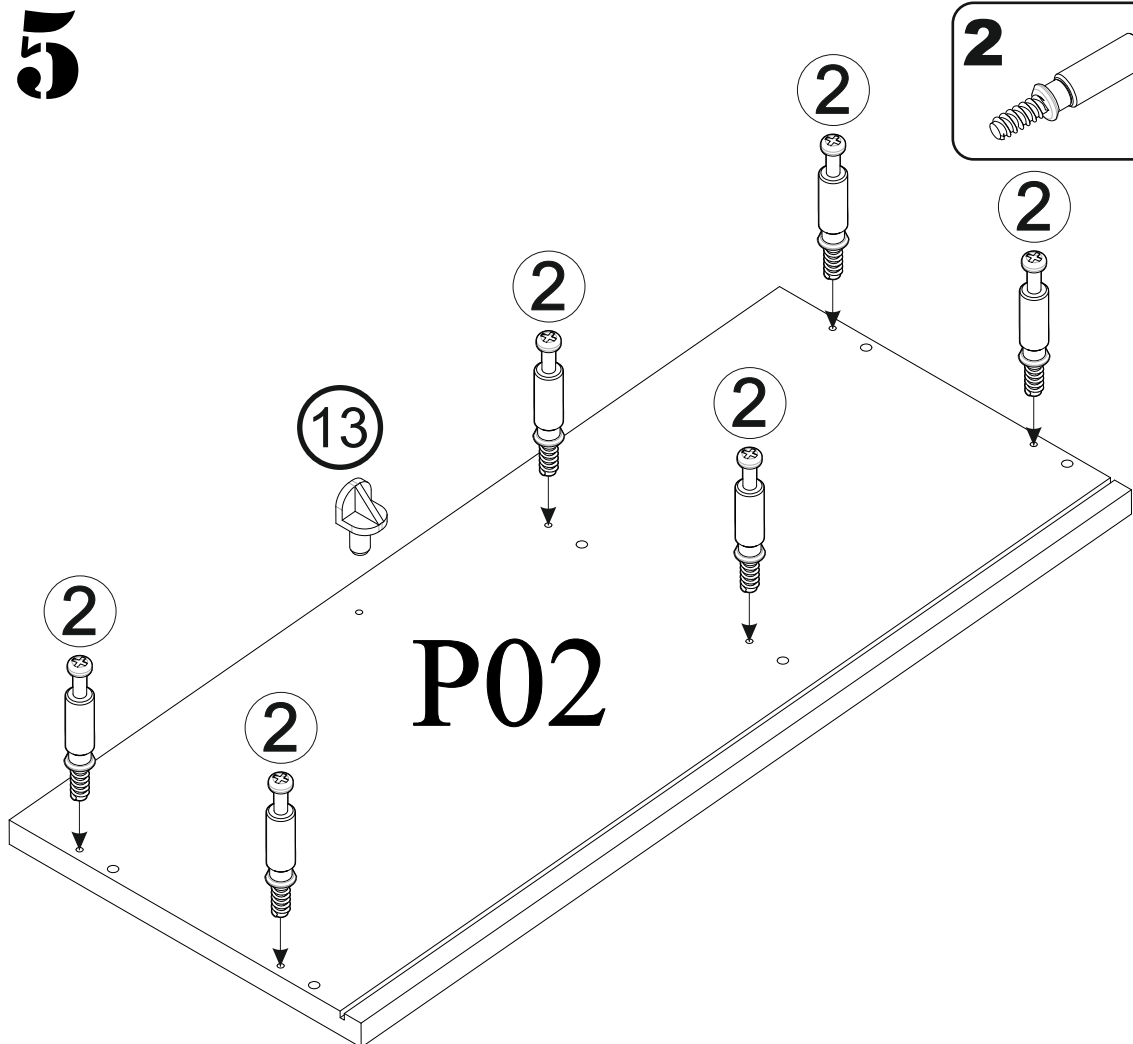

6

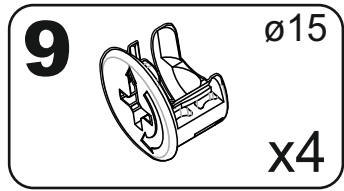

P21

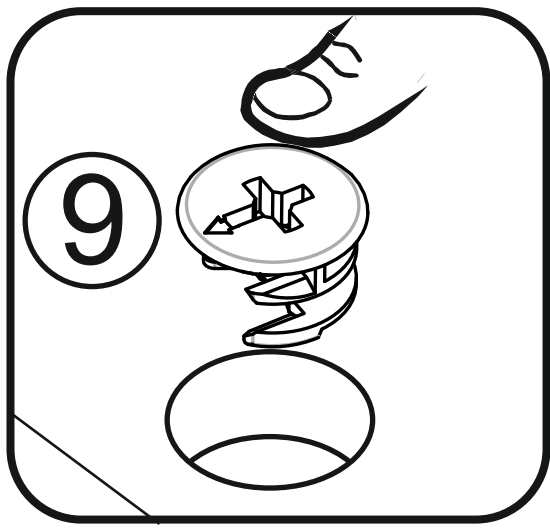
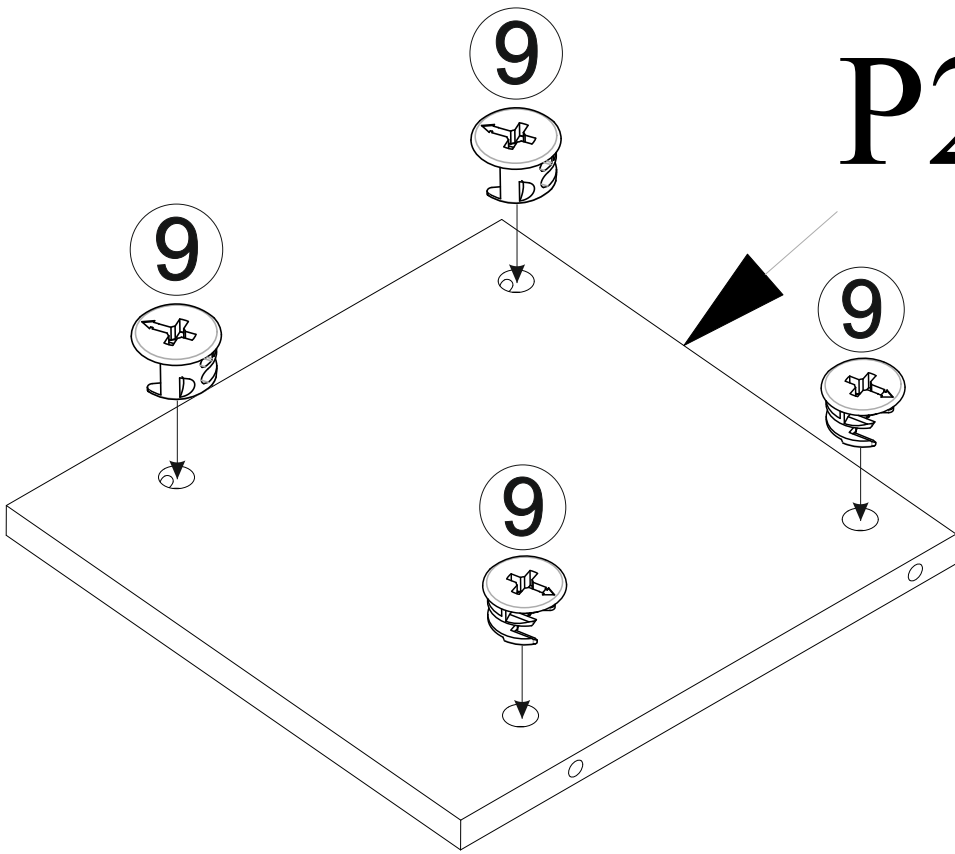

7

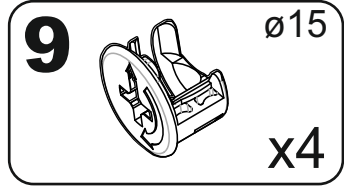

P20

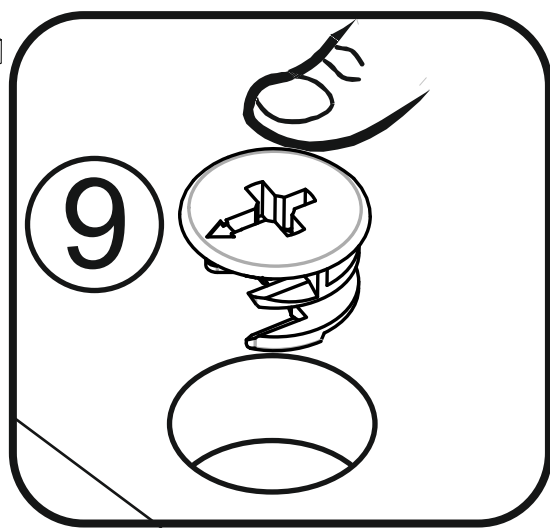
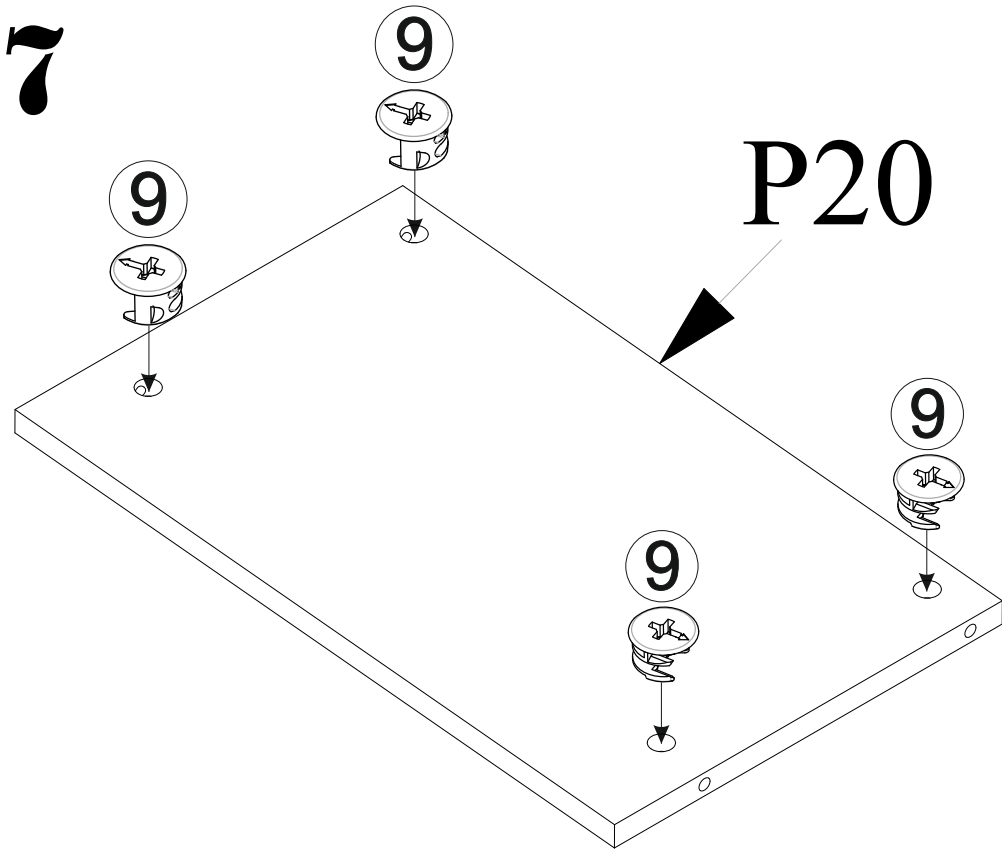

8

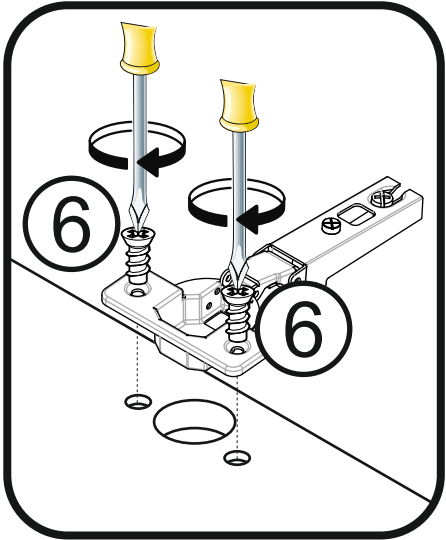
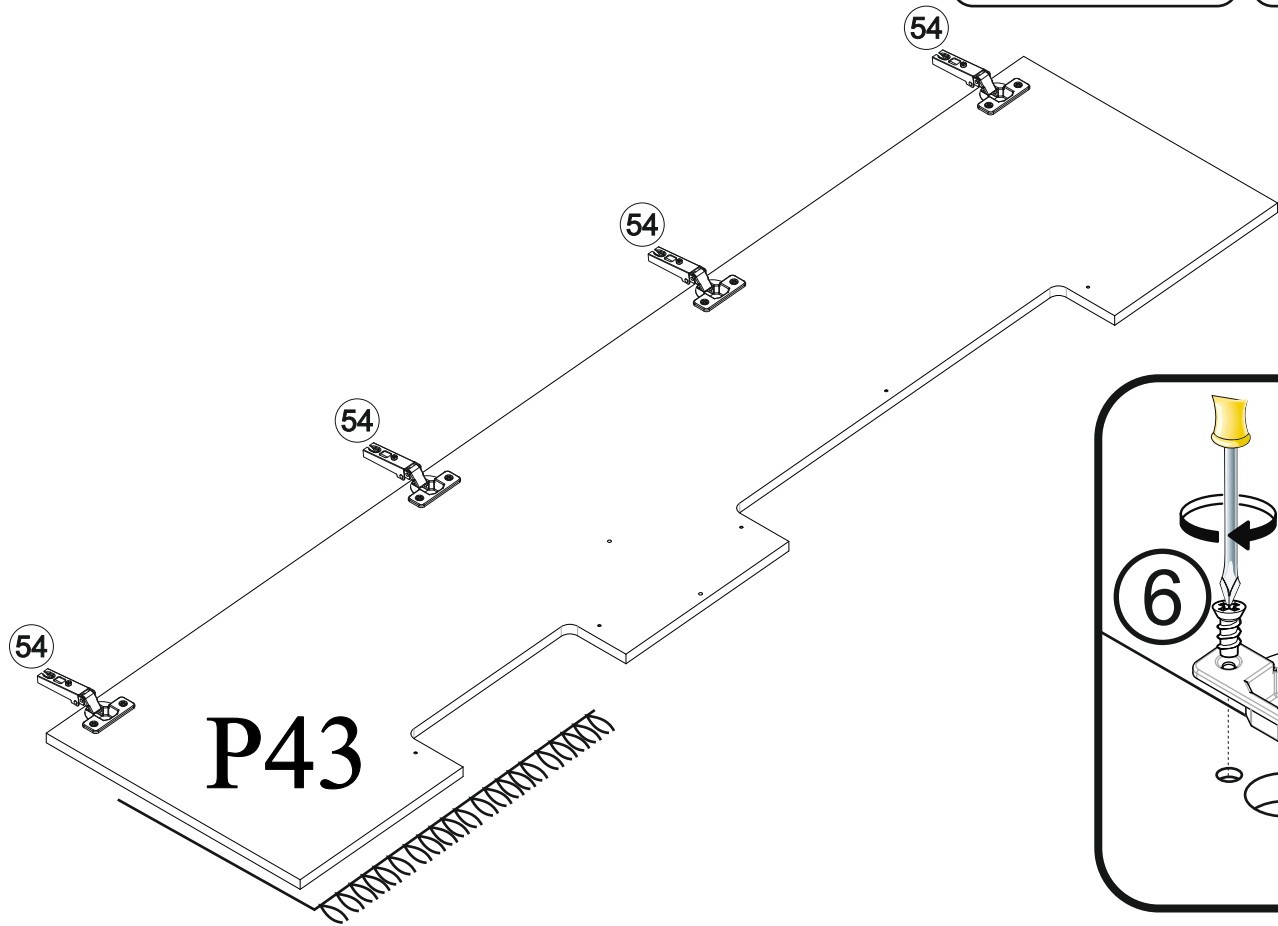
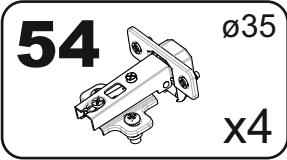
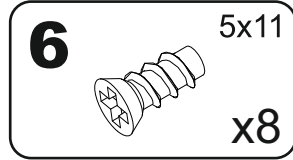

9

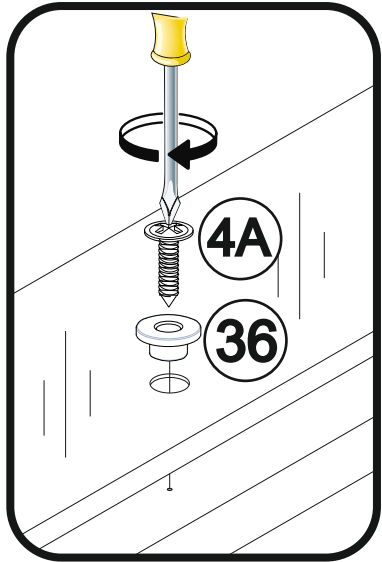
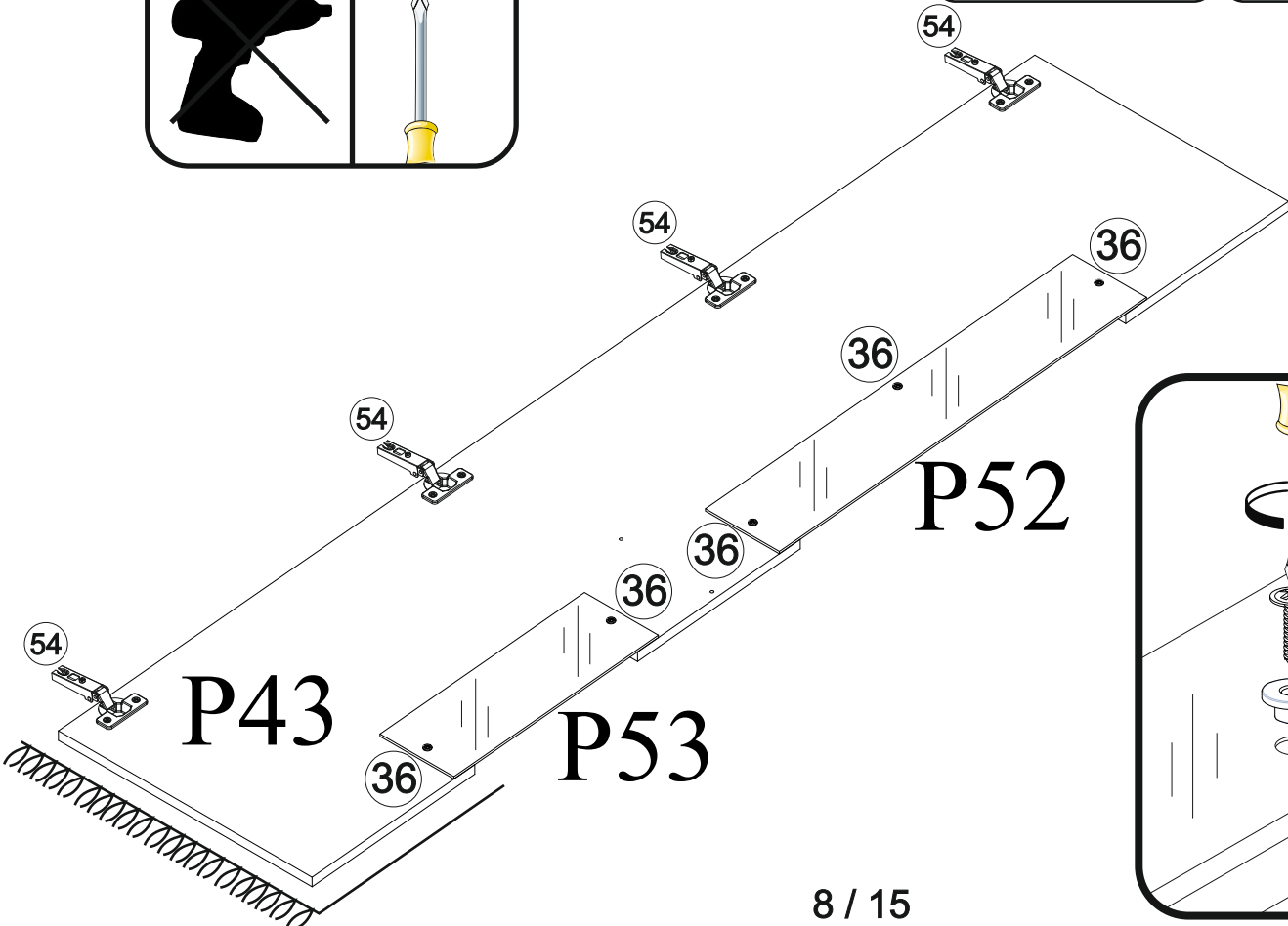
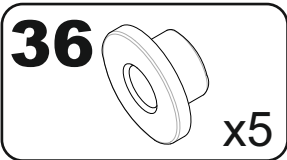
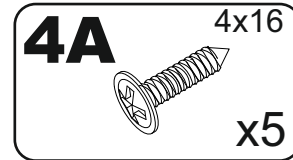
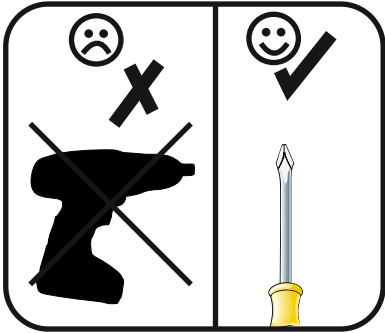

10

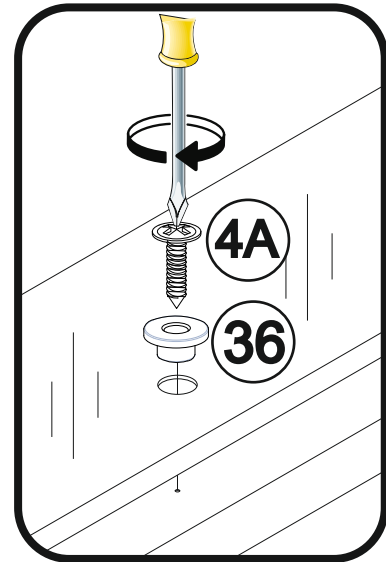
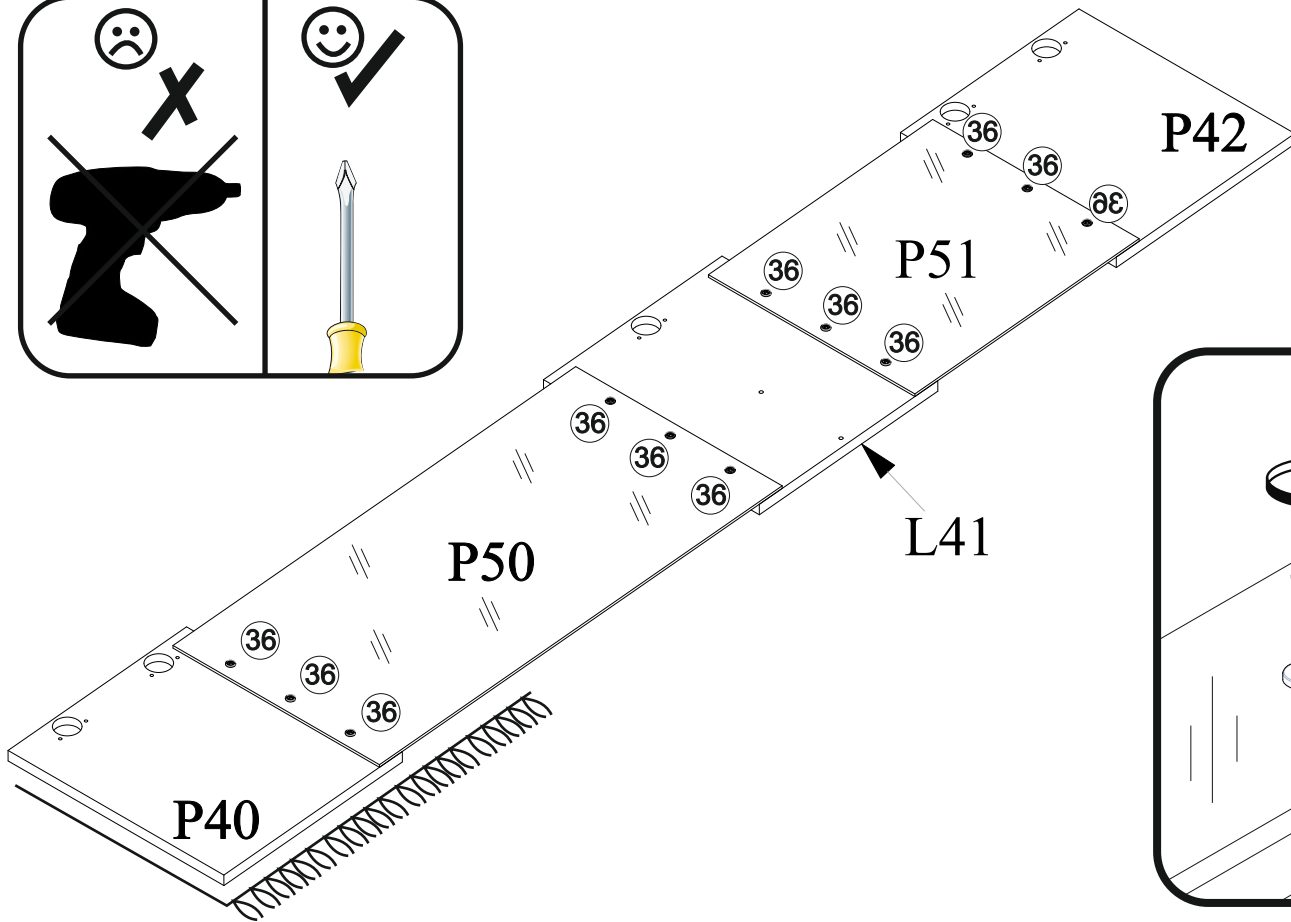
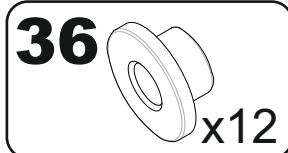
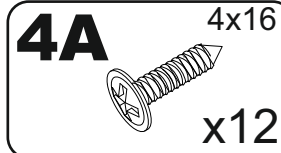
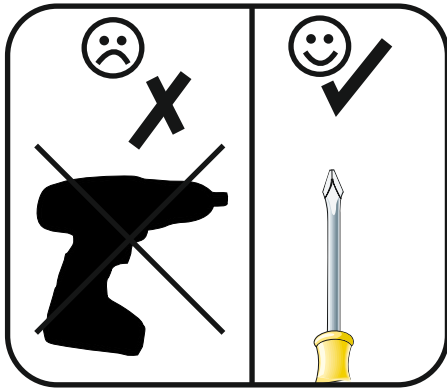

11

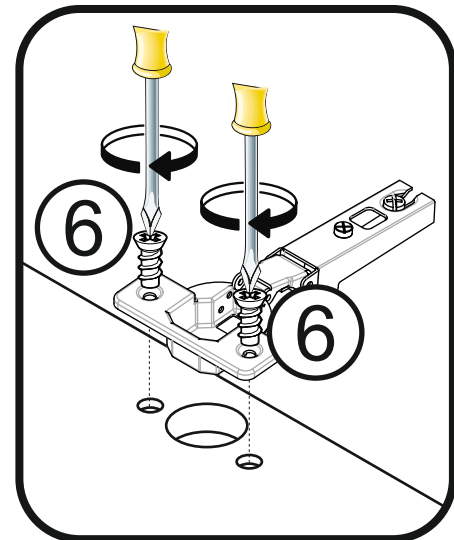
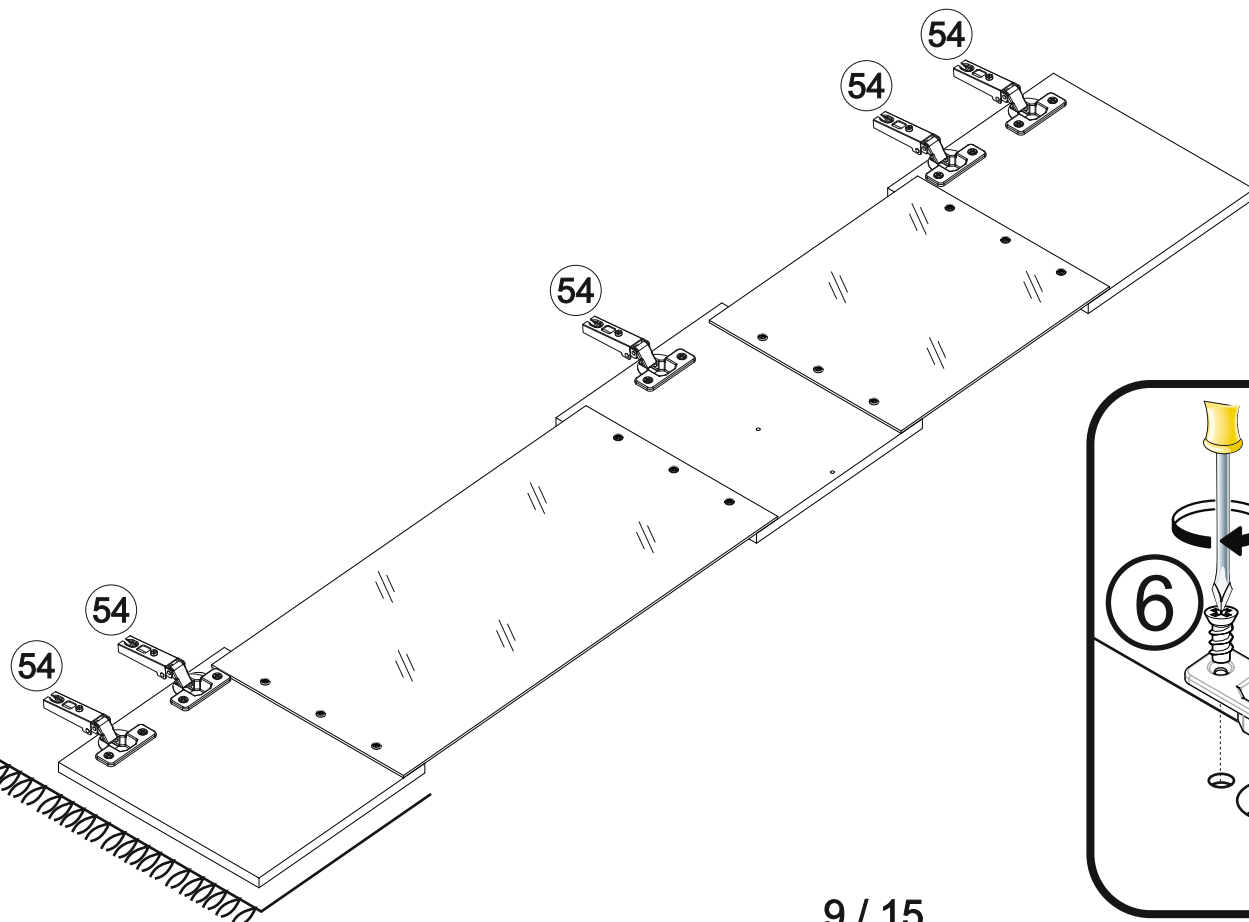
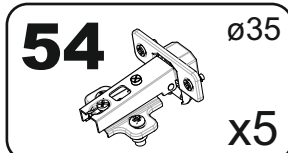
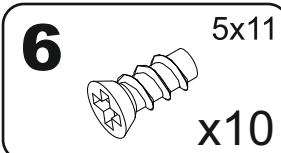

12

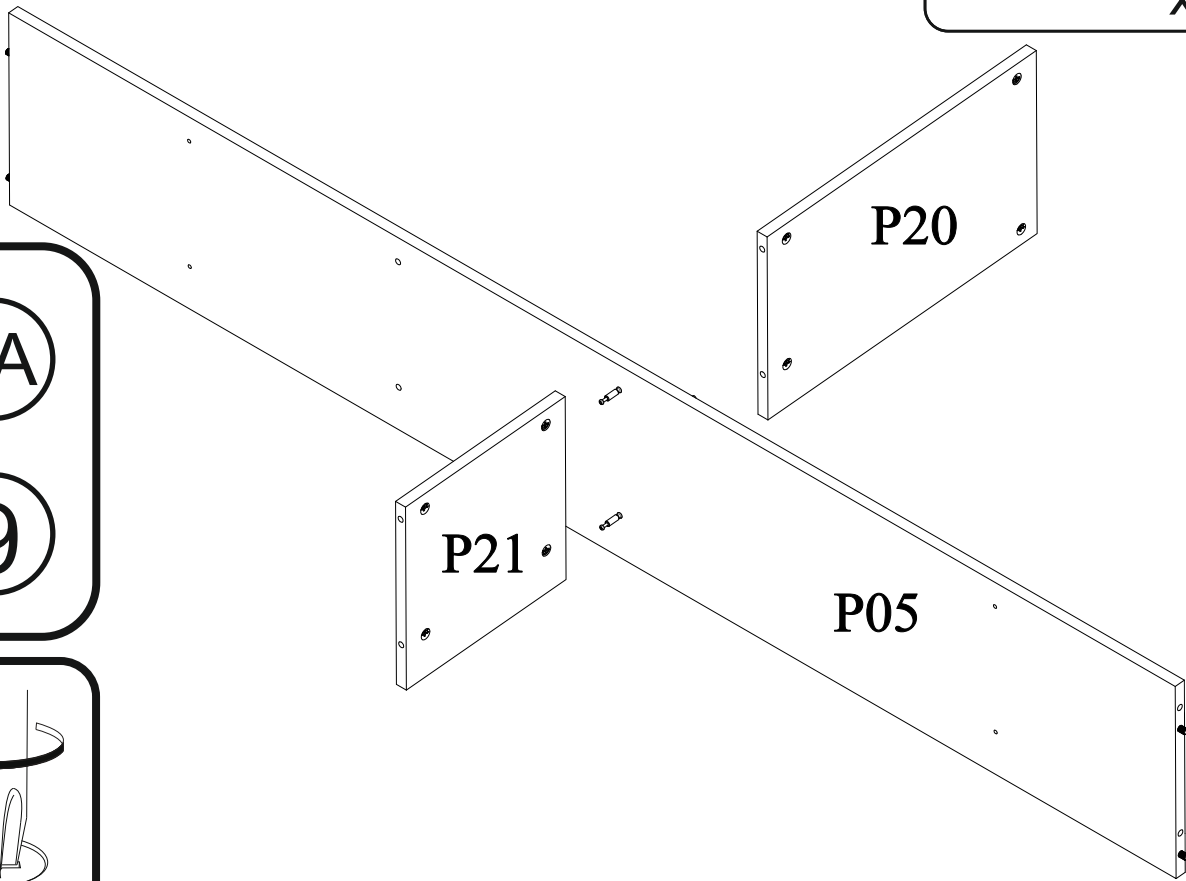
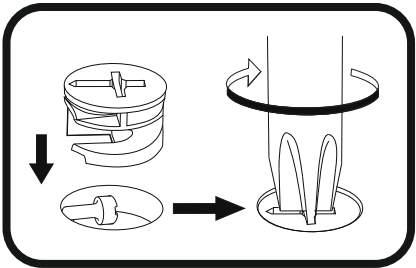
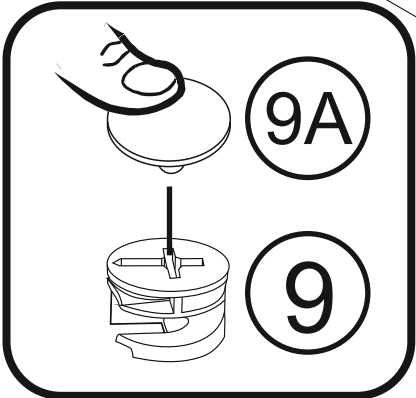
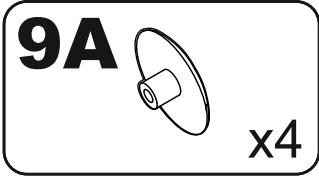

13

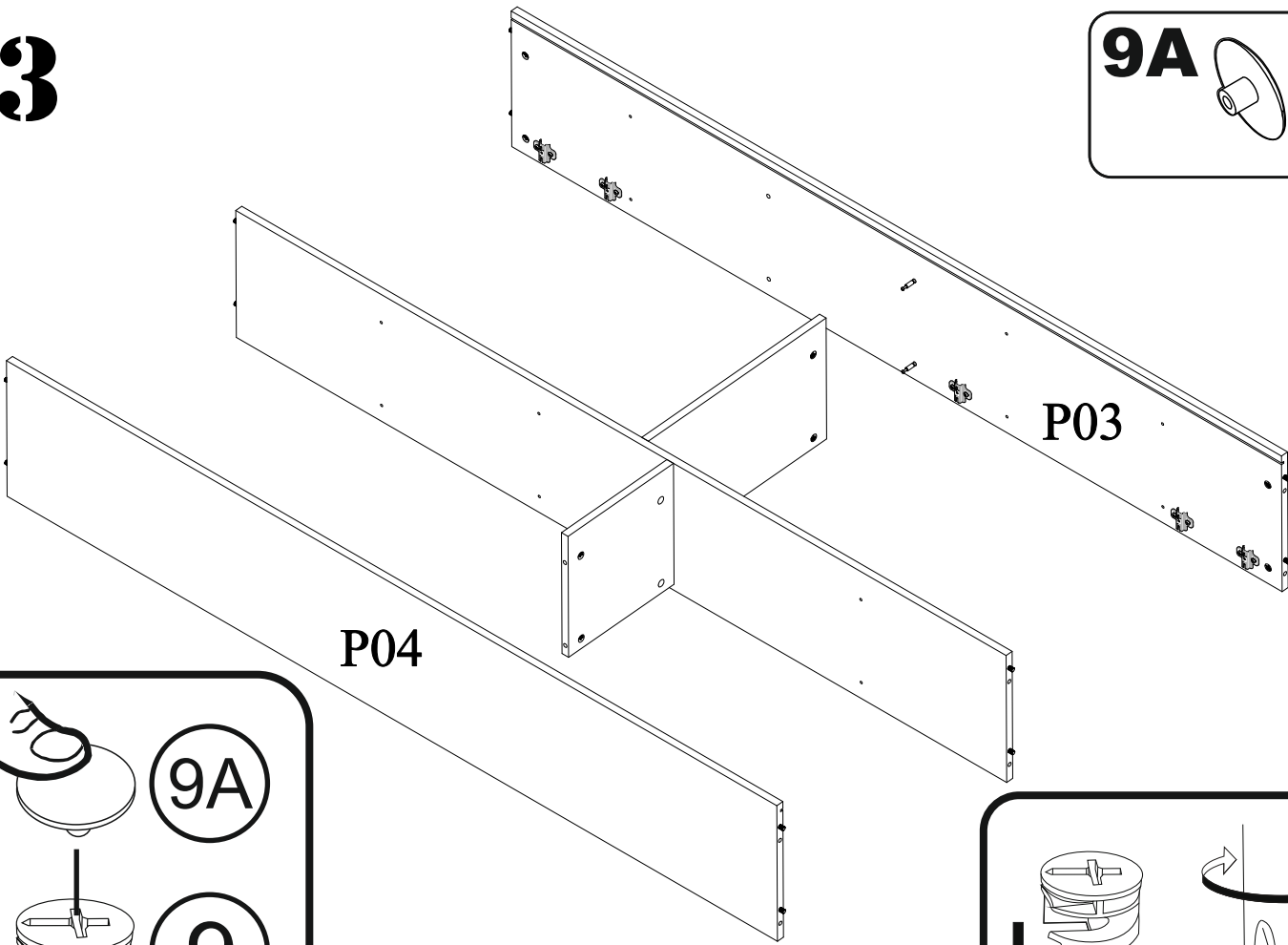
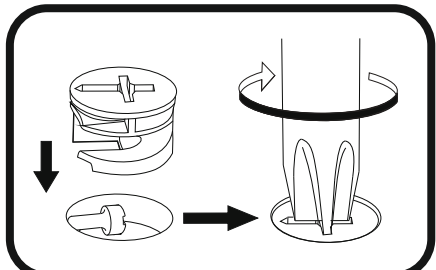
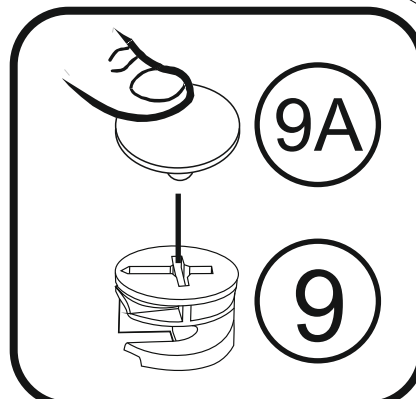
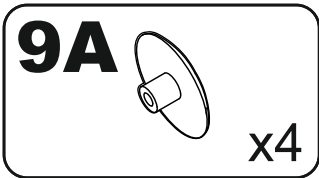

14

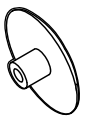
9A  x6

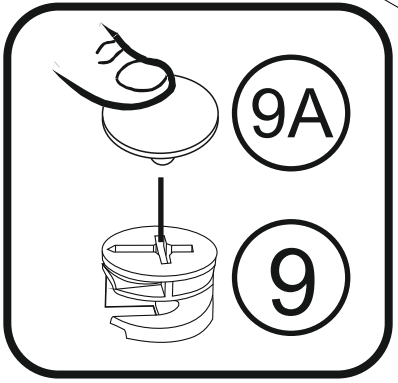
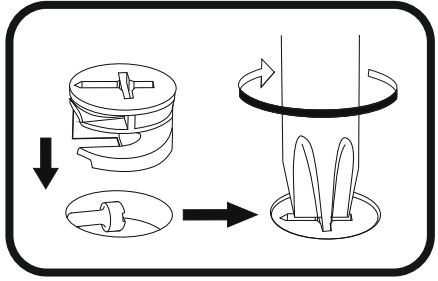
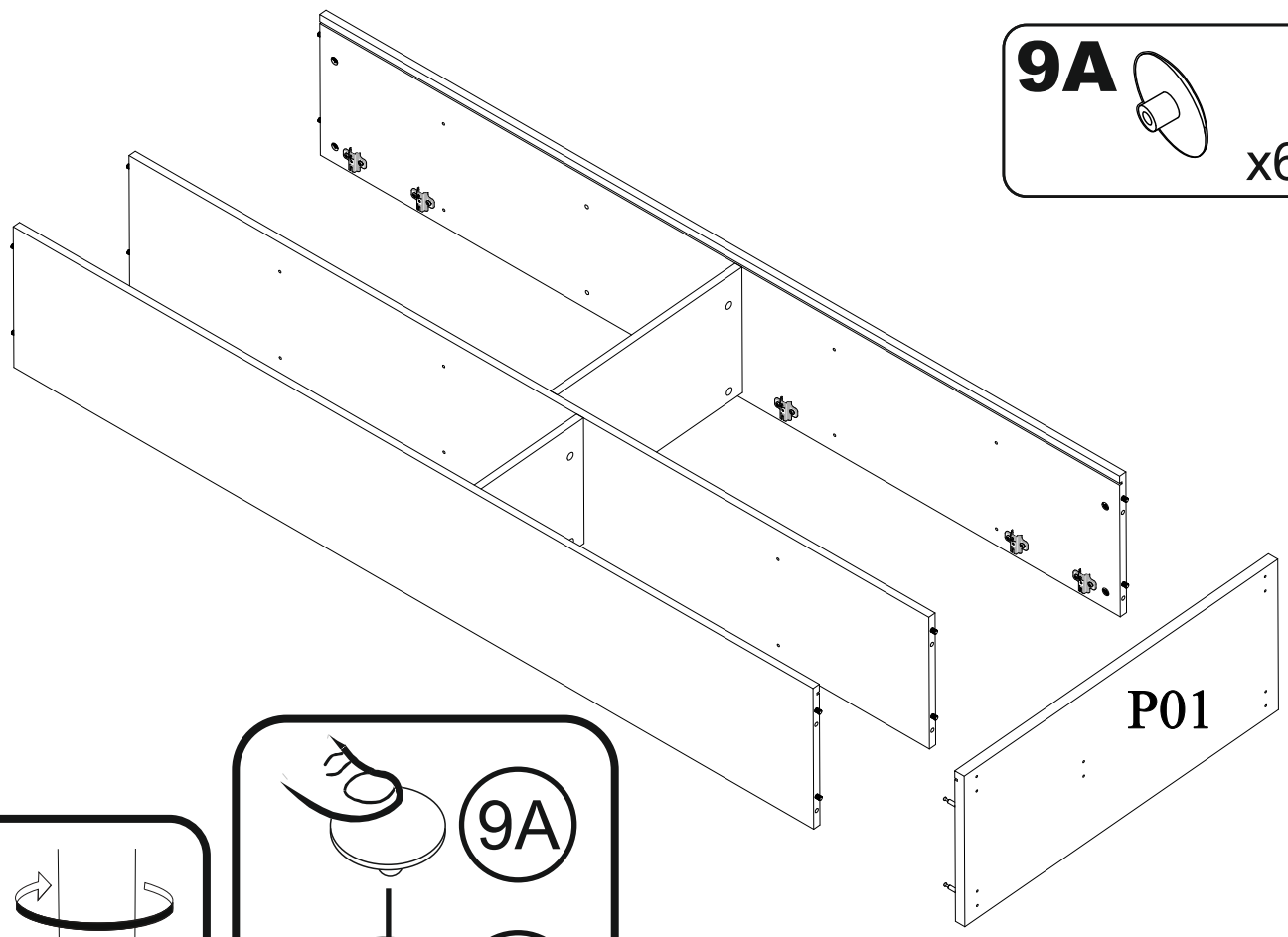

15

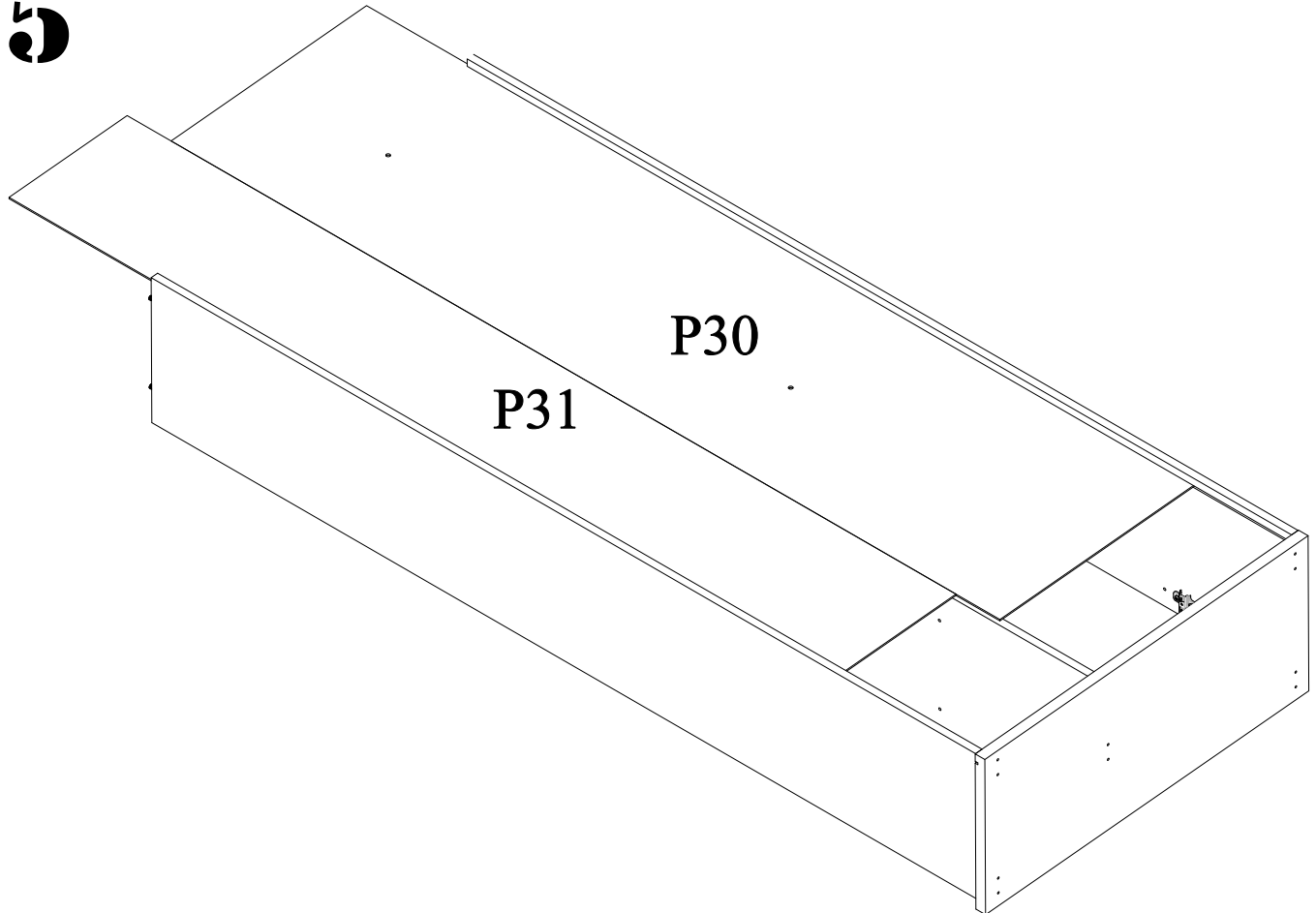

16

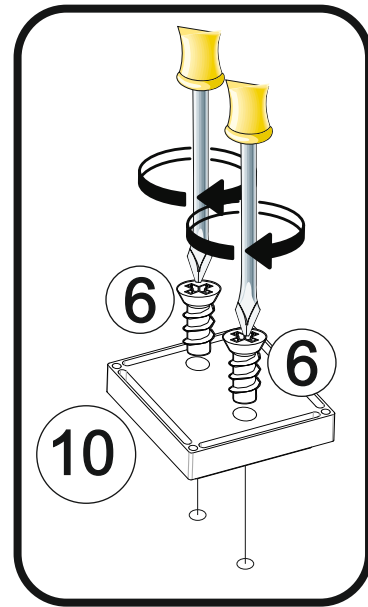
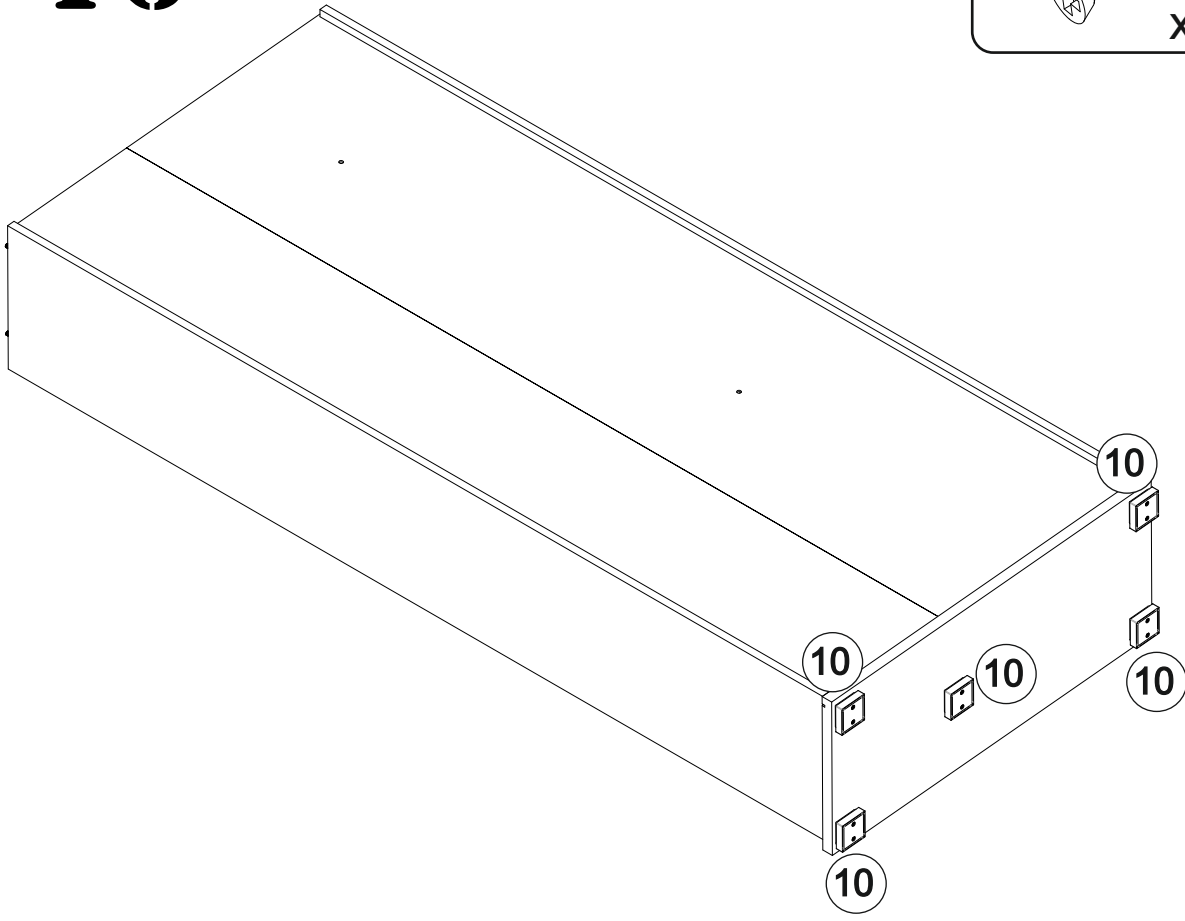
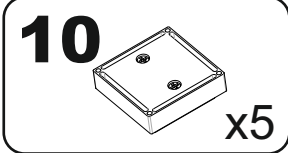
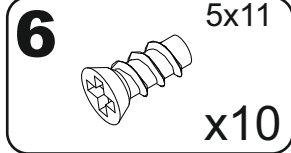

17

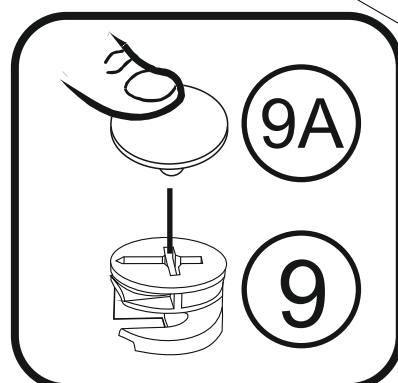
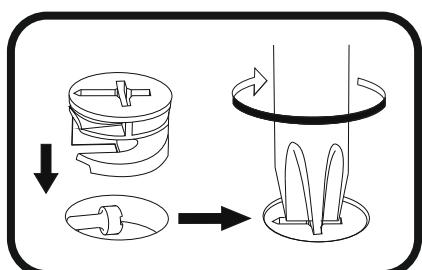
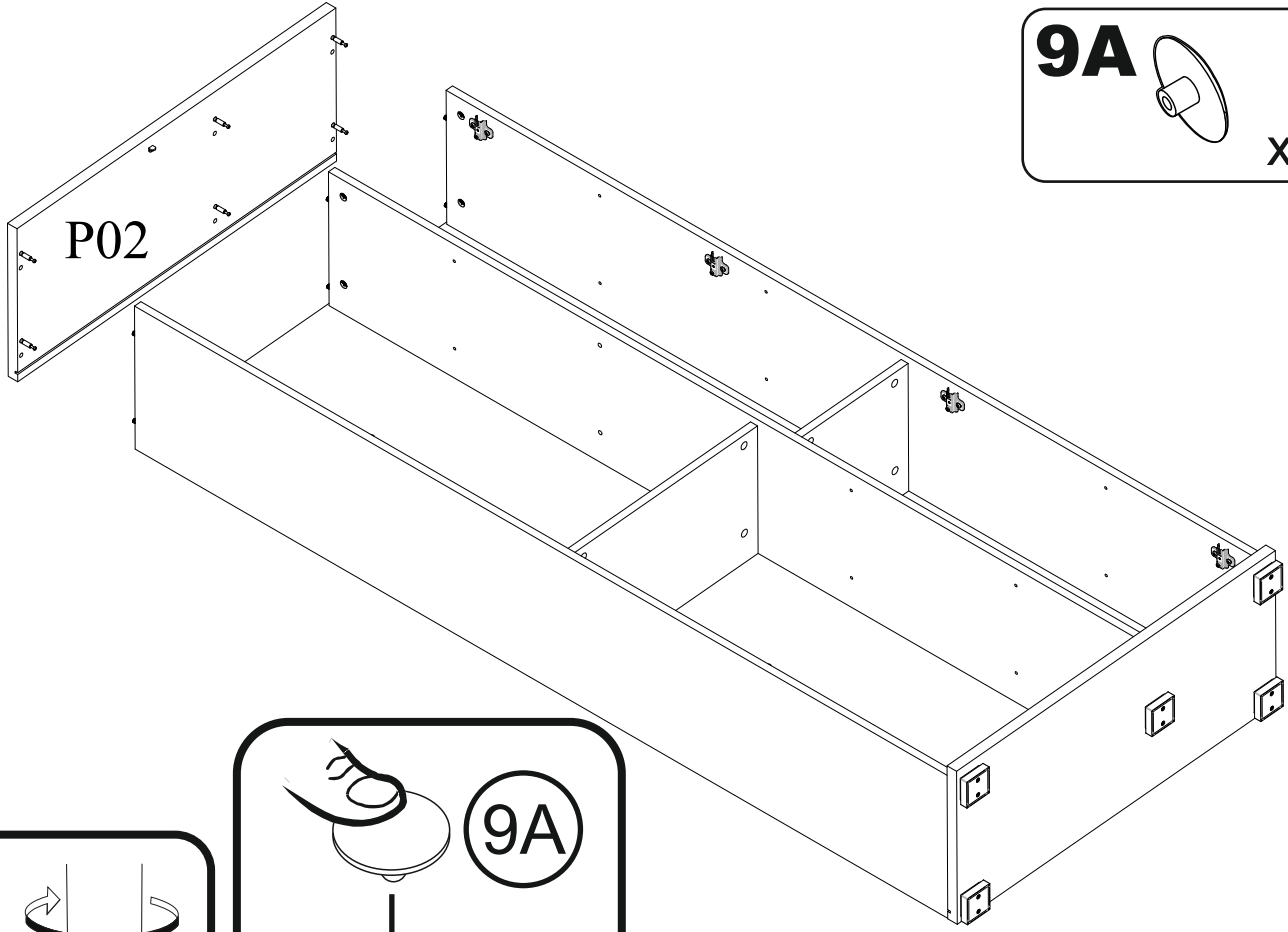
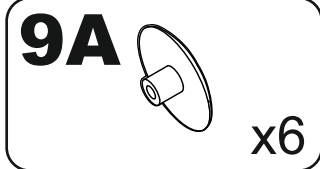

18

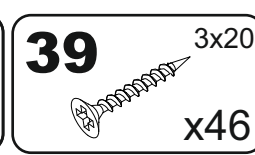
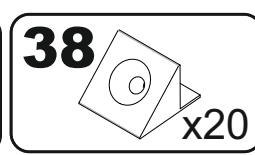
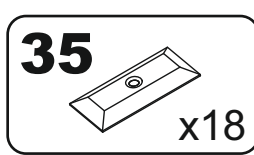
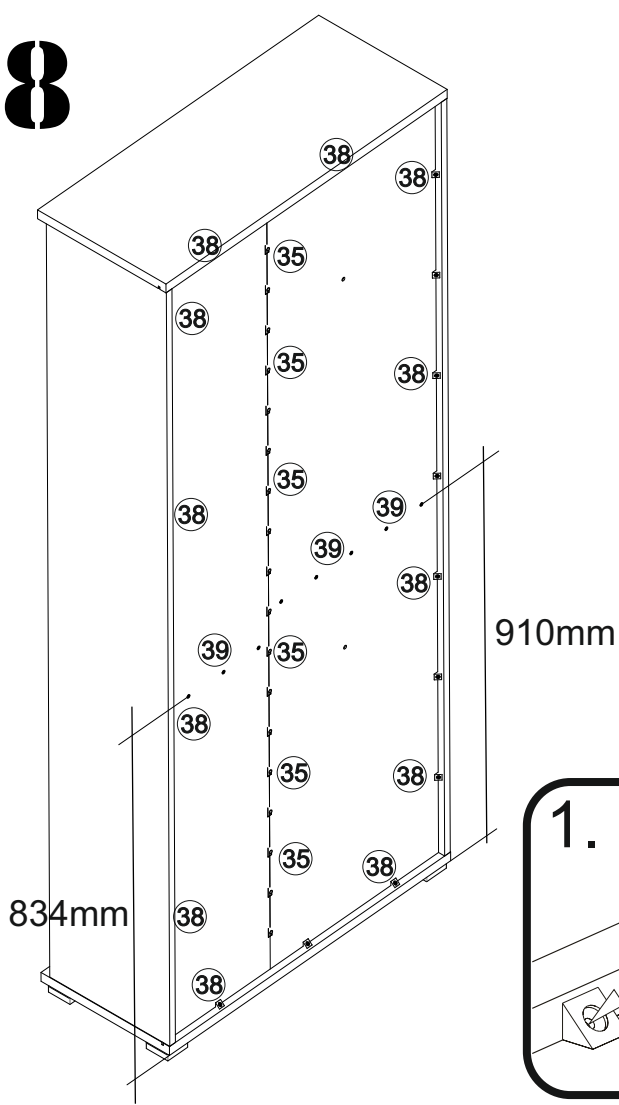

A=B

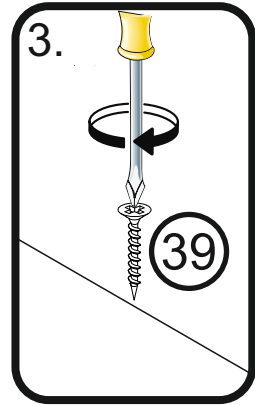
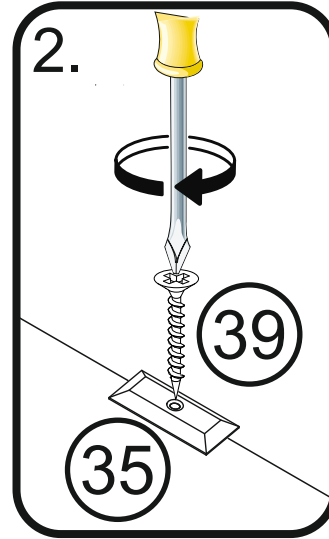
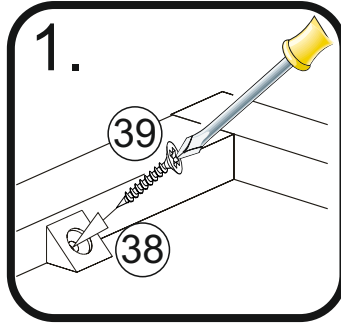
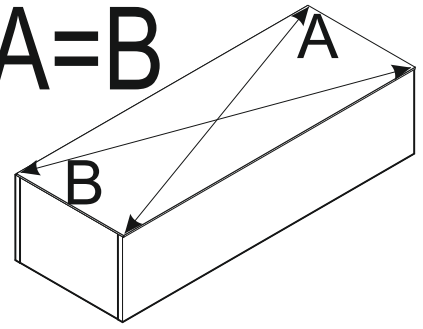

19

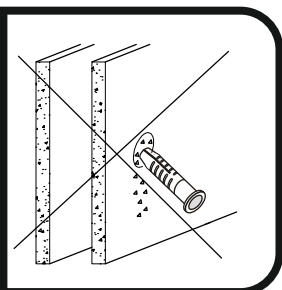
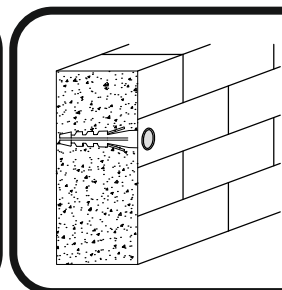
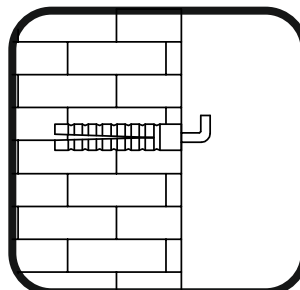
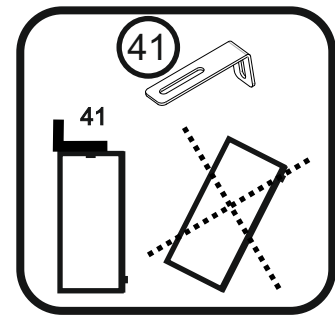
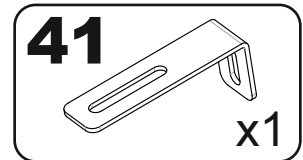
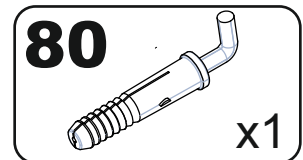
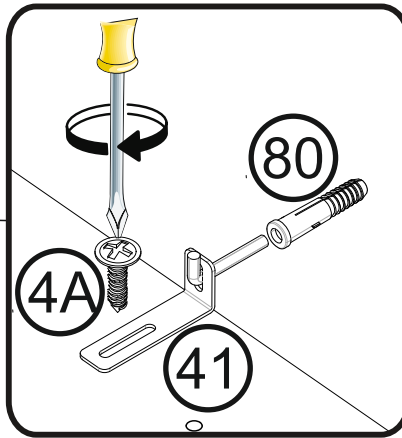
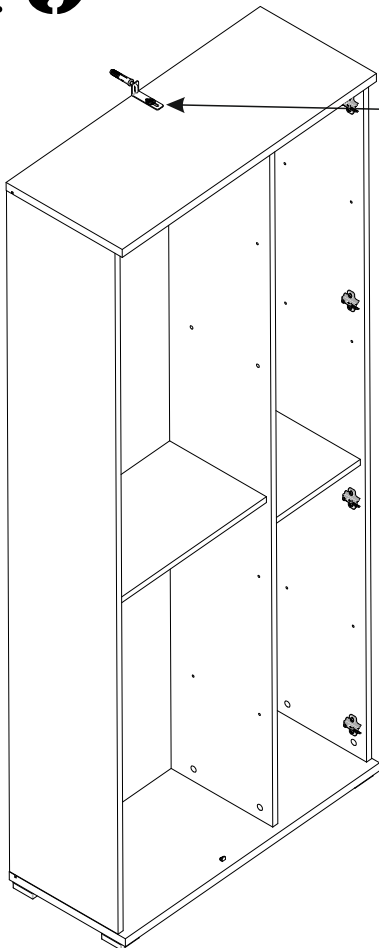

20

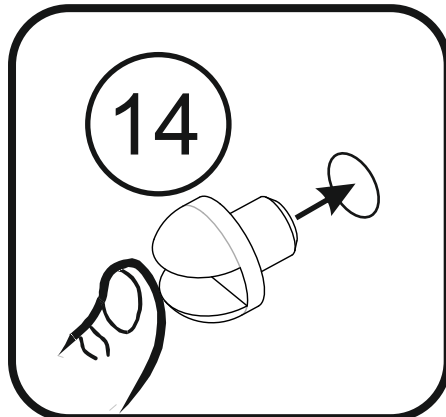
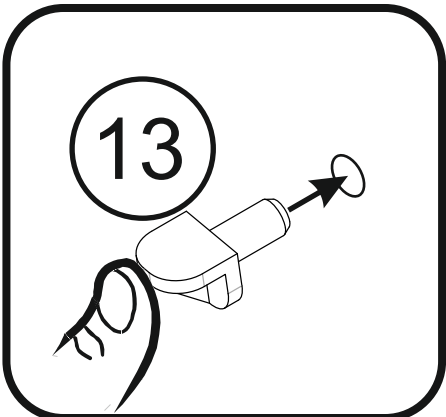
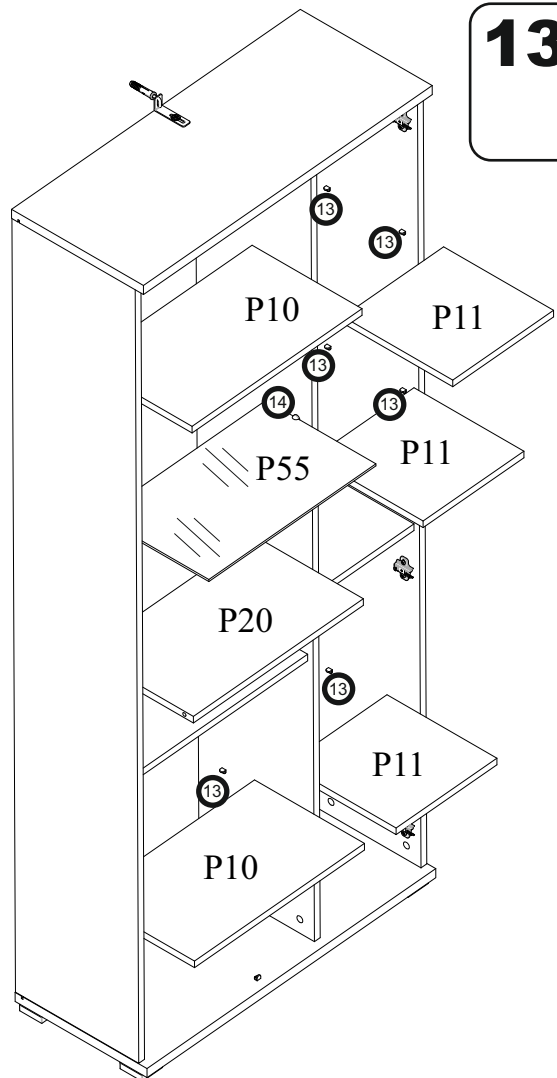
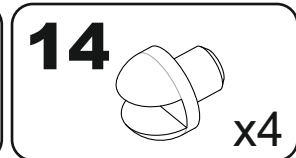
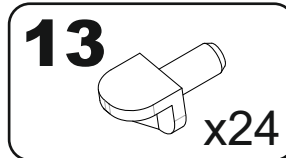

21

