

# THIN 27\_THWSN

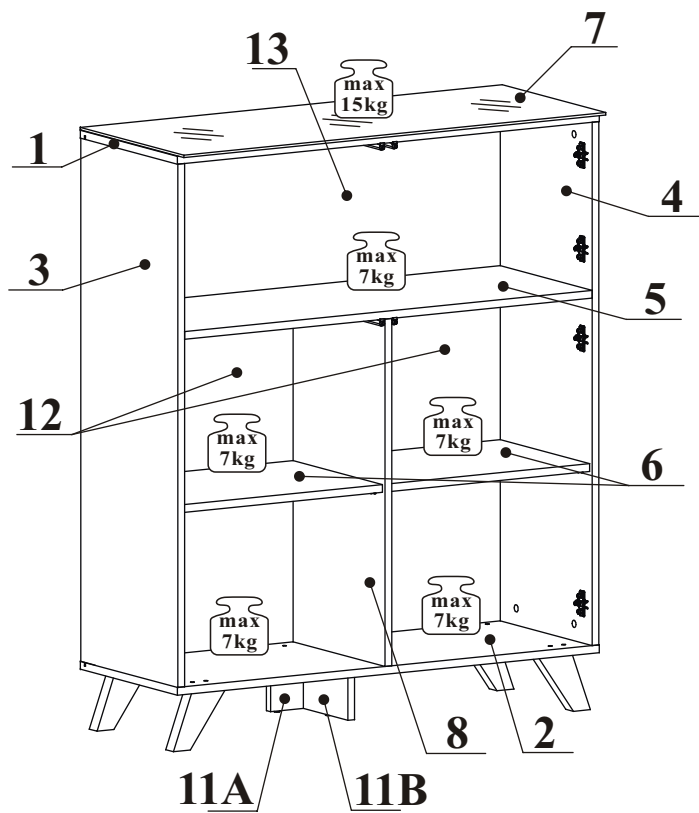

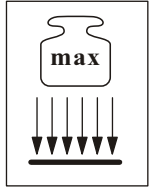

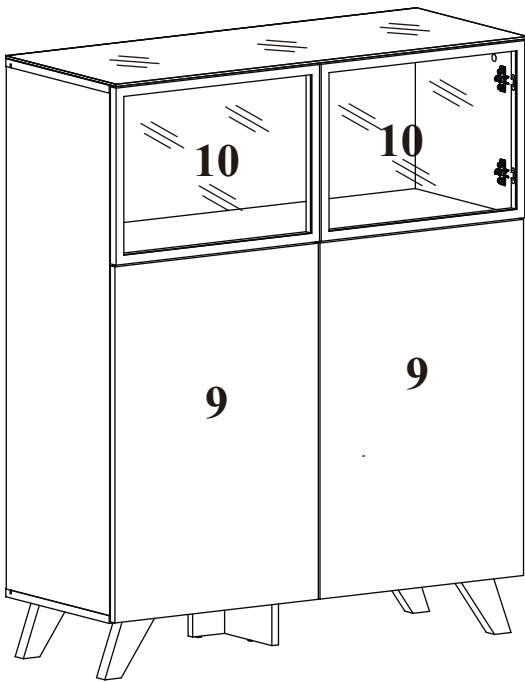

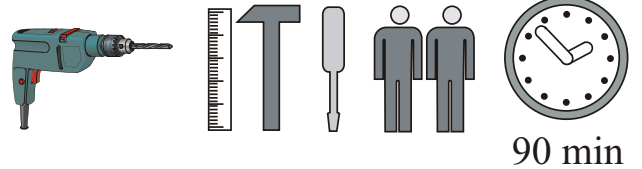



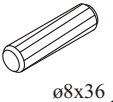
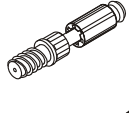

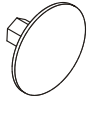
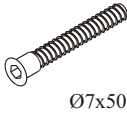

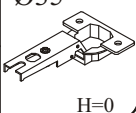
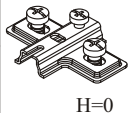
NO	Dim.		Col.-No	Qty
1	1002	376	1	1
2	1002	376	1	1
3	1074	376	1	1
4	1074	376	1	1
5	968	356	1	1
6	476	346	1	2
7	1002	401	1	1
8	713	356	1	1
9	496	732	2	2
10	496	364	2	2
11A	115	172	1	1
11B	115	172	1	1
12	490	727	2	2
13	980	359	1	1

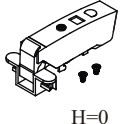
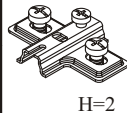
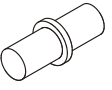
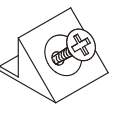
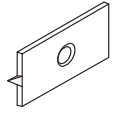

90 min

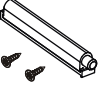
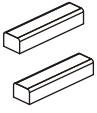
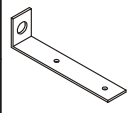
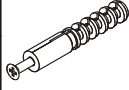
# THIN 27\_THWSN

A1 x16  ø8x36	B4 x16 	B5 x16  Ø15x12	G5 x16 	B11 x14  Ø7x50	G4 x14 
E21 x4 Ø35  H=0	E2 x4  H=0	D10 x18  USØ3,5x13	E30 x4  H=0	E4 x4  H=2	G7 x8 
S1 x16 	G16 x10 	UP13 x10  UPØ3x16	SK x4  H=120	I2 x3 	OD1 x4 
LED X2 	L1 x1 	KR1 x1 	G2 x1 		

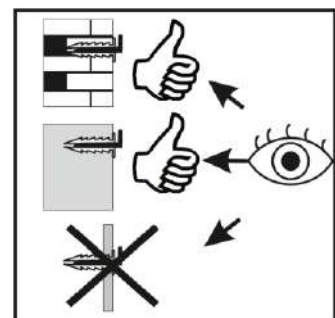
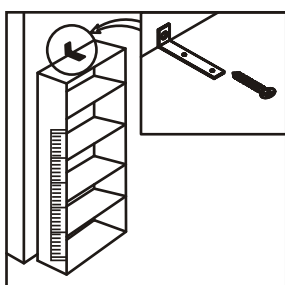
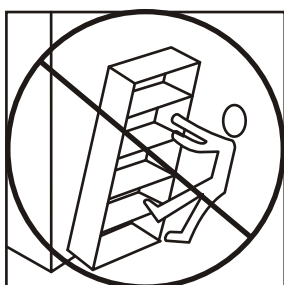
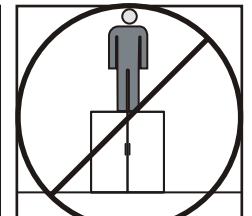
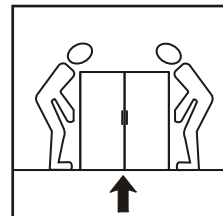
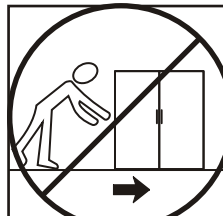
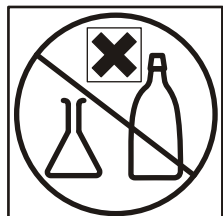
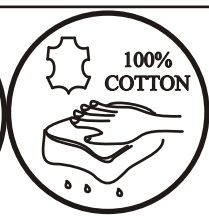
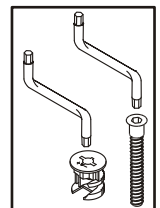
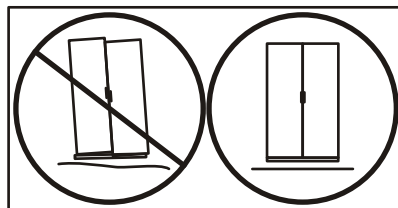
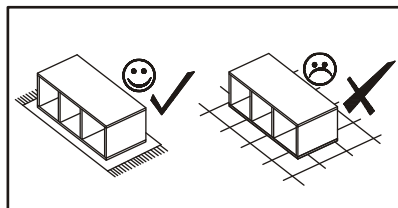
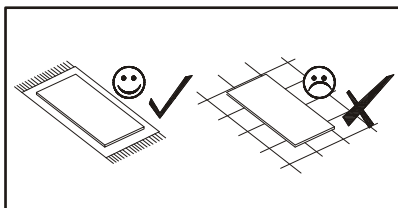
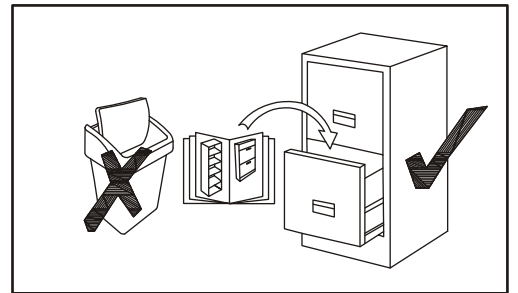
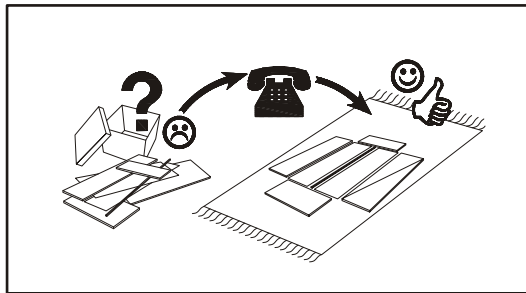
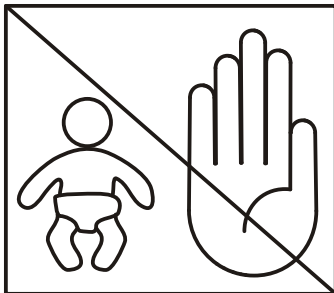
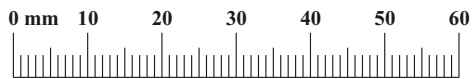

1

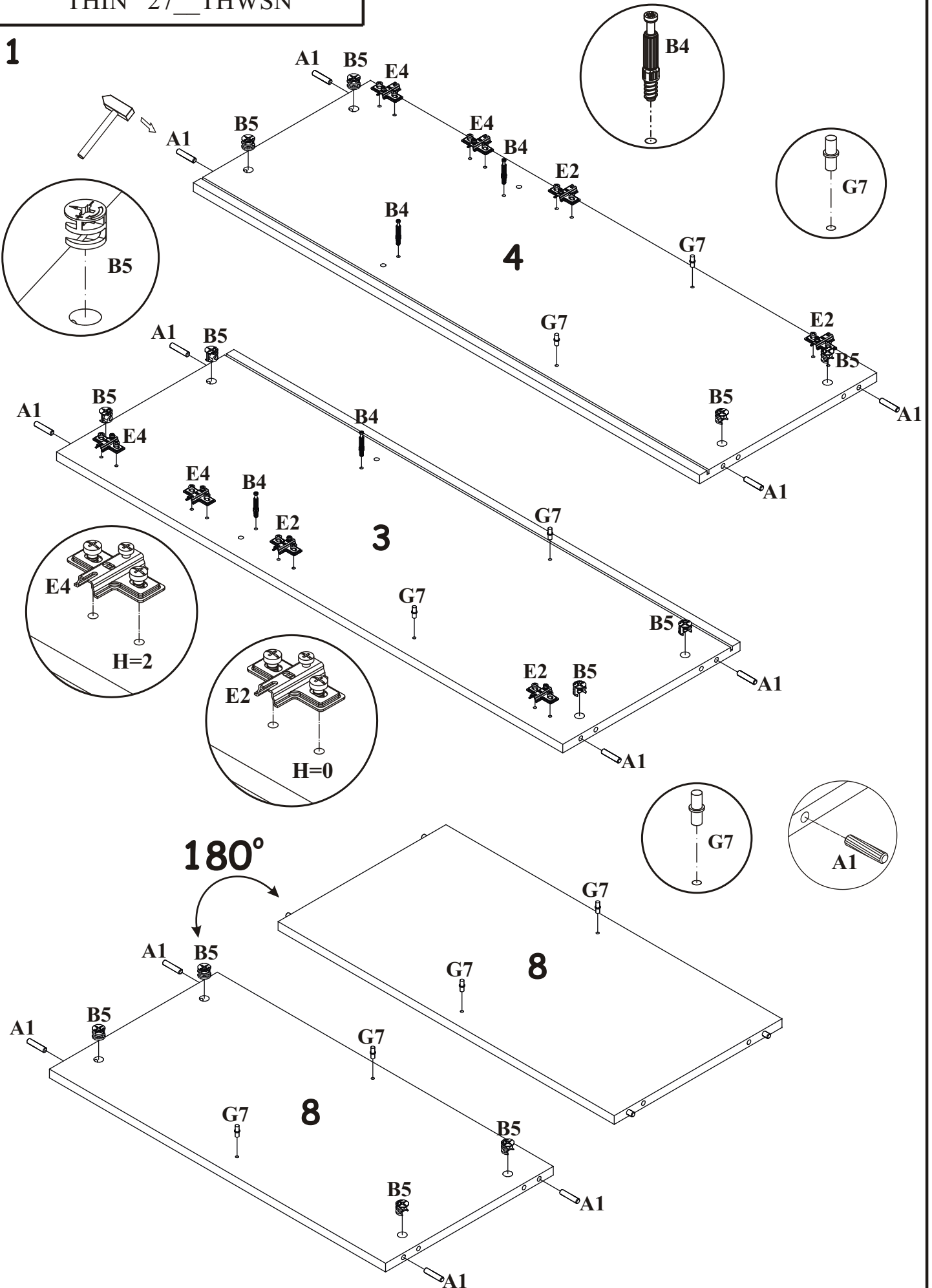

2

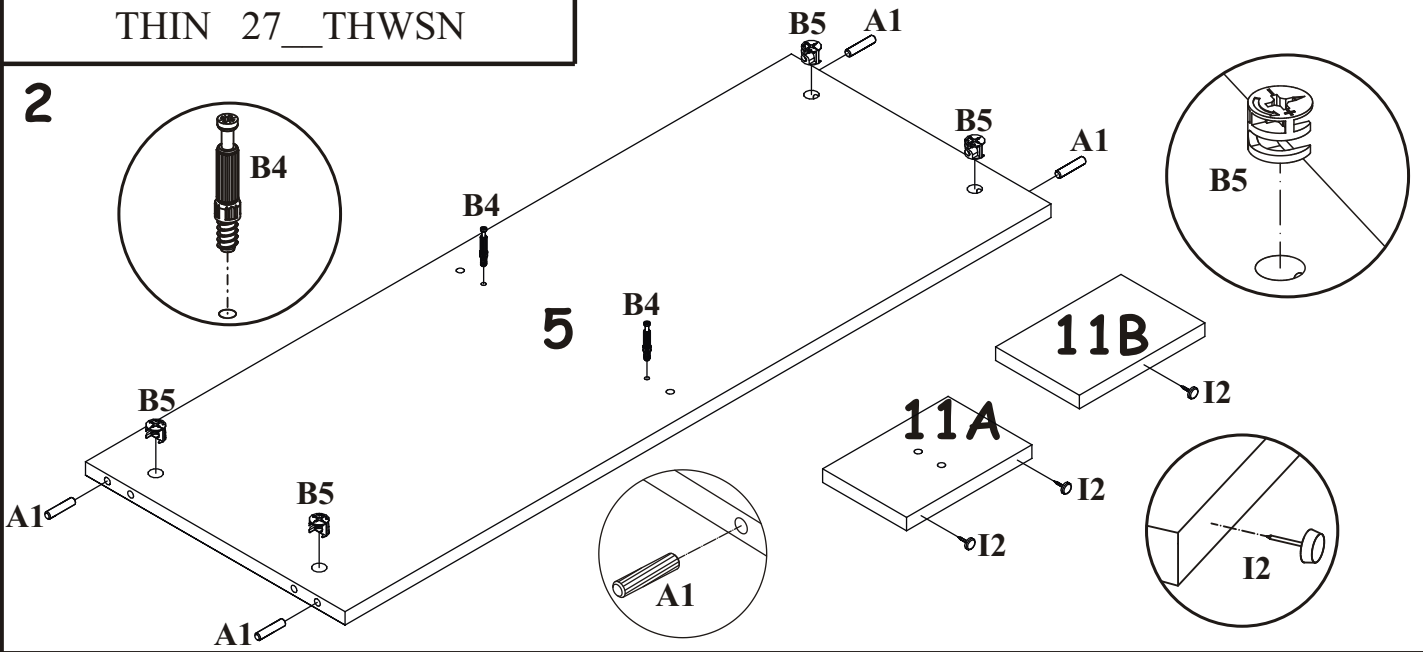

3

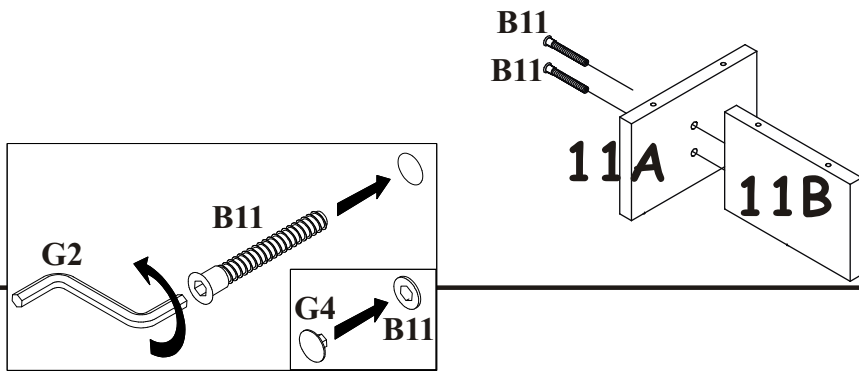

4

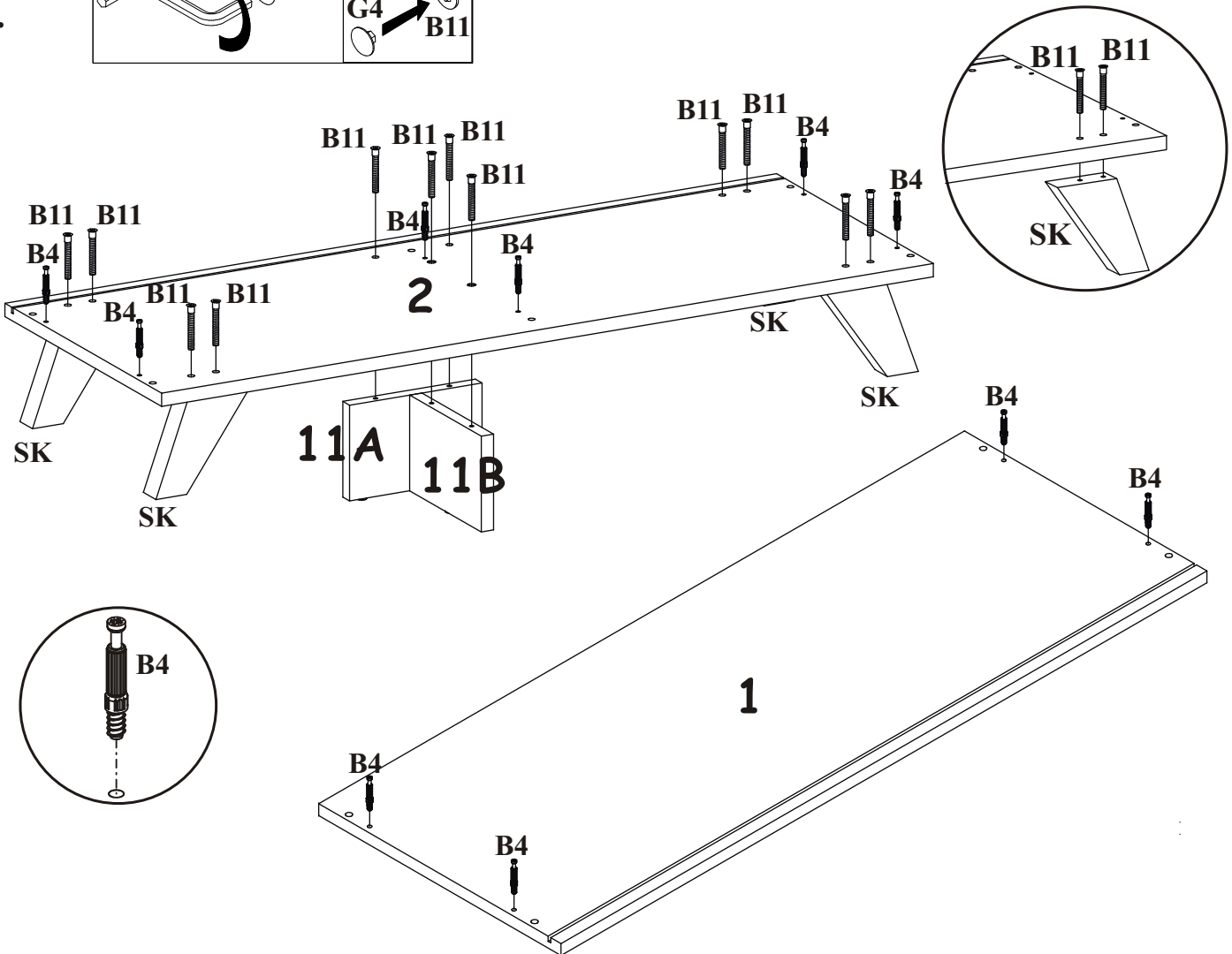

5

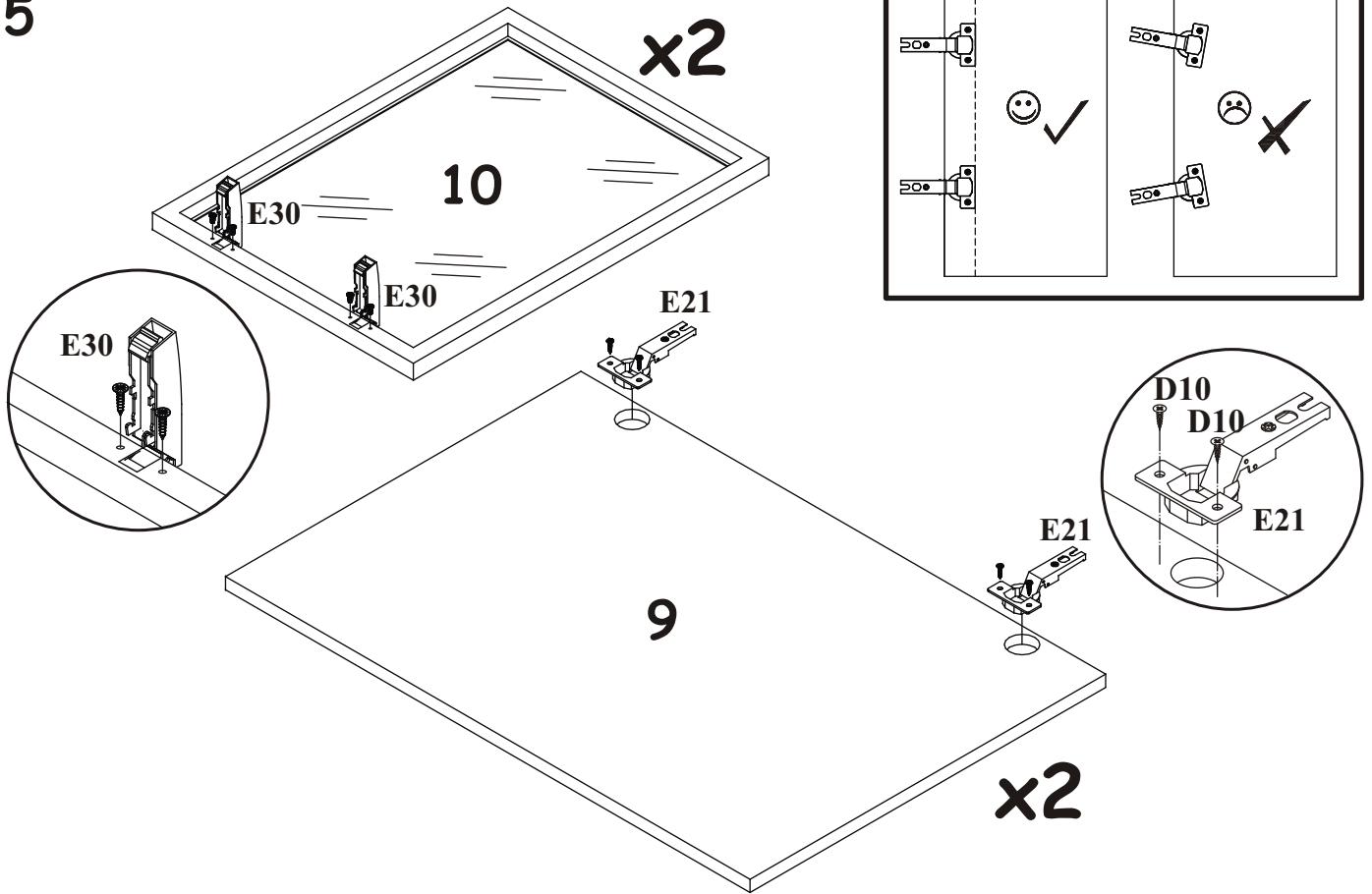

6

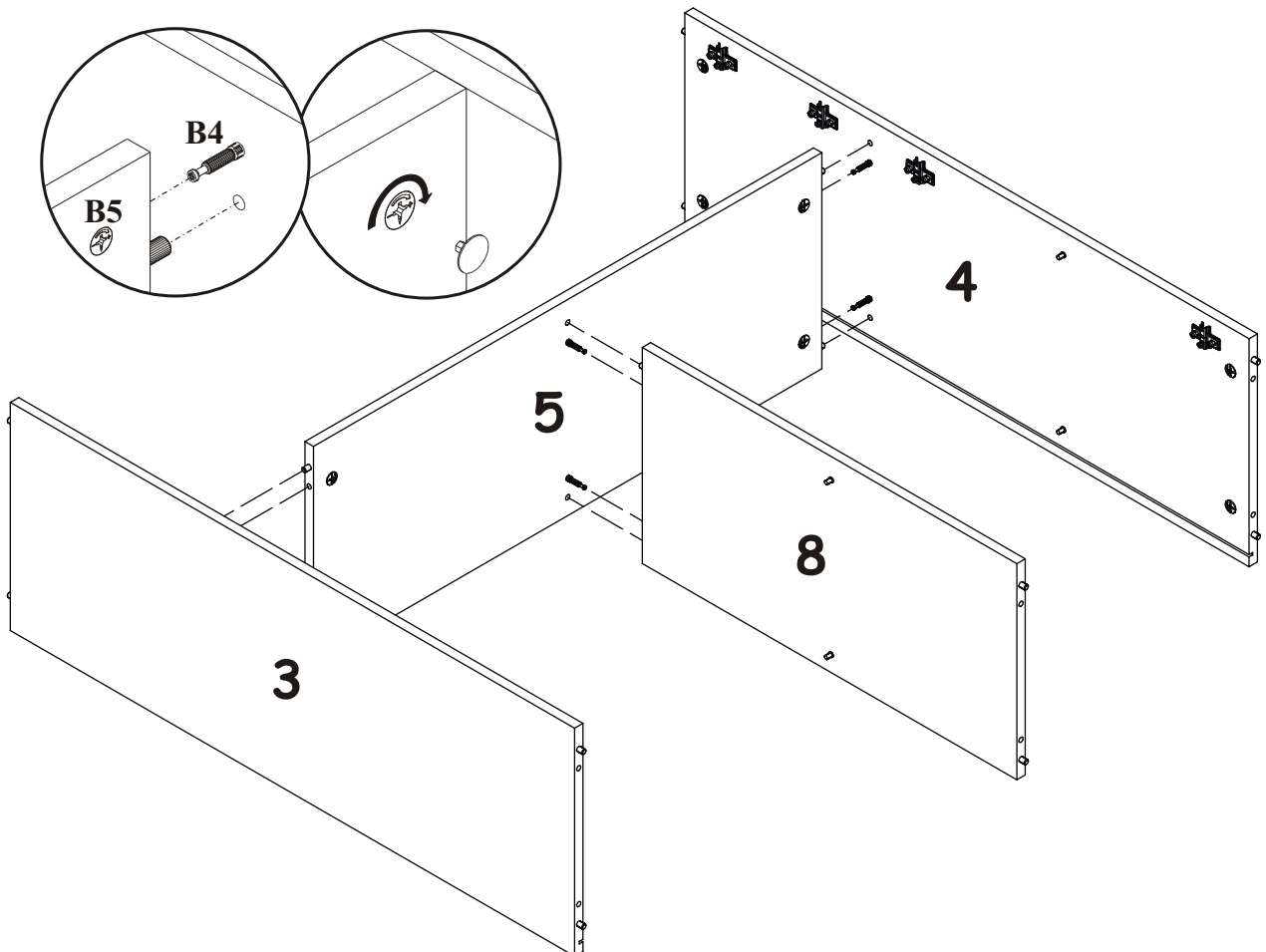

7

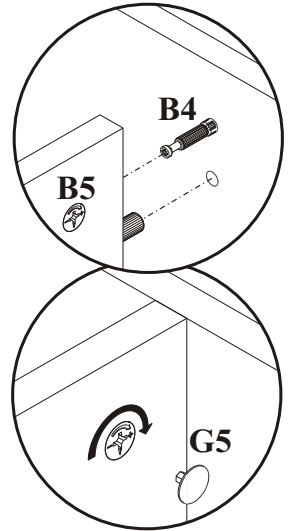
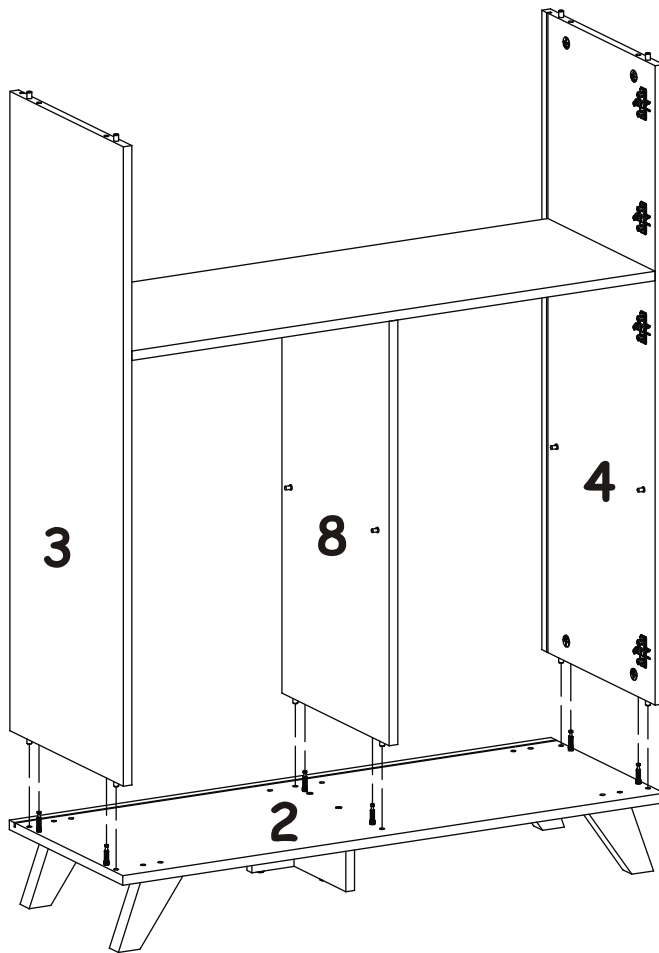

8

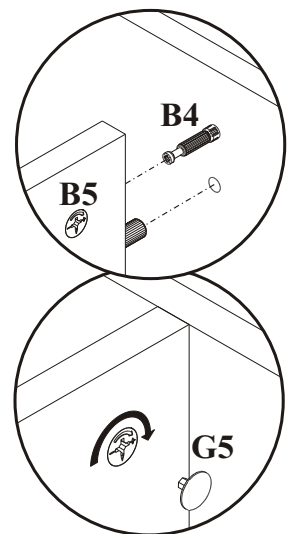
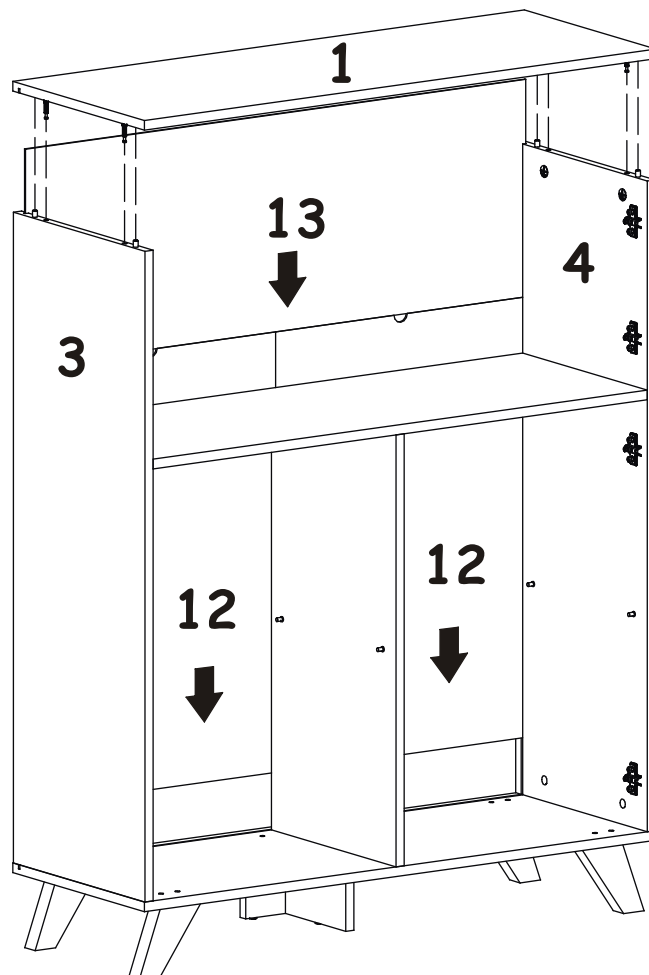

X=Y 

9

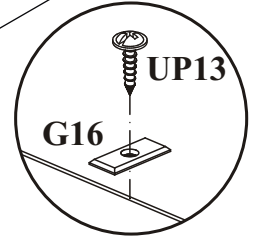
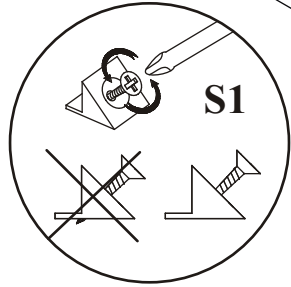
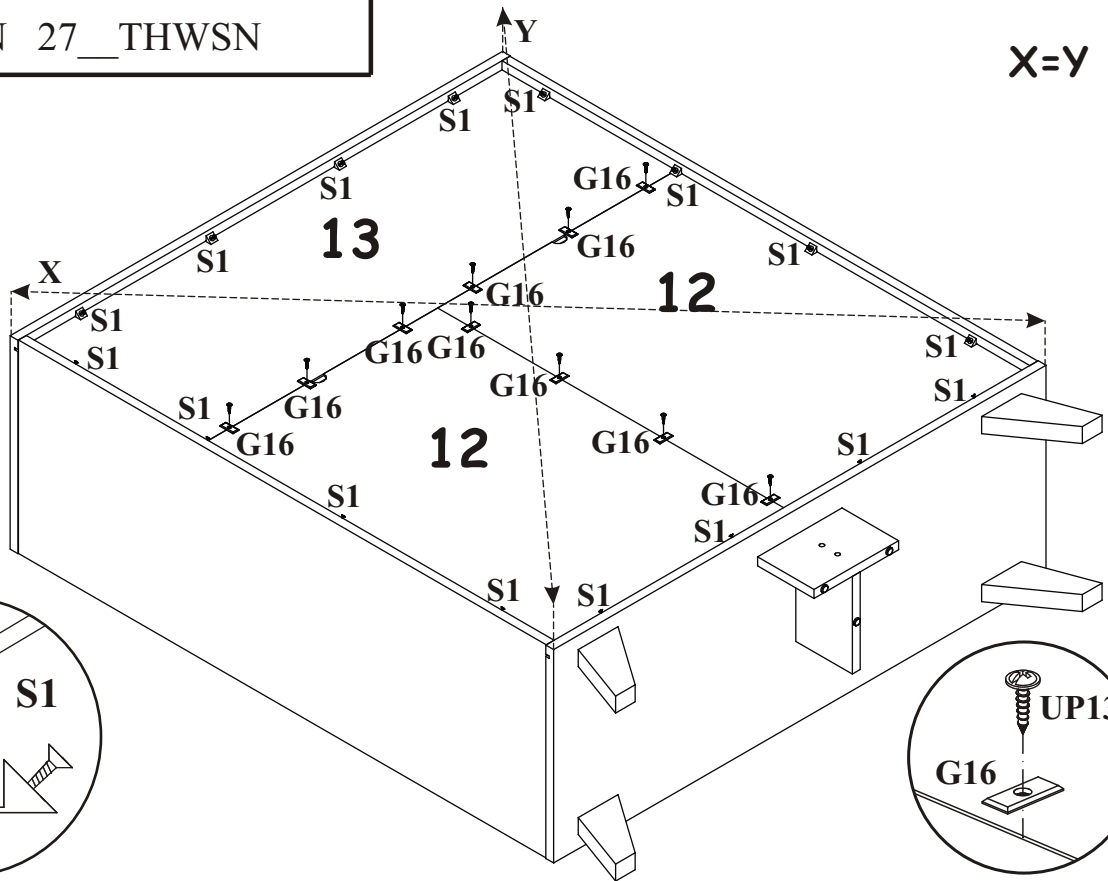

10

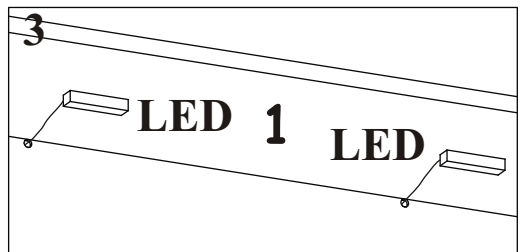
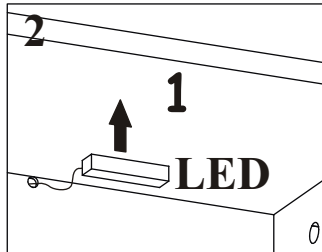
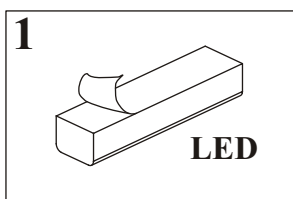
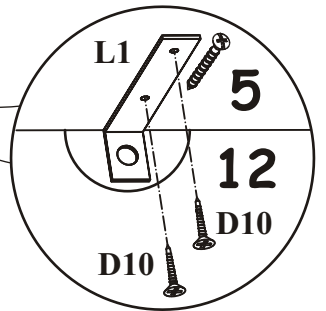
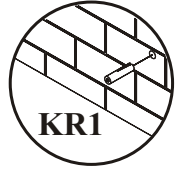
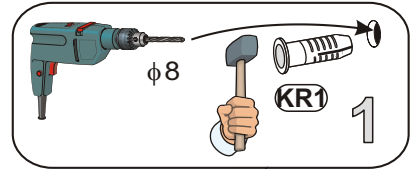
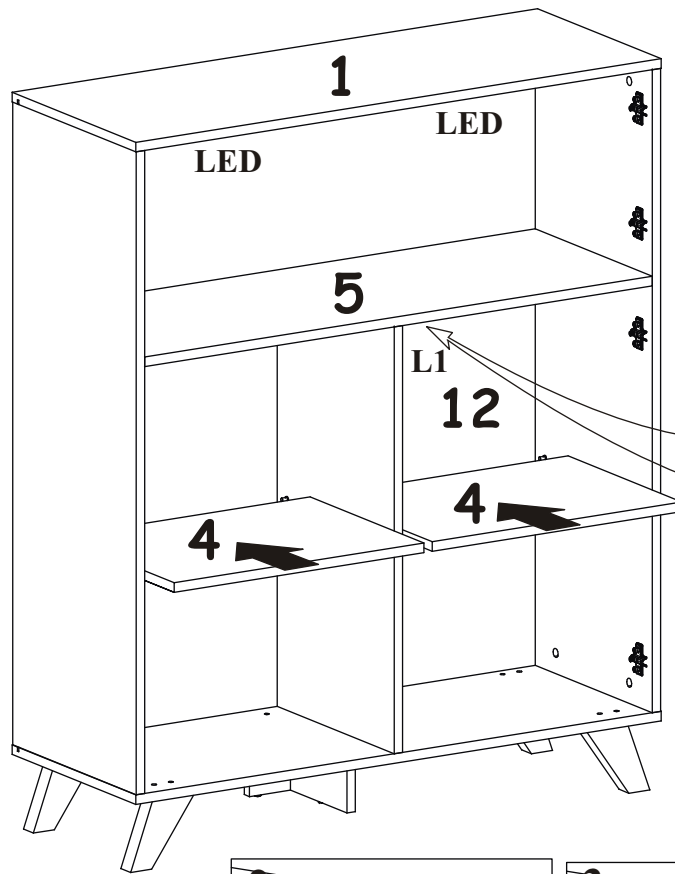
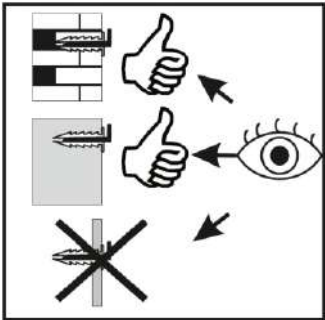

11

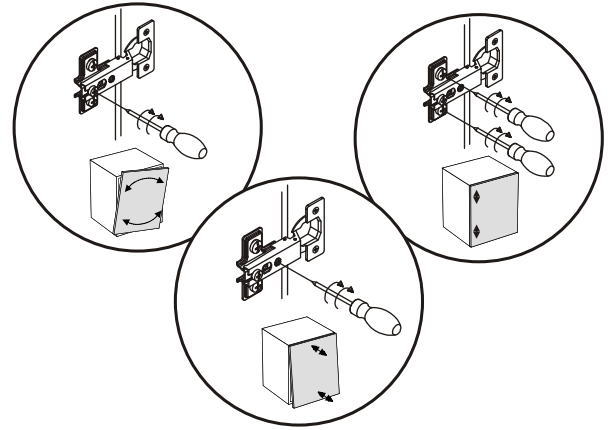
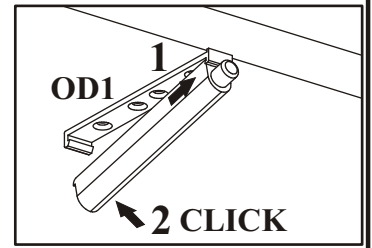
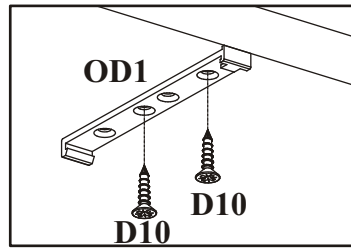
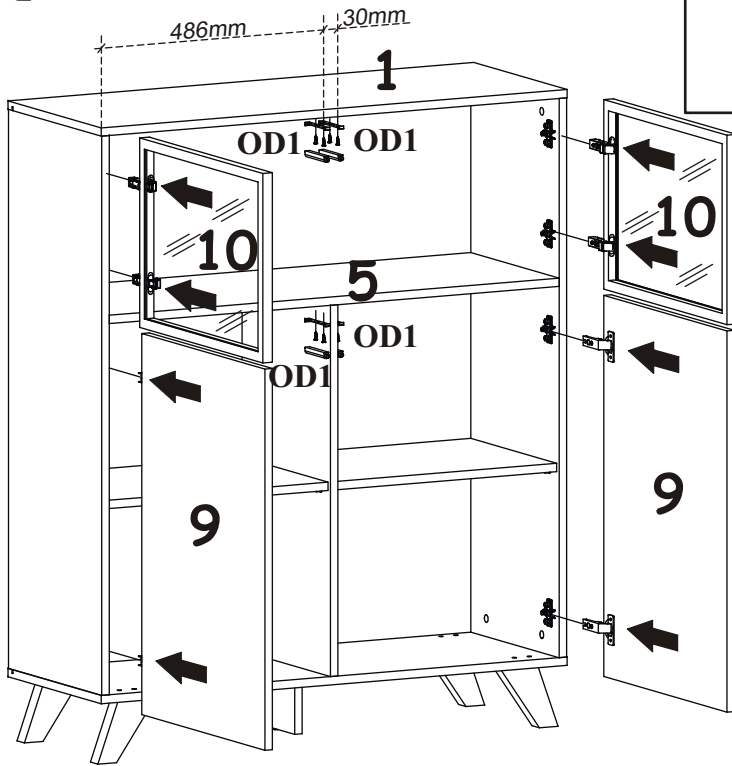

12

